

Vostro 15 3530

Owner's Manual

Notes, cautions, and warnings

 **NOTE:** A NOTE indicates important information that helps you make better use of your product.

 **CAUTION:** A CAUTION indicates either potential damage to hardware or loss of data and tells you how to avoid the problem.

 **WARNING:** A WARNING indicates a potential for property damage, personal injury, or death.

Chapter 1: Views of Vostro 15 3530	7
Right	7
Left	7
Top	9
Front	10
Bottom	12
Service Tag	12
Battery charge and status light	13
Chapter 2: Set up your Vostro 15 3530	14
Chapter 3: Specifications of Vostro 15 3530	16
Dimensions and weight	16
Processor	16
Chipset	17
Operating system	17
Memory	18
External ports	18
Internal slots	19
Ethernet	19
Wireless module	19
Audio	20
Storage	20
Media-card reader	21
Keyboard	21
Keyboard shortcuts of Vostro 15 3530	22
Camera	23
Touchpad	23
Power adapter	24
Battery	24
Display	26
Fingerprint reader (optional)	27
Sensor	27
GPU—Integrated	27
GPU—Discrete	27
Hardware security	28
Operating and storage environment	28
Dell Support policy	28
ComfortView	28
Chapter 4: Working inside your computer	30
Safety instructions	30
Before working inside your computer	30
Safety precautions	31

Electrostatic discharge—ESD protection.....	31
ESD field service kit	32
Transporting sensitive components.....	33
After working inside your computer.....	33
BitLocker.....	33
Recommended tools.....	34
Screw list.....	34
Major components of Vostro 15 3530.....	35
Chapter 5: Removing and installing Customer Replaceable Units (CRUs).....	38
Base cover.....	38
Removing the base cover.....	38
Installing the base cover	40
Memory module.....	42
Removing the memory module	42
Installing the memory module	43
M.2 solid-state drive.....	43
Removing the M.2 2230 solid-state drive	43
Installing the M.2 2230 solid-state drive	44
Removing the M.2 2280 solid-state drive	45
Installing the M.2 2280 solid-state drive	46
Wireless card.....	47
Removing the wireless card	47
Installing the wireless card	48
Speakers.....	50
Removing the speakers	50
Installing the speakers	51
Fan.....	53
Removing the fan	53
Installing the fan	54
Chapter 6: Removing and installing Field Replaceable Units (FRUs).....	55
Battery.....	55
Lithium-ion battery precautions.....	55
Removing the 3-cell battery	55
Installing the 3-cell battery	56
Removing the 4-cell battery	57
Installing the 4-cell battery	58
Disconnecting the battery cable	59
Connecting the battery cable	61
Heat sink.....	62
Removing the heat sink - integrated	62
Installing the heat sink	63
Removing the heat sink - discrete	64
Installing the heat sink - discrete	65
Touchpad.....	66
Removing the touchpad	66
Installing the touchpad	67
I/O daughter-board cable	68

Removing the I/O daughter-board cable.....	68
Installing the I/O daughter-board cable.....	69
I/O daughter-board.....	70
Removing the I/O daughter-board	70
Installing the I/O daughter-board	71
Power button.....	72
Removing the power button	72
Installing the power button	73
Power button with optional fingerprint reader.....	74
Removing the power button with optional fingerprint reader	74
Installing the power button with optional fingerprint reader	75
Power-adapter port.....	76
Removing the power-adapter port	76
Installing the power-adapter port	77
Display assembly.....	78
Removing the display assembly	78
Installing the display assembly	80
Display hinge caps.....	83
Removing the display hinge caps	83
Installing the display hinge caps	85
Display bezel.....	87
Removing the display bezel	87
Installing the display bezel	89
Display hinges.....	90
Removing the display hinges	90
Installing the display hinges	92
Display panel.....	93
Removing the display panel	93
Installing the display panel	98
Camera.....	101
Removing the camera.....	101
Installing the camera	101
Display cable.....	102
Removing the display cable	102
Installing the display cable	103
Display back-cover and antenna assembly.....	104
Removing the display back-cover and antenna assembly	104
Installing the display back-cover and antenna assembly	105
System board.....	107
Removing the system board	107
Installing the system board	109
Palm-rest and keyboard assembly.....	112
Removing the palm-rest and keyboard assembly	112
Installing the palm-rest and keyboard assembly	114
Chapter 7: Software.....	117
Operating system.....	117
Drivers and downloads.....	117

Chapter 8: BIOS setup	118
Entering BIOS setup program.....	118
Navigation keys.....	118
One time boot menu.....	118
System setup options.....	119
Updating the BIOS.....	124
Updating the BIOS in Windows.....	124
Updating the BIOS in Linux and Ubuntu.....	125
Updating the BIOS using the USB drive in Windows.....	125
Updating the BIOS from the F12 One-Time boot menu.....	125
System and setup password.....	126
Assigning a system setup password.....	126
Deleting or changing an existing system setup password.....	127
Clearing BIOS (System Setup) and System passwords.....	127
Chapter 9: Troubleshooting	128
Handling swollen Lithium-ion batteries.....	128
Locate the Service Tag or Express Service Code of your Dell computer	128
Dell SupportAssist Pre-boot System Performance Check diagnostics.....	129
Running the SupportAssist Pre-Boot System Performance Check.....	129
Built-in self-test (BIST).....	129
M-BIST.....	129
LCD Power rail test (L-BIST).....	130
LCD Built-in Self Test (BIST).....	130
System-diagnostic lights.....	131
Recovering the operating system.....	132
Real-Time Clock (RTC Reset).....	132
Backup media and recovery options.....	133
Wi-Fi power cycle.....	133
Drain residual flea power (perform hard reset).....	133
Chapter 10: Getting help and contacting Dell	134

Views of Vostro 15 3530

Right



1. SD-card slot

Reads from and writes to the SD card. The computer supports the following card types:

- Secure Digital (SD)
- Secure Digital High Capacity (SDHC)
- Secure Digital Extended Capacity (SDXC)

2. USB 2.0 port

Connect devices such as external storage devices and printers. Provides data transfer speeds up to 480 Mbps.

3. Network port

Connect an Ethernet (RJ45) cable from a router or a broadband modem for network or Internet access, with a transfer rate of 10/100/1000 Mbps.

4. Universal audio port

Connect headphones or a headset (headphone and microphone combo).

5. Security-cable slot (wedge-shaped)

Connect a security cable to prevent unauthorized movement of your computer.

Left



Figure 1. For computers shipped with a plastic chassis

1. Power-adaptor port (primary power)

Connect a power adapter to provide power to your computer and charge the battery.

2. Power and battery-status light

Indicates the power state and battery state of the computer.

Solid white—Power adapter is connected and the battery is charging.

Solid amber—Battery charge is low or critical.

Off—Battery is fully charged.

NOTE: On certain computer models, the power and battery-status light are also used for diagnostics. For more information, see the *Troubleshooting* section in your computer's *Service Manual*.

3. HDMI 1.4 port

Connect to a TV, external display or another HDMI-in enabled device. Provides video and audio output.

4. USB 3.2 Gen 1 port

Connect devices such as external storage devices and printers. Provides data transfer speeds up to 5 Gbps.

5. USB 3.2 Gen 1 (Type-C) port

Connect devices such as external storage devices and printers. Provides data transfer speeds up to 5 Gbps.



Figure 2. For computers shipped with an aluminum chassis or a discrete graphics card installed

1. Power-adapter port (primary power)

Connect a power adapter to provide power to your computer and charge the battery.

2. Power and battery-status light

Indicates the power state and battery state of the computer.

Solid white—Power adapter is connected and the battery is charging.

Solid amber—Battery charge is low or critical.

Off—Battery is fully charged.

NOTE: On certain computer models, the power and battery-status light are also used for diagnostics. For more information, see the *Troubleshooting* section in your computer's *Service Manual*.

3. HDMI 1.4 port

Connect to a TV, external display or another HDMI-in enabled device. Provides video and audio output.

4. USB 3.2 Gen 1 port

Connect devices such as external storage devices and printers. Provides data transfer speeds up to 5 Gbps.

5. USB 3.2 Gen 1 (Type-C) port with Power Delivery/DisplayPort

Connect devices such as external storage devices, printers, and external displays.

Supports Power Delivery that enables two-way power supply between devices. Provides up to 15 W power output that enables faster charging.

NOTE: A USB Type-C to DisplayPort adapter (sold separately) is required to connect a DisplayPort device.

Top

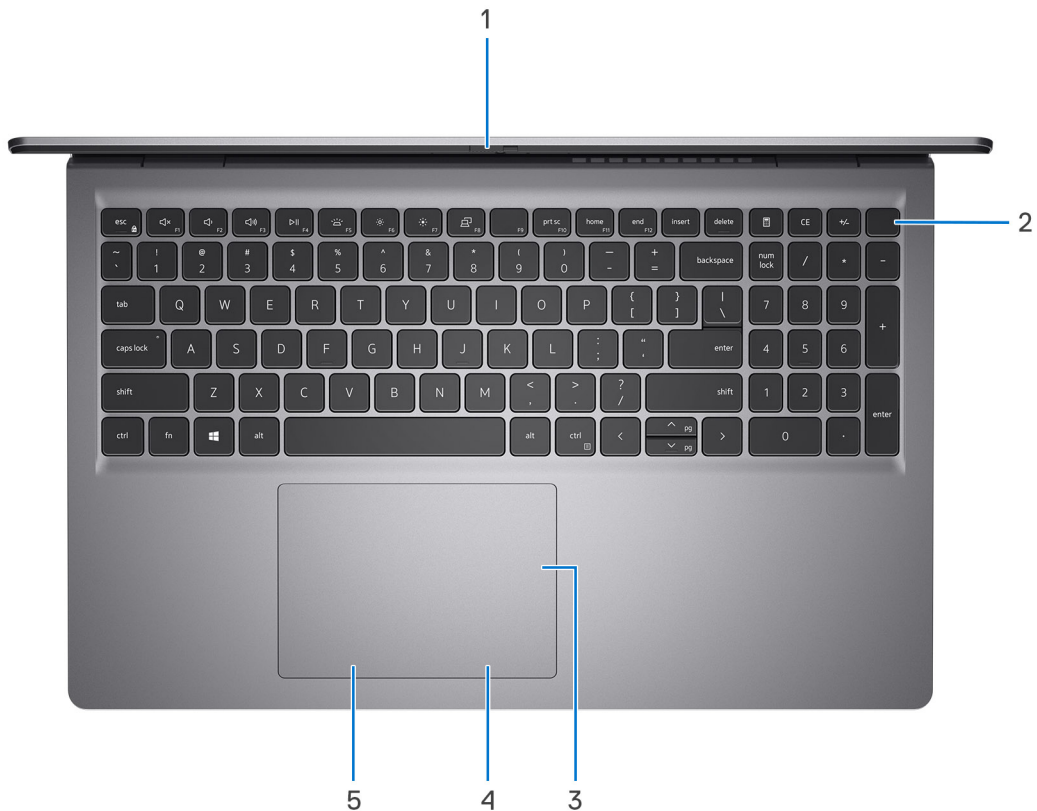

1. Privacy shutter (only for computers shipped with an aluminum chassis)

Slide the privacy shutter to cover the camera lens and protect your privacy when the camera is not in use.

2. Power button with optional fingerprint reader

Press to turn on the computer if it is turned off, in sleep state, or in hibernate state.

When the computer is turned on, press the power button to put the computer into sleep state; press and hold the power button for ten seconds to force shut-down the computer.

If the power button has a fingerprint reader, place your finger on the power button to log in.

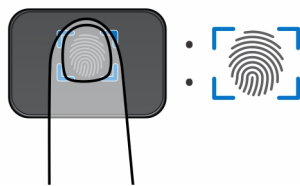

NOTE: The highlighted area indicates the actual active fingerprint reader area and the image is for illustration purposes only.

NOTE: You can customize power-button behavior in Windows. For more information, see www.dell.com/support/manuals.

3. Precision touchpad

Move your finger on the touchpad to move the mouse pointer. Tap to left-click and two fingers tap to right-click.

4. Right-click area

Press to right-click.

5. Left-click area

Press to left-click.

Front

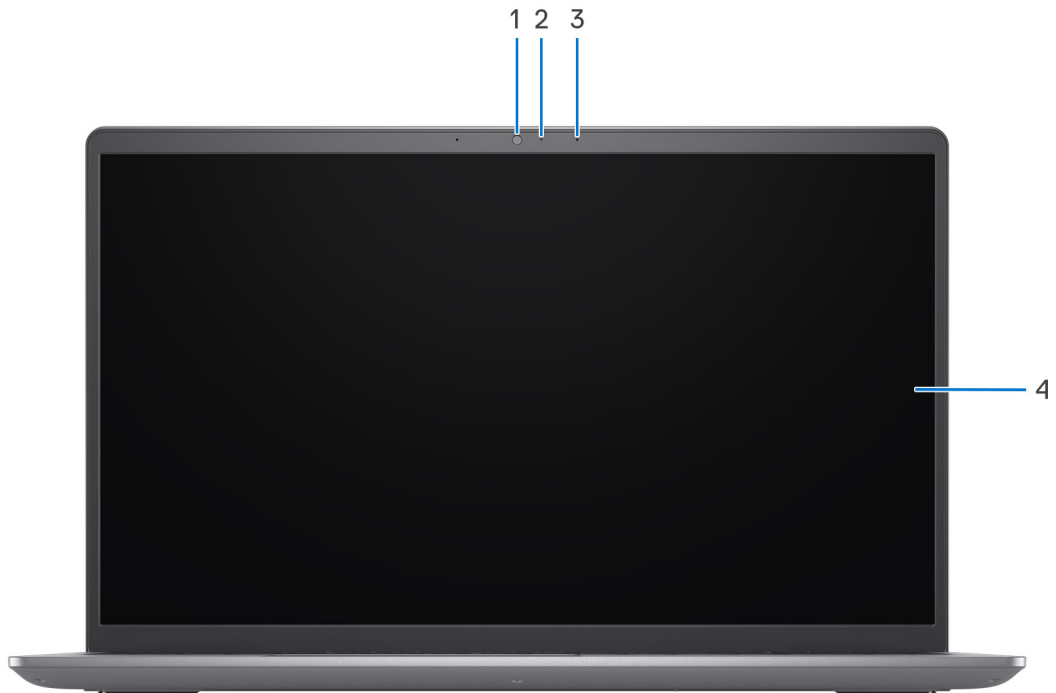

Figure 3. For computers shipped with a plastic chassis

- 1. Camera**
Enables you to video chat, capture photos, and record videos.
- 2. Camera-status light**
Turns on when the camera is in use.
- 3. Microphone**
Provides digital sound input for audio recording, voice calls, and so on.
- 4. Display**
Provides visual output.

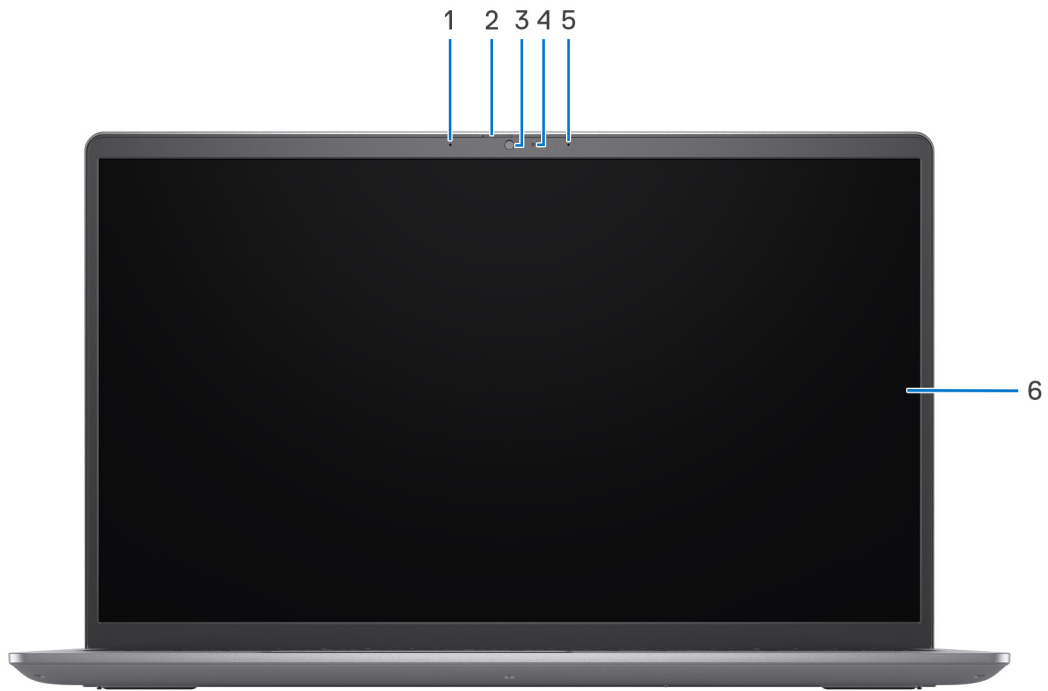

Figure 4. For computers shipped with an aluminum chassis

1. Left microphone

Provides digital sound input for audio recording and voice calls.

2. Privacy shutter

Slide the privacy shutter to cover the camera lens and protect your privacy when the camera is not in use.

3. Camera

Enables you to video chat, capture photos, and record videos.

4. Camera-status light

Turns on when the camera is in use.

5. Right microphone

Provides digital sound input for audio recording and voice calls.

6. Display

Provides visual output.

Bottom

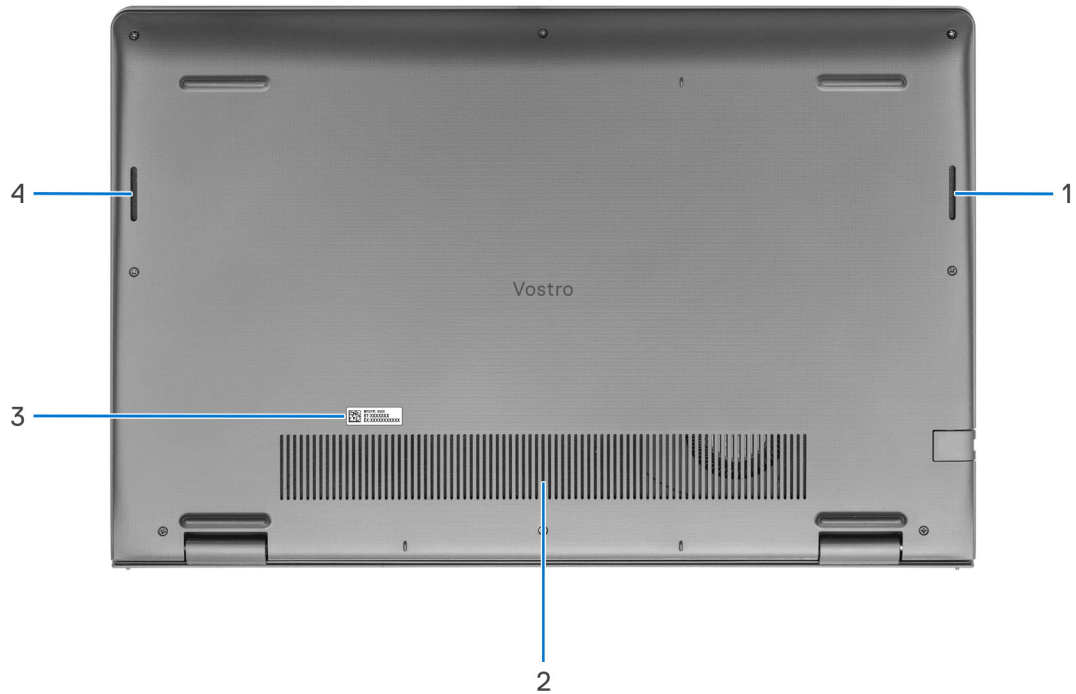

1. Right speaker

Provides audio output.

2. Air vents

Air vents provide ventilation for your computer. Clogged air vents can cause overheating and can affect your computer's performance and potentially cause hardware issues. Keep the air vents clear of obstructions and clean them regularly to prevent build-up of dust and dirt. For more information about cleaning air vents, search for articles in Knowledge Base Resource at www.dell.com/support.

3. Service Tag label

The Service Tag is a unique alphanumeric identifier that enables Dell service technicians to identify the hardware components in your computer and access warranty information.

4. Left speaker

Provides audio output.

Service Tag

The service tag is a unique alphanumeric identifier that allows Dell service technicians to identify the hardware components in your computer and access warranty information.

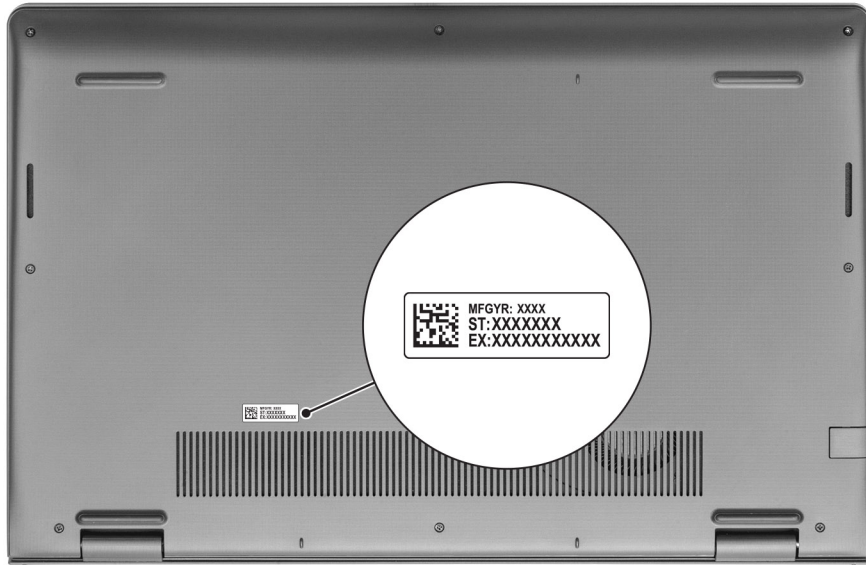

Battery charge and status light

The following table lists the battery charge and status light behavior of your Vostro 15 3530.

Table 1. Battery charge and status light behavior

Power Source	LED Behavior	System Power State	Battery Charge Level
AC Adapter	Off	S0 - S5	Fully Charged
AC Adapter	Solid White	S0 - S5	< Fully Charged
Battery	Off	S0 - S5	11-100%
Battery	Solid Amber (590+/-3 nm)	S0 - S5	< 10%

- S0 (ON) - System is turned on.
- S4 (Hibernate) - The system consumes the least power compared to all other sleep states. The system is almost at an OFF state, expect for a trickle power. The context data is written to hard drive.
- S5 (OFF) - The system is in a shutdown state.

Set up your Vostro 15 3530

About this task

NOTE: The images in this document may differ from your computer depending on the configuration you ordered.

Steps

1. Connect the power adapter and press the power button.



NOTE: To conserve battery power, the battery might enter power saving mode. Connect the power adapter and press the power button to turn on the computer.

2. Finish operating system setup.

For Ubuntu:

Follow the on-screen instructions to complete the setup. For more information about installing and configuring Ubuntu, search in the Knowledge Base Resource at www.dell.com/support.

For Windows:

Follow the on-screen instructions to complete the setup. When setting up, Dell recommends that you:







- Connect to a network for Windows updates.

NOTE: If connecting to a secured wireless network, enter the password for the wireless network access when prompted.

- If connected to the internet, sign-in with or create a Microsoft account. If not connected to the internet, create an offline account.
- On the **Support and Protection** screen, enter your contact details.

3. Locate and use Dell apps from the Windows Start menu—Recommended.

Table 2. Locate Dell apps

Resources	Description
	<p>Dell Product Registration Register your computer with Dell.</p>
	<p>Dell Help & Support Access help and support for your computer.</p>
	<p>My Dell Centralized location for key Dell applications, help articles, and other important information about your computer. It also notifies you about the warranty status, recommended accessories, and software updates if available.</p>
	<p>SupportAssist SupportAssist is the smart technology that keeps your computer running at its best by optimizing settings, detecting issues, removing viruses and notifies when you need to make system updates. SupportAssist proactively checks the health of your system's hardware and software. When an issue is detected, the necessary system state information is sent to Dell to begin troubleshooting. SupportAssist is preinstalled on most of the Dell devices running Windows operating system. For more information, see SupportAssist for Home PCs User's Guide on www.dell.com/serviceabilitytools.</p> <p>NOTE: In SupportAssist, click the warranty expiry date to renew or upgrade your warranty.</p>
	<p>Dell Update Updates your computer with critical fixes and latest device drivers as they become available. For more information on using Dell Update, search in the Knowledge Base Resource at www.dell.com/support.</p>
	<p>Dell Digital Delivery Download software applications, which are purchased but not preinstalled on your computer. For more information on using Dell Digital Delivery, search in the Knowledge Base Resource at www.dell.com/support.</p>

Specifications of Vostro 15 3530

Dimensions and weight

The following table lists the height, width, depth, and weight of your Vostro 15 3530.

Table 3. Dimensions and weight

Description	Computer shipped with a plastic chassis	Computer shipped with an aluminum chassis
Height:		
Front height	16.96 mm (0.67 in.)	15.52 mm (0.61 in.)
Rear height	19.00 mm (0.75 in.)	17.50 mm (0.69 in.)
Width	358.50 mm (14.11 in.)	358.50 mm (14.11 in.)
Depth	235.56 mm (9.27 in.)	234.90 mm (9.25 in.)
Weight (minimum)	1.66 kg (3.66 lb) i NOTE: The weight of your computer depends on the configuration ordered and manufacturing variability.	1.63 kg (3.60 lb) i NOTE: The weight of your computer depends on the configuration ordered and manufacturing variability.

Processor

The following table lists the details of the processors supported by your Vostro 15 3530.

Table 4. Processor

Description	Option one	Option two	Option three	Option four
Processor type	13 th Generation Intel Core i3-1305U	13 th Generation Intel Core i5-1335U	13 th Generation Intel Core i7-1355U	Intel Processor U300
Processor wattage	15 W	15 W	15 W	15 W
Processor total core count	5	10	10	5
Performance-cores	1	2	2	1
Efficient-cores	4	8	8	4
Processor total thread counts	6	12	12	6
i NOTE: Intel Hyper-Threading Technology is only available on Performance-cores.				

Table 4. Processor (continued)

Description	Option one	Option two	Option three	Option four
Processor speed	1.20 GHz to 4.50 GHz	0.90 GHz to 4.60 GHz	1.20 GHz to 5.00 GHz	0.90 GHz to 4.40 GHz
Performance-cores frequency				
Processor base frequency	1.60 GHz	1.30 GHz	1.70 GHz	1.20 GHz
Maximum turbo frequency	4.50 GHz	4.60 GHz	5.00 GHz	4.40 GHz
Efficient-cores frequency				
Processor base frequency	1.20 GHz	0.90 GHz	1.20 GHz	0.90 GHz
Maximum turbo frequency	3.30 GHz	3.40 GHz	3.70 GHz	3.30 GHz
Processor cache	10 MB	12 MB	12 MB	8 MB
Integrated graphics	Intel UHD Graphics	Intel Iris X ^e Graphics	Intel Iris X ^e Graphics	Intel UHD Graphics

Chipset

The following table lists the details of the chipset supported by your Vostro 15 3530

Table 5. Chipset

Description	Option one	Option two
Processors	13 th Generation Intel Core i3/i5/i7 processors and Intel Processor U300	13 th Generation Intel Core i5/i7 processors
Chipset	Integrated with the processor	Integrated with the processor
DRAM bus width	64-bit	64-bit
Flash EPROM	32 MB	32 MB
PCIe bus	Up to Gen 3	Up to Gen 4

Operating system

Your Vostro 15 3530 supports the following operating systems:

- Windows 11 Pro
- Windows 11 Pro National Academic
- Windows 11 Home
- Windows 11 Pro Downgrade (Windows 10 image factory installed)
- Ubuntu 22.04 LTS, 64-bit

Memory

The following table lists the memory specifications of your Vostro 15 3530.

Table 6. Memory specifications

Description	Values
Memory slots	Two SODIMM slots
Memory type	DDR4
Memory speed	<ul style="list-style-type: none"> 2666 MHz (for computers shipped with USB 3.2 Gen 1 Type-C port) 3200 MHz (for computers shipped with USB 3.2 Gen 1 Type-C port with DisplayPort Alt Mode 1.4/Power Delivery)
Maximum memory configuration	16 GB
Minimum memory configuration	4 GB
Memory size per slot	4 GB, 8 GB and 16 GB
Memory configurations supported	<p>For computers shipped with USB 3.2 Gen 1 Type-C port</p> <ul style="list-style-type: none"> 4 GB, 1 x 4 GB, DDR4, 2666 MHz 8 GB, 2 x 4 GB, DDR4, 2666 MHz, dual-channel 8 GB, 1 x 8 GB, DDR4, 2666 MHz 12 GB, 1 x 4 GB + 1 x 8 GB, DDR4, 2666 MHz, dual-channel 16 GB, 2 x 8 GB, DDR4, 2666 MHz, dual-channel 16 GB, 1 x 16 GB, DDR4, 2666 MHz <p>For computers shipped with USB 3.2 Gen 1 Type-C port with DisplayPort Alt Mode 1.4/Power Delivery</p> <ul style="list-style-type: none"> 4 GB, 1 x 4 GB, DDR4, 3200 MHz 8 GB, 2 x 4 GB, DDR4, 3200 MHz, dual-channel 8 GB, 1 x 8 GB, DDR4, 3200 MHz 12 GB, 1 x 4 GB + 1 x 8 GB, DDR4, 3200 MHz, dual-channel 16 GB, 2 x 8 GB, DDR4, 3200 MHz, dual-channel 16 GB, 1 x 16 GB, DDR4, 3200 MHz

External ports

The following table lists the external ports of your Vostro 15 3530.

Table 7. External ports

Description	Values
Network port	One Flip-Down RJ45 Ethernet port
USB ports	<ul style="list-style-type: none"> One USB 3.2 Gen 1 port One USB 2.0 port One USB 3.2 Gen 1 Type-C port (for computers shipped with a plastic chassis) One USB 3.2 Gen 1 Type-C port with DisplayPort Alt Mode 1.4/Power Delivery (for computers shipped with an aluminum chassis or a discrete graphics card installed)

Table 7. External ports (continued)

Description	Values
Audio port	One universal audio port
Video port	<ul style="list-style-type: none"> One HDMI 1.4 port One USB 3.2 Gen 1 Type-C port with DisplayPort Alt Mode 1.4/Power Delivery (for computers shipped with an aluminum chassis or a discrete graphics card installed)
Media-card reader	One SD-card slot
Power-adaptor port	One DC-in port (4.50 mm standard plug)
Security-cable slot	One wedge-shaped lock slot

Internal slots

The following table lists the internal slots of your Vostro 15 3530.

Table 8. Internal slots

Description	Values
M.2	<ul style="list-style-type: none"> One M.2 2230/2280 slot for solid-state drive One M.2 2230 slot for WLAN, Wi-Fi/Bluetooth <p>NOTE: To learn more about the features of different types of M.2 cards, search in the Knowledge Base Resource at www.dell.com/support.</p>

Ethernet

The following table lists the wired Ethernet Local Area Network (LAN) specifications of your Vostro 15 3530.

Table 9. Ethernet specifications

Description	Values
Model number	Integrated Realtek RTL8111H
Transfer rate	10/100/1000 Mbps

Wireless module

The following table lists the Wireless Local Area Network (WLAN) modules supported on your Vostro 15 3530.

Table 10. Wireless module specifications

Description	Option one	Option two
Model number	Realtek RTL8821CE	Realtek RTL8852BE
Transfer rate	Up to 433 Mbps	Up to 1201 Mbps
Frequency bands supported	2.40 GHz/5 GHz	2.40 GHz/5 GHz

Table 10. Wireless module specifications (continued)

Description	Option one	Option two
Wireless standards	<ul style="list-style-type: none"> • WiFi 802.11a/b/g • Wi-Fi 4 (WiFi 802.11n) • Wi-Fi 5 (WiFi 802.11ac) 	<ul style="list-style-type: none"> • WiFi 802.11a/b/g • Wi-Fi 4 (WiFi 802.11n) • Wi-Fi 5 (WiFi 802.11ac) • Wi-Fi 6 (WiFi 802.11ax)
Encryption	<ul style="list-style-type: none"> • 64-bit/128-bit WEP • AES-CCMP • TKIP 	<ul style="list-style-type: none"> • 64-bit/128-bit WEP • AES-CCMP • TKIP
Bluetooth wireless card	Supported	Supported

Audio

The following table lists the audio specifications of your Vostro 15 3530.

Table 11. Audio specifications

Description	Values	
Audio controller	There are two audio controller options: <ul style="list-style-type: none"> • Realtek ALC3204 • Realtek ALC3254 	
Stereo conversion	Supported	
Internal audio interface	High definition audio interface	
External audio interface	One universal audio port	
Number of speakers	Two	
Internal-speaker amplifier	Supported	
External volume controls	Keyboard shortcut controls	
Speaker output:		
	Average speaker output	2 W
	Peak speaker output	2.5 W
Subwoofer output	Not supported	
Microphone	<ul style="list-style-type: none"> • Single integrated microphone (for computers shipped with a plastic chassis) • Dual-array microphones (for computers shipped with an aluminum chassis) 	

Storage

This section lists the storage options on your Vostro 15 3530.

Your Vostro 15 3530 supports the following storage configurations:

- One M.2 2230/2280 solid-state drive

The M.2 2230/2280 solid-state drive is the primary drive of your computer.

Table 12. Storage specifications

Storage type	Interface type	Capacity
M.2 2230, Solid-state drive	PCIe NVMe Gen4 x4 QLC	Up to 1 TB
M.2 2230, Solid-state drive	PCIe NVMe Gen4 x4	Up to 1 TB
M.2 2280, Solid-state drive	PCIe NVMe Gen4 x4	Up to 2 TB

Media-card reader

The following table lists the media cards supported by your Vostro 15 3530.

Table 13. Media-card reader specifications

Description	Values
Media-card type	One SD-card slot
Media-cards supported	<ul style="list-style-type: none"> Secure Digital (SD) Secure Digital High Capacity (SDHC) Secure Digital Extended Capacity (SDXC)
<p> NOTE: The maximum capacity supported by the media-card reader varies depending on the standard of the media card installed in your computer.</p>	

Keyboard

The following table lists the keyboard specifications of your Vostro 15 3530.

Table 14. Keyboard specifications

Description	Values
Keyboard type	<ul style="list-style-type: none"> Standard backlit keyboard Standard non-backlit keyboard
Keyboard layout	QWERTY
Number of keys	<ul style="list-style-type: none"> United States and Canada: 99 keys United Kingdom: 100 keys Japan: 103 keys
Keyboard size	<p>X = 18.70 mm key pitch</p> <p>Y = 18.05 mm key pitch</p>
Keyboard shortcuts	<p>Some keys on your keyboard have two symbols on them. These keys can be used to type alternate characters or to perform secondary functions. To type the alternate character, press Shift and the desired key. To perform secondary functions, press Fn and the desired key.</p> <p> NOTE: You can define the primary behavior of the function keys (F1–F12) by changing Function Key Behavior in BIOS setup program.</p>

Keyboard shortcuts of Vostro 15 3530

NOTE: Keyboard characters may differ depending on the keyboard language configuration. Keys used for shortcuts remain the same across all language configurations.

Some keys on your keyboard have two symbols on them. These keys can be used to type alternate characters or to perform secondary functions. The symbol shown on the lower part of the key refers to the character that is typed out when the key is pressed. If you press shift and the key, the symbol shown on the upper part of the key is typed out. For example, if you press **2**, **2** is typed out; if you press **Shift + 2**, **@** is typed out.

The keys F1-F12 at the top row of the keyboard are function keys for multi-media control, as indicated by the icon at the bottom of the key. Press the function key to invoke the task represented by the icon. For example, pressing F1 mutes the audio (refer to the table below).

However, if the function keys F1-F12 are needed for specific software applications, multi-media functionality can be disabled by pressing **fn + Esc**. Subsequently, multi-media control can be invoked by pressing **fn** and the respective function key. For example, mute audio by pressing **fn + f1**.

NOTE: You can also define the primary behavior of the function keys (F1–F12) by changing **Function Key Behavior** in BIOS setup program.

Table 15. List of keyboard shortcuts

Function key	Primary behavior
F1	Mute audio
F2	Decrease volume
F3	Increase volume
F4	Play/Pause
F5	Click keyboard backlight (optional). NOTE: Non-backlight keyboards have F5 function key without the backlight icon and do not support toggle keyboard backlight function. NOTE: Toggle to cycle the keyboard backlight status through off, low-backlight, and high-backlight.
F6	Decrease brightness
F7	Increase brightness
F8	Switch to external display
F10	Print screen
F11	Home
F12	End

The **fn** key is also used with selected keys on the keyboard to invoke other secondary functions.

Table 16. Secondary behavior

Function key	Secondary behavior
fn + Esc	Toggle fn-key lock
fn + S	Toggle scroll lock
fn + B	Pause/Break
fn + R	System request
fn + Right ctrl	Open application menu
fn + / NOTE: This option is available only in Brazilian keyboard.	Open application menu

Table 16. Secondary behavior (continued)

Function key	Secondary behavior
fn + Space bar	Open emoji menu
fn + T	Toggle ultra performance mode
fn + Left arrow	Home
fn + Right arrow	End

Camera

The following table lists the camera specifications of your Vostro 15 3530.

Table 17. Camera specifications

Description	Computer shipped with plastic chassis	Computer shipped with aluminum chassis
Number of cameras	One	One
Camera type	There is one camera option: <ul style="list-style-type: none"> • HD RGB camera 	There is one camera option: <ul style="list-style-type: none"> • FHD RGB camera
Camera location	Front camera	Front camera
Camera sensor type	CMOS sensor technology	CMOS sensor technology
Camera resolution:		
Still image	0.92 megapixel	2.00 megapixel
Video	1280 x 720 (HD) at 30 fps	1920 x 1080 (FHD) at 30 fps
Diagonal viewing angle	78.60 degrees	82.00 degrees

Touchpad

The following table lists the touchpad specifications of your Vostro 15 3530.

Table 18. Touchpad specifications

Description	Values
Touchpad resolution:	
Horizontal	> 300 dpi
Vertical	> 300 dpi
Touchpad dimensions:	
Horizontal	115.00 mm (4.53 in.)
Vertical	80.00 mm (3.15 in.)
Touchpad gestures	For more information about touchpad gestures available on Windows, see the Microsoft knowledge base article at support.microsoft.com .

Power adapter

The following table lists the power adapter specifications of your Vostro 15 3530.

Table 19. Power adapter specifications

Description		Values
Type		65 W
Connector dimensions:		
	External diameter	4.50 mm (0.18 in.)
	Internal diameter	2.90 mm (0.11 in.)
Power-adapter dimensions:		
	Height	28.00 mm (1.10 in.)
	Width	47.00 mm (1.90 in.)
	Depth	108.00 mm (4.30 in.)
Power-adapter weight (maximum)		0.29 kg (0.64 lb)
Input voltage		100 VAC - 240 VAC
Input frequency		50 Hz - 60 Hz
Input current (maximum)		1.60 A/1.70 A
Output current (continuous)		3.34 A
Rated output voltage		19.50 VDC
Temperature range:		
	Operating	0°C to 40°C (32°F to 104°F)
	Storage	-40°C to 70°C (-40°F to 158°F)
 CAUTION: Operating and storage temperature ranges may differ among components, so operating or storing the device outside these ranges may impact the performance of specific components.		

Battery

The following table lists the battery specifications of your Vostro 15 3530.

Table 20. Battery specifications

Description	Option one	Option two
Battery type	3-cell, 41 Wh, lithium-polymer, ExpressCharge	4-cell, 54 Wh, lithium-polymer, ExpressCharge
Battery voltage	11.25 VDC	15.00 VDC
Battery weight (maximum)	0.19 kg (0.41 lb)	0.24 kg (0.55 lb)
Battery dimensions:		

Table 20. Battery specifications (continued)

Description		Option one	Option two
	Height	206.40 mm (8.12 in.)	271.90 mm (10.70 in.)
	Width	82.00 mm (3.22 in.)	82.00 mm (3.22 in.)
	Depth	5.75 mm (0.22 in.)	5.75 mm (0.22 in.)
Temperature range:			
	Operating	<p>When charging battery:</p> <ul style="list-style-type: none"> Initiating charging: 0°C to 45°C (32°F to 113°F) Upper limit for charging (maximum): 50°C (122°F) <p>When discharging battery:</p> <ul style="list-style-type: none"> Normal discharging: 0°C to 60°C (32°F to 140°F) Over temperature protection (maximum): 70°C (158°F) <p>i NOTE: The battery does not allow discharge past this temperature.</p>	<p>When charging battery:</p> <ul style="list-style-type: none"> Initiating charging: 0°C to 45°C (32°F to 113°F) Upper limit for charging (maximum): 50°C (122°F) <p>When discharging battery:</p> <ul style="list-style-type: none"> Normal discharging: 0°C to 60°C (32°F to 140°F) Over temperature protection (maximum): 70°C (158°F) <p>i NOTE: The battery does not allow discharge past this temperature.</p>
	Storage	-20°C to 60°C (-4°F to 140°F)	-20°C to 60°C (-4°F to 140°F)
Battery operating time		Varies depending on operating conditions and can significantly reduce under certain power-intensive conditions.	Varies depending on operating conditions and can significantly reduce under certain power-intensive conditions.
Battery charging time (approximate) i NOTE: Control the charging time, duration, start and end time, and so on using the Dell Power Manager application. For more information about Dell Power Manager, search in the Knowledge Base Resource at www.dell.com/support .		<p>Standard Charge/Predominately AC User Charge Method:</p> <ul style="list-style-type: none"> 0 - 15°C maximum allowable charge time from 0 to 100% RSOC is 4 hours 16 - 50°C maximum allowable charge time from 0 to 100% RSOC is 3 hours <p>Express Charge Method:</p> <ul style="list-style-type: none"> 0 - 15°C maximum allowable charge time from 0 to 100% RSOC is 4 hours 16 - 45°C normal express charge 46 - 50°C maximum allowable charge time from 0 to 80% RSOC is 1 hours charge time from 0 to 100% RSOC is 2 hours <p>Express Charge Boost Charge Method (Fast Charge for Initial 35%):</p> <ul style="list-style-type: none"> 16 - 45°C target charge time from 0 to 35% RSOC is 20 mins 	<p>Standard Charge/Predominately AC User Charge Method:</p> <ul style="list-style-type: none"> 0 - 15°C maximum allowable charge time from 0 to 100% RSOC is 4 hours 16 - 50°C maximum allowable charge time from 0 to 100% RSOC is 3 hours <p>Express Charge Method:</p> <ul style="list-style-type: none"> 0 - 15°C maximum allowable charge time from 0 to 100% RSOC is 4 hours 16 - 45°C normal express charge 46 - 50°C maximum allowable charge time from 0 to 80% RSOC is 1 hours charge time from 0 to 100% RSOC is 2 hours <p>Express Charge Boost Charge Method (Fast Charge for Initial 35%):</p> <ul style="list-style-type: none"> 16 - 45°C target charge time from 0 to 35% RSOC is 20 mins
Coin-cell battery		Not supported	Not supported
<p>⚠ CAUTION: Operating and storage temperature ranges may differ among components, so operating or storing the device outside these ranges may impact the performance of specific components.</p>			

Table 20. Battery specifications (continued)

Description	Option one	Option two
 CAUTION: Dell recommends that you charge the battery regularly for optimal power consumption. If your battery charge is completely depleted, connect the power adapter, turn on your computer, and then restart your computer to reduce the power consumption.		

Display

The following table lists the display specifications of your Vostro 15 3530.

Table 21. Display specifications

Description	Option one	Option two
Display type	15.6-inch High Definition (HD)	15.6-inch Full High Definition (FHD)
Touch options	No	No
Display-panel technology	Twisted Nematic (TN)	In-Plane Switching (IPS)
Display-panel dimensions (active area):		
	Height	193.54 mm (7.62 in.)
	Width	344.23 mm (13.55 in.)
	Diagonal	394.91 mm (15.55 in.)
Display-panel native resolution	1366 x 768	1920 x 1080
Luminance (typical)	220 nits	250 nits
Megapixels	1.05	2.07
Color gamut	45% NTSC	45% NTSC
Pixels Per Inch (PPI)	100	141
Contrast ratio (min.)	400:1	600:1
Response time (max.)	20 ms	35 ms
Refresh rate	60 Hz	120 Hz
Horizontal view angle	40 +/- degrees (min.)	80 +/- degrees (min.)
Vertical view angle	10 (Top)/30 (Bottom) degrees (min.)	80 +/- degrees (min.)
Pixel pitch	0.252 mm x 0.252 mm	0.17925 mm x 0.17925 mm
Power consumption (maximum)	4.20 W	5.25 W
Anti-glare vs glossy finish	Anti-glare	Anti-glare

Fingerprint reader (optional)

The following table lists the specifications of the optional fingerprint reader of your Vostro 15 3530.

NOTE: The fingerprint reader is located on the power button.

Table 22. Fingerprint reader specifications

Description	Values
Fingerprint-reader sensor technology	Capacitive sensing
Fingerprint-reader sensor resolution	500 dpi
Fingerprint-reader sensor pixel size	108 x 88 pixel

Sensor

The following table lists the sensor of your Vostro 15 3530.

Table 23. Sensor

Sensor support
Adaptive Thermal Performance Accelerometer

GPU—Integrated

The following table lists the specifications of the integrated Graphics Processing Unit (GPU) supported by your Vostro 15 3530.

Table 24. GPU—Integrated

Controller	Memory size	Processor
Intel UHD Graphics	Shared system memory	13 th Generation Intel Core i3 processors and Intel Processor U300
Intel Iris X ^e Graphics	Shared system memory (dual-channel)	13 th Generation Intel Core i5/i7 processors

GPU—Discrete

The following table lists the specifications of the discrete Graphics Processing Unit (GPU) supported by your Vostro 15 3530.

Table 25. GPU—Discrete

Controller	Memory size	Memory type
NVIDIA GeForce MX550	2 GB	GDDR6

Hardware security

The following table lists the hardware security of your Vostro 15 3530.

Table 26. Hardware security

Hardware security
Windows 10 Hello - Fingerprint Reader (optional)
Trusted Platform Module TPM 2.0
Wedge-shaped lock
Mechanical camera shutter (only for computers shipped with an aluminum chassis)

Operating and storage environment

This table lists the operating and storage specifications of your Vostro 15 3530.

Airborne contaminant level: G1 as defined by ISA-S71.04-1985

Table 27. Computer environment

Description	Operating	Storage
Temperature range	0°C to 35°C (32°F to 95°F)	-40°C to 65°C (-40°F to 149°F)
Relative humidity (maximum)	10% to 90% (non-condensing)	0% to 95% (non-condensing)
Vibration (maximum)*	0.66 GRMS	1.30 GRMS
Shock (maximum)	110 G†	160 G†
Altitude range	0 m to 3048 m (0 ft to 10000 ft)	0 m to 10668 m (0 ft to 35000 ft)
 CAUTION: Operating and storage temperature ranges may differ among components, so operating or storing the device outside these ranges may impact the performance of specific components.		

* Measured using a random vibration spectrum that simulates user environment.

† Measured using a 2 ms half-sine pulse.

Dell Support policy

For information on Dell support policy, search in the Knowledge Base Resource at www.dell.com/support.

ComfortView

 **WARNING: Prolonged exposure to blue light from the display may lead to long-term effects such as eye strain, eye fatigue, or damage to the eyes.**

Blue light is a color in the light spectrum which has a short wavelength and high energy. Chronic exposure to blue light, particularly from digital sources, may disrupt sleep patterns and cause long-term effects such as eye strain, eye fatigue, or damage to the eyes.

ComfortView mode can be enabled and configured using the Dell CinemaColor application.

ComfortView mode complies with TÜV Rheinland's requirement for low blue light software solution displays.

Low blue light: Dell ComfortView software technology reduces harmful blue light emissions to make extended screen time easy on your eyes.











To reduce the risk of eye strain, it is also recommended that you:

- Position the display at a comfortable viewing distance between 20 and 28 inches (50 and 70 cm) from your eyes.
- Blink frequently to moisten your eyes, wet your eyes with water, or apply suitable eye drops.
- Look away from your display, and gaze at a distant object at 20 ft (609.60 cm) away for at least 20 seconds during each break.
- Take an extended break for 20 minutes every two hours.

Working inside your computer



Safety instructions

Use the following safety guidelines to protect your computer from potential damage and to ensure your personal safety. Unless otherwise noted, each procedure included in this document assumes that you have read the safety information that shipped with your computer.

-  **WARNING:** Before working inside your computer, read the safety information that is shipped with your computer. For more safety best practices, see the Regulatory Compliance home page at www.dell.com/regulatory_compliance.
-  **WARNING:** Disconnect your computer from all power sources before opening the computer cover or panels. After you finish working inside the computer, replace all covers, panels, and screws before connecting your computer to an electrical outlet.
-  **CAUTION:** To avoid damaging the computer, ensure that the work surface is flat, dry, and clean.
-  **CAUTION:** To avoid damaging the components and cards, handle them by their edges, and avoid touching the pins and the contacts.
-  **CAUTION:** You should only perform troubleshooting and repairs as authorized or directed by the Dell technical assistance team. Damage due to servicing that is not authorized by Dell is not covered by your warranty. See the safety instructions that is shipped with the product or at www.dell.com/regulatory_compliance.
-  **CAUTION:** Before touching anything inside your computer, ground yourself by touching an unpainted metal surface, such as the metal at the back of the computer. While you work, periodically touch an unpainted metal surface to dissipate static electricity which could harm internal components.
-  **CAUTION:** When you disconnect a cable, pull it by its connector or its pull tab, not the cable itself. Some cables have connectors with locking tabs or thumbscrews that you must disengage before disconnecting the cable. When disconnecting cables, keep them evenly aligned to avoid bending the connector pins. When connecting cables, ensure that the ports and the connectors are correctly oriented and aligned.
-  **CAUTION:** Press and eject any installed card from the media-card reader.
-  **CAUTION:** Exercise caution when handling Lithium-ion batteries in laptops. Swollen batteries should not be used and should be replaced and disposed properly.
-  **NOTE:** The color of your computer and certain components may appear differently than shown in this document.

Before working inside your computer

Steps

1. Save and close all open files and exit all open applications.
2. Shut down your computer. For Windows operating system, click **Start** >  **Power** > **Shut down**.
 -  **NOTE:** If you are using a different operating system, see the documentation of your operating system for shut-down instructions.
3. Disconnect your computer and all attached devices from their electrical outlets.
4. Disconnect all attached network devices and peripherals, such as keyboard, mouse, and monitor from your computer.

5. Remove any media card and optical disk from your computer, if applicable.
6. Enter the service mode, if you are able to power on your computer.

Service Mode

Service Mode is used to cut-off power, without disconnecting battery cable from system board prior conducting repairs in the computer.

 **CAUTION:** If you are unable to turn on the computer to put it into Service Mode or the computer does not support Service Mode then proceed to disconnect the battery cable. To disconnect the battery cable, follow the steps in [Removing the battery](#).

 **NOTE:** Ensure that your computer is shut down and the AC adapter is disconnected.

- a. Hold **** key on the keyboard and press the power button for 3 seconds or until the Dell logo appears on the screen.
- b. Press any key to continue.
- c. If the AC adapter is not disconnected, a message prompting you to remove the AC adapter appears on the screen. Remove the AC adapter and then press any key to continue the **Service Mode** procedure. The **Service Mode** procedure automatically skips the following step if the **Owner Tag** of the computer is not set up in advance by the user.
- d. When the ready-to-proceed message appears on the screen, press any key to proceed. The computer emits three short beeps and shuts down immediately.
- e. Once the computer shuts down, it has successfully entered Service Mode.

 **NOTE:** If you are unable to power on your computer or unable to enter service mode skip this process.

Safety precautions

The safety precautions chapter details the primary steps to be taken before performing any disassembly instructions.

Observe the following safety precautions before you perform any installation or break/fix procedures involving disassembly or reassembly:

- Turn off the system and all attached peripherals.
- Disconnect the system and all attached peripherals from AC power.
- Disconnect all network cables, telephone, and telecommunications lines from the system.
- Use an ESD field service kit when working inside any notebook to avoid electrostatic discharge (ESD) damage.
- After removing any system component, carefully place the removed component on an anti-static mat.
- Wear shoes with non-conductive rubber soles to reduce the chance of getting electrocuted.

Standby power

Dell products with standby power must be unplugged before you open the case. Systems that incorporate standby power are essentially powered while turned off. The internal power enables the system to be remotely turned on (wake on LAN) and suspended into a sleep mode and has other advanced power management features.

Unplugging, pressing, and holding the power button for 15 seconds should discharge residual power in the system board.

Bonding

Bonding is a method for connecting two or more grounding conductors to the same electrical potential. This is done through the use of a field service electrostatic discharge (ESD) kit. When connecting a bonding wire, ensure that it is connected to bare metal and never to a painted or non-metal surface. The wrist strap should be secure and in full contact with your skin, and ensure that you remove all jewelry such as watches, bracelets, or rings prior to bonding yourself and the equipment.

Electrostatic discharge—ESD protection

ESD is a major concern when you handle electronic components, especially sensitive components such as expansion cards, processors, memory DIMMs, and system boards. Very slight charges can damage circuits in ways that may not be obvious, such as intermittent problems or a shortened product life span. As the industry pushes for lower power requirements and increased density, ESD protection is an increasing concern.

Due to the increased density of semiconductors used in recent Dell products, the sensitivity to static damage is now higher than in previous Dell products. For this reason, some previously approved methods of handling parts are no longer applicable.

Two recognized types of ESD damage are catastrophic and intermittent failures.

- **Catastrophic** – Catastrophic failures represent approximately 20 percent of ESD-related failures. The damage causes an immediate and complete loss of device functionality. An example of catastrophic failure is a memory DIMM that has received a static shock and immediately generates a "No POST/No Video" symptom with a beep code emitted for missing or nonfunctional memory.
- **Intermittent** – Intermittent failures represent approximately 80 percent of ESD-related failures. The high rate of intermittent failures means that most of the time when damage occurs, it is not immediately recognizable. The DIMM receives a static shock, but the tracing is merely weakened and does not immediately produce outward symptoms related to the damage. The weakened trace may take weeks or months to melt, and in the meantime may cause degradation of memory integrity, intermittent memory errors, etc.

The more difficult type of damage to recognize and troubleshoot is the intermittent (also called latent or "walking wounded") failure.

Perform the following steps to prevent ESD damage:

- Use a wired ESD wrist strap that is properly grounded. The use of wireless anti-static straps is no longer allowed; they do not provide adequate protection. Touching the chassis before handling parts does not ensure adequate ESD protection on parts with increased sensitivity to ESD damage.
- Handle all static-sensitive components in a static-safe area. If possible, use anti-static floor pads and workbench pads.
- When unpacking a static-sensitive component from its shipping carton, do not remove the component from the anti-static packing material until you are ready to install the component. Before unwrapping the anti-static packaging, ensure that you discharge static electricity from your body.
- Before transporting a static-sensitive component, place it in an anti-static container or packaging.

ESD field service kit

The unmonitored Field Service kit is the most commonly used service kit. Each Field Service kit includes three main components: anti-static mat, wrist strap, and bonding wire.

Components of an ESD field service kit

The components of an ESD field service kit are:

- **Anti-Static Mat** – The anti-static mat is dissipative and parts can be placed on it during service procedures. When using an anti-static mat, your wrist strap should be snug and the bonding wire should be connected to the mat and to any bare metal on the system being worked on. Once deployed properly, service parts can be removed from the ESD bag and placed directly on the mat. ESD-sensitive items are safe in your hand, on the ESD mat, in the system, or inside a bag.
- **Wrist Strap and Bonding Wire** – The wrist strap and bonding wire can be either directly connected between your wrist and bare metal on the hardware if the ESD mat is not required, or connected to the anti-static mat to protect hardware that is temporarily placed on the mat. The physical connection of the wrist strap and bonding wire between your skin, the ESD mat, and the hardware is known as bonding. Use only Field Service kits with a wrist strap, mat, and bonding wire. Never use wireless wrist straps. Always be aware that the internal wires of a wrist strap are prone to damage from normal wear and tear, and must be checked regularly with a wrist strap tester in order to avoid accidental ESD hardware damage. It is recommended to test the wrist strap and bonding wire at least once per week.
- **ESD Wrist Strap Tester** – The wires inside of an ESD strap are prone to damage over time. When using an unmonitored kit, it is a best practice to regularly test the strap prior to each service call, and at a minimum, test once per week. A wrist strap tester is the best method for doing this test. If you do not have your own wrist strap tester, check with your regional office to find out if they have one. To perform the test, plug the wrist-strap's bonding-wire into the tester while it is strapped to your wrist and push the button to test. A green LED is lit if the test is successful; a red LED is lit and an alarm sounds if the test fails.
- **Insulator Elements** – It is critical to keep ESD sensitive devices, such as plastic heat sink casings, away from internal parts that are insulators and often highly charged.
- **Working Environment** – Before deploying the ESD Field Service kit, assess the situation at the customer location. For example, deploying the kit for a server environment is different than for a desktop or portable environment. Servers are typically installed in a rack within a data center; desktops or portables are typically placed on office desks or cubicles. Always look for a large open flat work area that is free of clutter and large enough to deploy the ESD kit with additional space to accommodate the type of system that is being repaired. The workspace should also be free of insulators that can cause an ESD event. On the work area, insulators such as Styrofoam and other plastics should always be moved at least 12 inches or 30 centimeters away from sensitive parts before physically handling any hardware components

- **ESD Packaging** – All ESD-sensitive devices must be shipped and received in static-safe packaging. Metal, static-shielded bags are preferred. However, you should always return the damaged part using the same ESD bag and packaging that the new part arrived in. The ESD bag should be folded over and taped shut and all the same foam packing material should be used in the original box that the new part arrived in. ESD-sensitive devices should be removed from packaging only at an ESD-protected work surface, and parts should never be placed on top of the ESD bag because only the inside of the bag is shielded. Always place parts in your hand, on the ESD mat, in the system, or inside an anti-static bag.
- **Transporting Sensitive Components** – When transporting ESD sensitive components such as replacement parts or parts to be returned to Dell, it is critical to place these parts in anti-static bags for safe transport.

ESD protection summary

It is recommended to use the traditional wired ESD grounding wrist strap and protective anti-static mat at all times when servicing Dell products. In addition, it is critical to keep sensitive parts separate from all insulator parts while performing service and that they use anti-static bags for transporting sensitive components.

Transporting sensitive components

When transporting ESD sensitive components such as replacement parts or parts to be returned to Dell, it is critical to place these parts in anti-static bags for safe transport.

After working inside your computer

About this task

 **CAUTION:** Leaving stray or loose screws inside your computer may severely damage your computer.

Steps

1. Replace all screws and ensure that no stray screws remain inside your computer.
2. Connect any external devices, peripherals, or cables you removed before working on your computer.
3. Replace any media cards, discs, or any other parts that you removed before working on your computer.
4. Connect your computer and all attached devices to their electrical outlets.
 -  **NOTE:** To exit service mode, ensure to connect the AC adapter to the power-adaptor port on your computer.
5. Press the power button to turn on the computer. Your computer will automatically return to normal functioning mode.

BitLocker

 **CAUTION:** If BitLocker is not suspended before updating the BIOS, the next time you reboot the system it will not recognize the BitLocker key. You will then be prompted to enter the recovery key to progress, and the system will ask for this on each reboot. If the recovery key is not known this can result in data loss or an unnecessary operating system reinstall. For more information about this subject, For information on *updating the BIOS on Dell systems with BitLocker enabled*, search in the Knowledge Base Resource at www.dell.com/support.

 **CAUTION:** If BitLocker is not suspended, replacing parts like system board or storage drives on a system with BitLocker / Device encryption enabled will also trigger the encryption and lock the user out. The recovery key is required to regain access to Windows. The recovery key is automatically saved to the user's Microsoft Account (MSA) when the device is encrypted and can be retrieved from <https://account.microsoft.com/devices/recoverykey>

For more information, refer to Windows Support article: [Finding your BitLocker recovery key in Windows](#)

Recommended tools

The procedures in this document may require the following tools:

- Phillips screwdriver #0
- Plastic scribe

Screw list

NOTE: When removing screws from a component, it is recommended to note the screw type, the quantity of screws, and then place them in a screw storage box. This is to ensure that the correct number of screws and correct screw type is restored when the component is replaced.







NOTE: Some computers have magnetic surfaces. Ensure that the screws are not left attached to such surfaces when replacing a component.

NOTE: Screw color may vary with the configuration ordered.

Table 28. Screw list

Component	Screw type	Quantity	Screw image
Base cover	<ul style="list-style-type: none"> • M2x5 • Captive screw <p>NOTE: Screws are part of the base cover.</p>	<ul style="list-style-type: none"> • 6 • 2 	
Battery	M2x3	<ul style="list-style-type: none"> • 3-cell battery: 3 • 4-cell battery: 4 	
M.2 2230/2280 solid-state drive	M2x2	1	
Wireless-card bracket	M2x3.5	1	
Fan	M2x5	2	
Heat sink - integrated	Captive screw <p>NOTE: Screws are part of the integrated heat sink.</p>	4	
Heat sink - discrete	<ul style="list-style-type: none"> • Captive screw <p>NOTE: Screws are part of the discrete heat sink.</p> <ul style="list-style-type: none"> • M2x3 	<ul style="list-style-type: none"> • 4 • 3 	

Table 28. Screw list (continued)

Component	Screw type	Quantity	Screw image
Touchpad bracket	M2x2	3	
Touchpad	M2x2	2	
I/O daughter-board	M2x3.5	2	
Power button	M2x2	1	
Power button with optional fingerprint reader	M2x2	1	
Display assembly	M2.5x5	4	
Display hinges	M2.5x3.8	6	
System board	<ul style="list-style-type: none"> • M2x2 • M2x3.5 	<ul style="list-style-type: none"> • 1 • 4 	 <ul style="list-style-type: none"> •  • 
RF metal wall bracket <i>i</i> NOTE: Only for computers shipped with an aluminum chassis and a 4-cell battery installed.	M2x2	2	

Major components of Vostro 15 3530

The following image shows the major components of Vostro 15 3530.

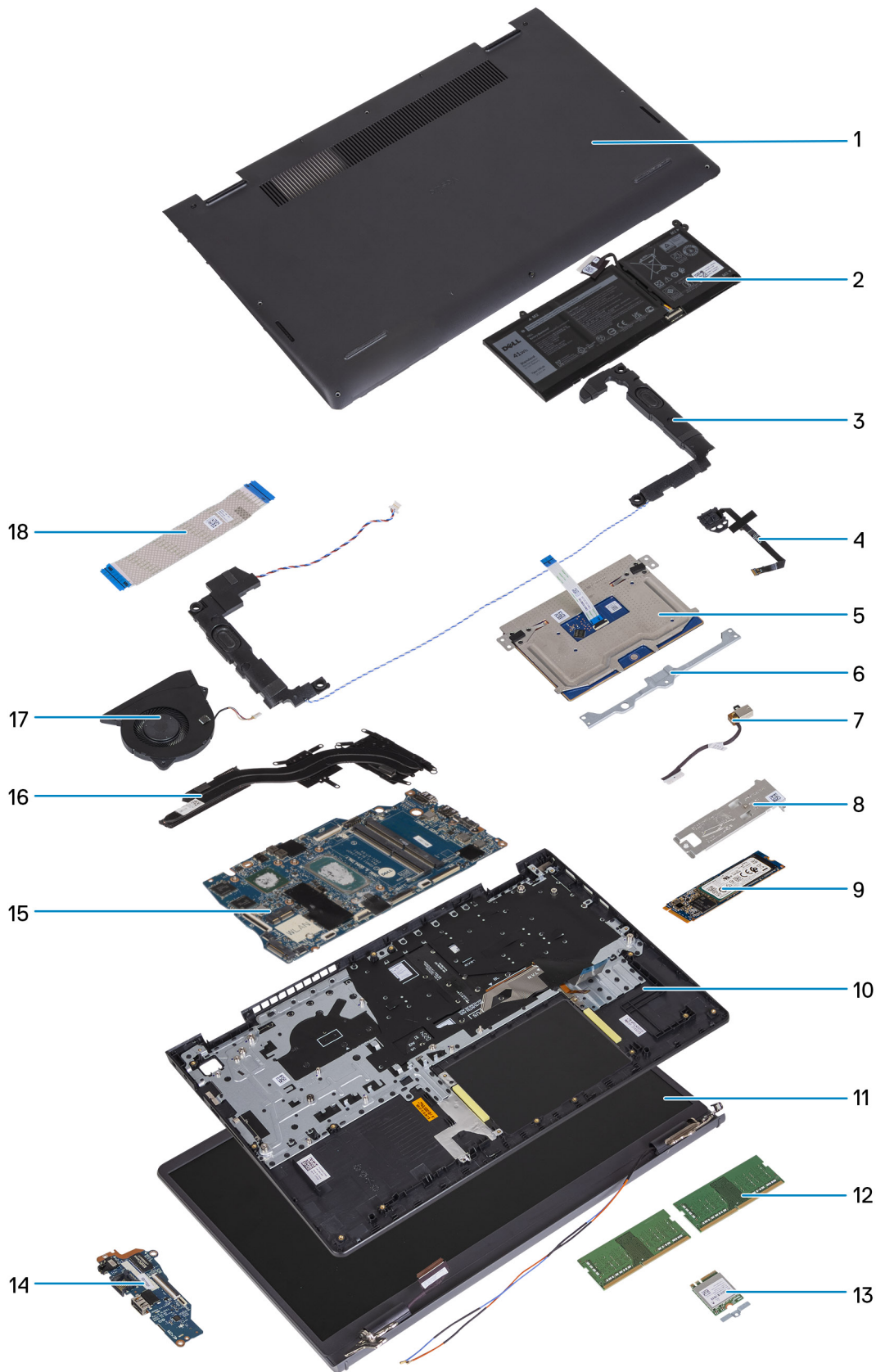

- | | |
|-----------------------|--|
| 1. Base cover | 2. Battery |
| 3. Speakers | 4. Power button with optional fingerprint reader |
| 5. Touchpad | 6. Touchpad bracket |
| 7. Power adapter port | 8. M.2 2280 solid-state drive thermal plate |

- 9. M.2 2280 solid-state drive
- 10. Palm-rest and keyboard assembly
- 11. Display assembly
- 12. Memory module
- 13. Wireless card
- 14. I/O daughter-board
- 15. System board
- 16. Heat sink
- 17. Fan
- 18. I/O daughter-board cable

 **NOTE:** Dell provides a list of components and their part numbers for the original system configuration purchased. These parts are available according to warranty coverages purchased by the customer. Contact your Dell sales representative for purchase options.

Removing and installing Customer Replaceable Units (CRUs)

The replaceable components in this chapter are Customer Replaceable Units (CRUs).

 **CAUTION:** Customers can replace only the Customer Replaceable Units (CRUs) following the safety precautions and replacement procedures.

 **NOTE:** The images in this document may differ from your computer depending on the configuration you ordered.

Base cover

Removing the base cover

Prerequisites

1. Follow the procedure in [Before working inside your computer](#).

 **NOTE:** Ensure that your computer is in Service Mode. For more information see, step 6 in [Before working inside your computer](#).

About this task

The following images indicate the location of the base cover and provide a visual representation of the removal procedure.



6x
M2x5



2x

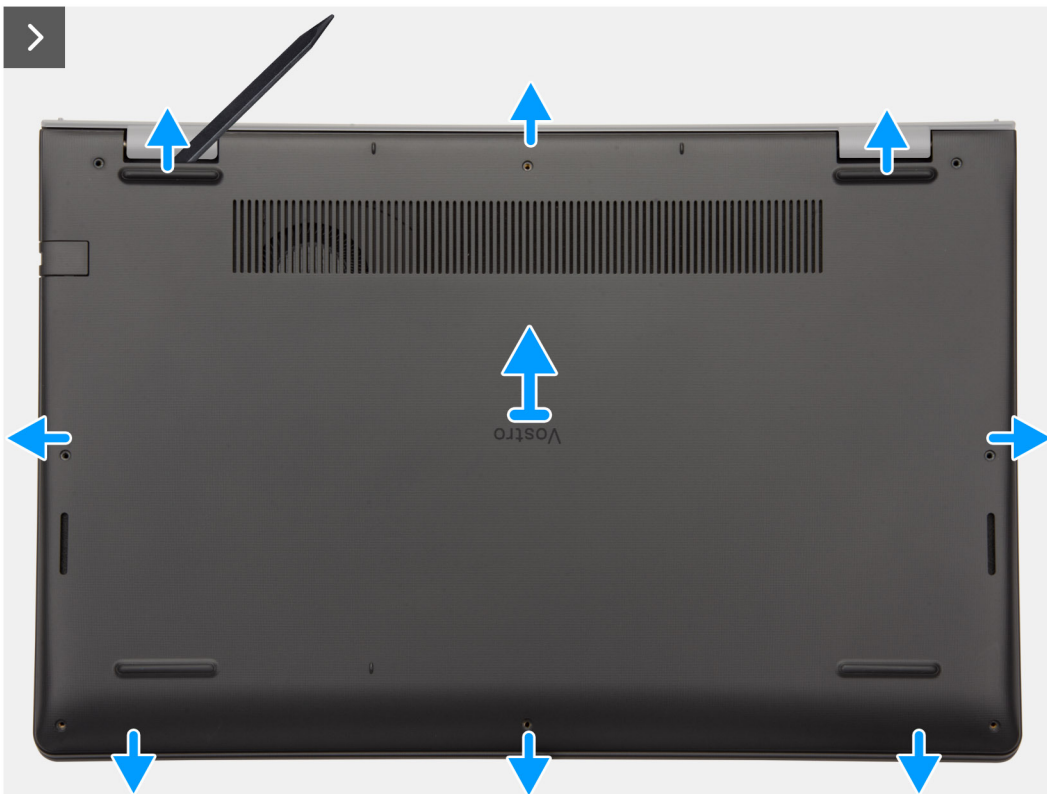

Steps

1. Remove the six screws (M2x5) and loosen the two captive screws that secure the base cover to the palm-rest and keyboard assembly.
2. Using a plastic scribe, pry open the base cover starting from the recesses, which are located in the U-shaped indents at the top edge of the base cover, near the hinges.

Please help reschedule the meeting to Tuesday.



3. Pry open the top side of the base cover and continue working on the left and right sides to open the base cover.
4. Lift and remove the base cover off the palm-rest and keyboard assembly.

Installing the base cover

Prerequisites

If you are replacing a component, remove the existing component before performing the installation procedure.

About this task

The following images indicate the location of the base cover and provide a visual representation of the installation procedure.

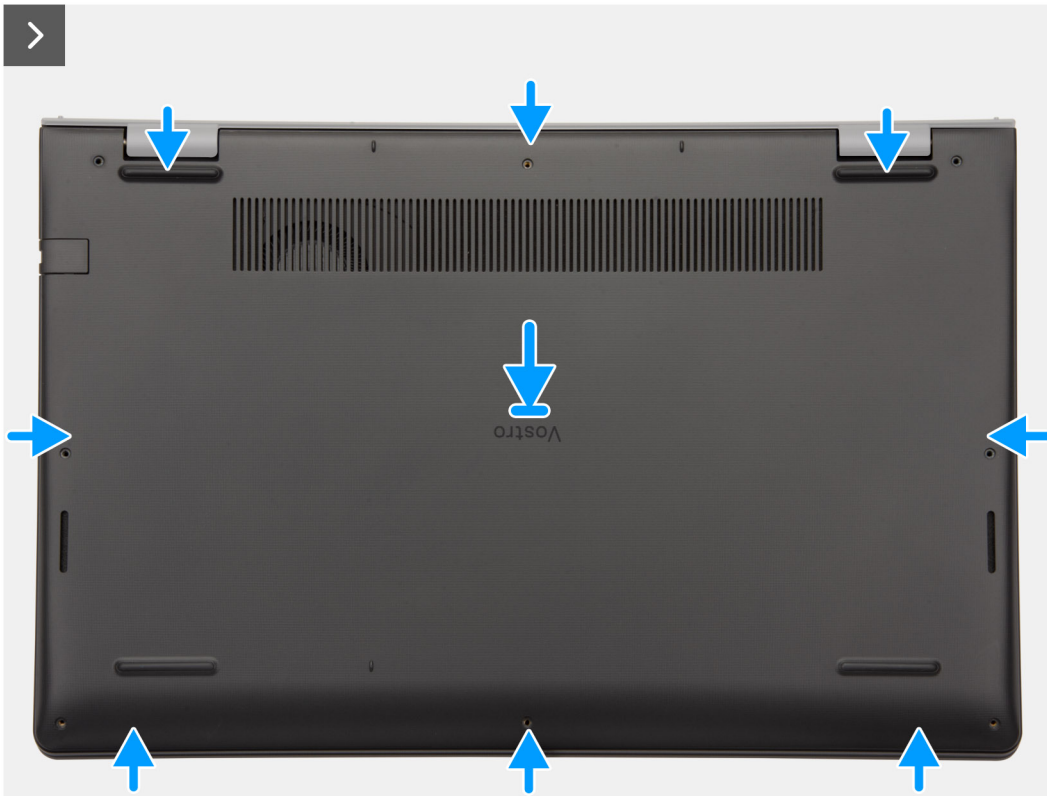

Steps

1. Place the base cover on top of the palm-rest and keyboard assembly.
2. Align the screw holes on the base cover with the screw holes on the palm-rest and keyboard assembly, and snap the base cover latches into place.
3. Tighten the two captive screws and replace the six screws (M2x5) to secure the base cover to the palm-rest and keyboard assembly.

Next steps

1. Follow the procedure in [After working inside your computer](#).

Memory module

Removing the memory module

Prerequisites

1. Follow the procedure in [Before working inside your computer](#).
2. Remove the [base cover](#).

About this task

The following images indicate the location of the memory module and provide a visual representation of the removal procedure.

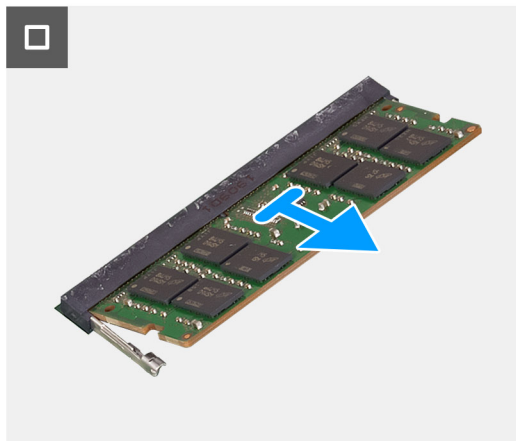
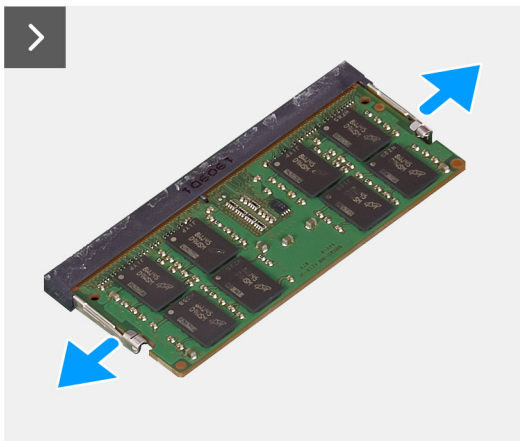
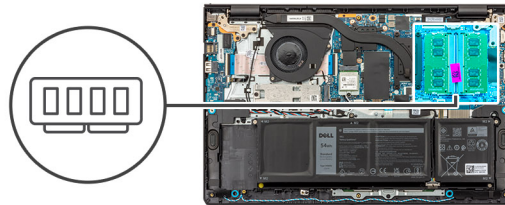

Steps

1. Using a plastic scribe, carefully pry the memory-module retention clips away from the memory module until the memory module pops-up.
2. Slide the memory module at an angle and remove it from the memory-module slot on the system board.
3. Repeat step 1 and 2 for the second memory module, if installed.

Installing the memory module

Prerequisites

If you are replacing a component, remove the existing component before performing the installation procedure.

About this task

The following images indicate the location of the memory module and provide a visual representation of the installation procedure.

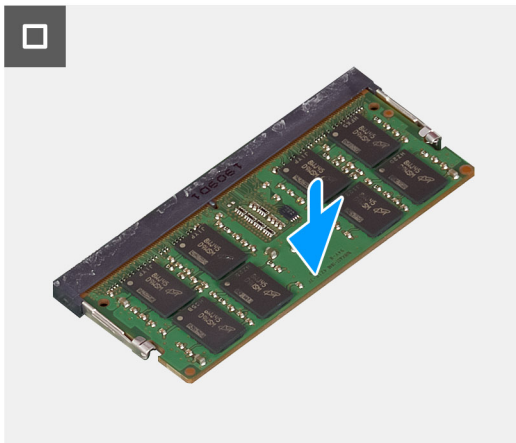
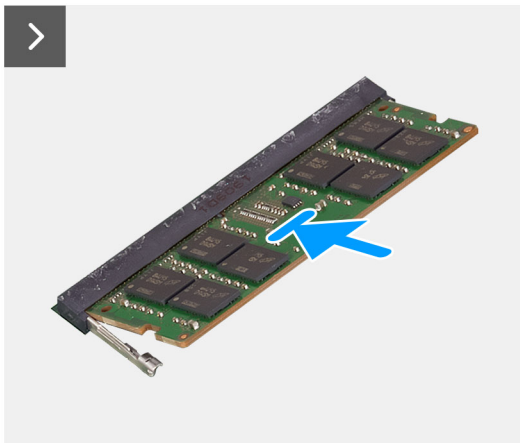
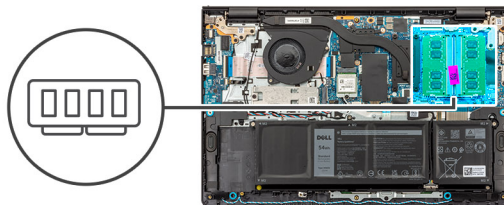

Steps

1. Align the notch on the memory module with the tab on the memory-module slot on the system board.
2. Slide the memory module firmly into the memory-module slot at an angle.
3. Press down on the memory module to snap it on the system board. Ensure that the memory-module retention clips have locked the memory module.

NOTE: If you do not hear the click, remove the memory module and reinstall it.

4. Repeat steps 1, 2 and 3 to install the second memory module, if applicable.

Next steps

1. Install the [base cover](#).
2. Follow the procedure in [After working inside your computer](#).

M.2 solid-state drive

Removing the M.2 2230 solid-state drive

Prerequisites

1. Follow the procedure in [Before working inside your computer](#).
2. Remove the [base cover](#).

About this task

NOTE: This procedure applies only to computers shipped with a M.2 2230 solid-state drive installed.

NOTE: The M.2 card that is installed on your system depends on the configuration ordered. Supported card configurations on the M.2 card slot are:

- M.2 2230 solid-state drive
- M.2 2280 solid-state drive

The following images indicate the location of the M.2 2230 solid-state drive and provide a visual representation of the removal procedure.

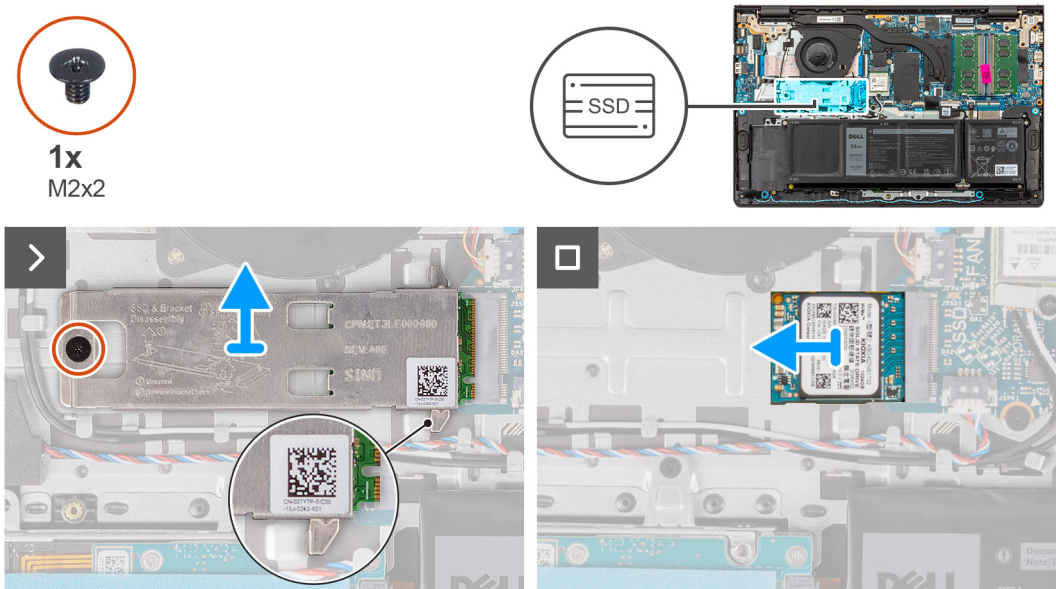

Steps

1. Remove the screw (M2x2) that secures the M.2 2230 solid-state drive thermal plate to the palm-rest and keyboard assembly.
2. Slide and remove the M.2 2230 solid-state drive thermal plate from the M.2 2230 solid-state drive.
3. Slide and remove the M.2 2230 solid-state drive from the M.2 card slot on the system board.

Installing the M.2 2230 solid-state drive

Prerequisites

If you are replacing a component, remove the existing component before performing the installation procedure.

About this task

The following images indicate the location of the M.2 2230 solid-state drive and provide a visual representation of the installation procedure.



1x
M2x2

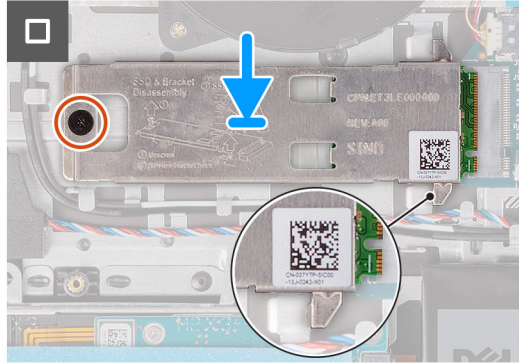
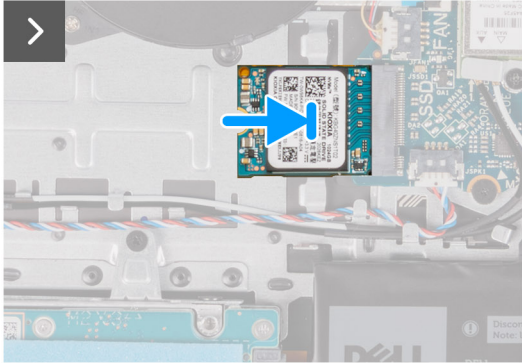

Steps

1. Align the notch on the M.2 2230 solid-state drive with the tab on the M.2 card slot on the system board.
2. Slide the M.2 2230 solid-state drive in the M.2 card slot on the system board.
3. Place the M.2 2230 solid-state drive thermal plate on the M.2 2230 solid-state drive.
i **NOTE:** When installing the M.2 2230 solid-state drive thermal plate on the system, tuck the tabs on the M.2 2230 solid-state drive thermal plate under the hooks on the palm-rest and keyboard assembly.
4. Align the screw hole on the M.2 2230 solid-state drive thermal plate with the screw hole on the palm-rest and keyboard assembly.
5. Replace the screw (M2x2) to secure the M.2 2230 solid-state drive thermal plate to the palm-rest and keyboard assembly.

Next steps

1. Install the [base cover](#).
2. Follow the procedure in [After working inside your computer](#).

Removing the M.2 2280 solid-state drive

Prerequisites

1. Follow the procedure in [Before working inside your computer](#).
2. Remove the [base cover](#).

About this task

- i** **NOTE:** This procedure applies only to computers shipped with a M.2 2280 solid-state drive installed.
- i** **NOTE:** The M.2 card that is installed on your system depends on the configuration ordered. Supported card configurations on the M.2 card slot are:
- M.2 2230 solid-state drive
 - M.2 2280 solid-state drive

The following images indicate the location of the M.2 2280 solid-state drive and provide a visual representation of the removal procedure.



1x
M2x2

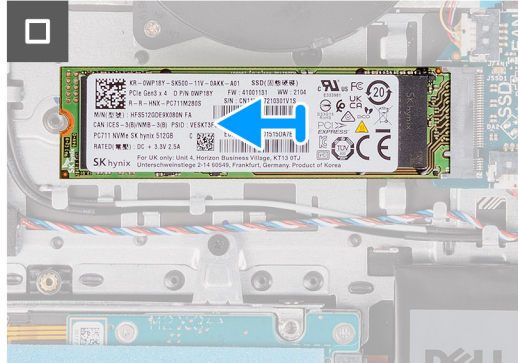
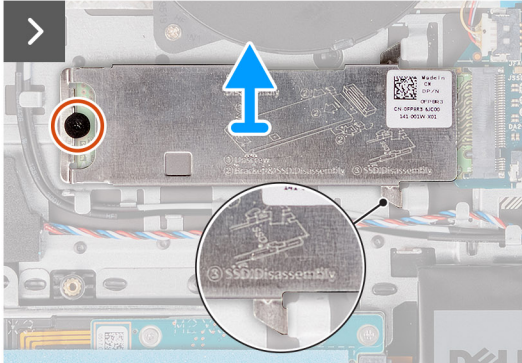

Steps

1. Remove the screw (M2x2) that secures the M.2 2280 solid-state drive thermal plate to the palm-rest and keyboard assembly.
2. Slide and remove the M.2 2280 solid-state drive thermal plate from the palm-rest and keyboard assembly.
3. Slide and remove the M.2 2280 solid-state drive from the M.2 card slot on the system board.

Installing the M.2 2280 solid-state drive

Prerequisites

If you are replacing a component, remove the existing component before performing the installation procedure.

About this task

The following images indicate the location of the M.2 2280 solid-state drive and provide a visual representation of the installation procedure.



1x
M2x2

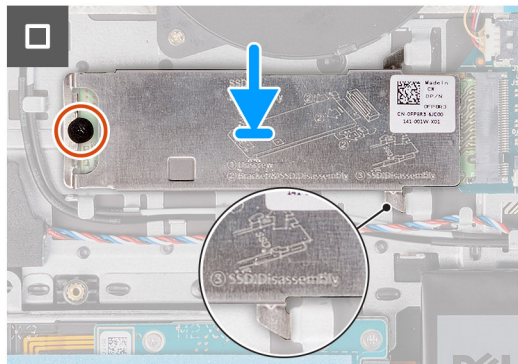
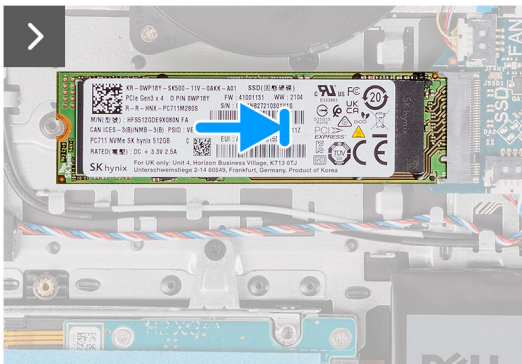

Steps

1. Align the notch on the M.2 2280 solid-state drive with the tab on the M.2 card slot on the system board.
2. Slide the M.2 2280 solid-state drive in the M.2 card slot on the system board.
3. Place the M.2 2280 solid-state drive thermal plate on the M.2 2280 solid-state drive.
NOTE: When installing the M.2 2280 solid-state drive thermal plate on the computer, tuck the tabs on the M.2 2280 solid-state drive thermal plate under the hooks on the palm-rest and keyboard assembly.
4. Align the screw hole on the M.2 2280 solid-state drive thermal plate with the screw hole on the palm-rest and keyboard assembly.
5. Replace the screw (M2x2) to secure the M.2 2280 solid-state drive thermal plate to the palm-rest and keyboard assembly.

Next steps

1. Install the [base cover](#).
2. Follow the procedure in [After working inside your computer](#).

Wireless card

Removing the wireless card

Prerequisites

1. Follow the procedure in [Before working inside your computer](#).
2. Remove the [base cover](#).

About this task

The following images indicate the location of the wireless card and provide a visual representation of the removal procedure.



1x
M2x3.5

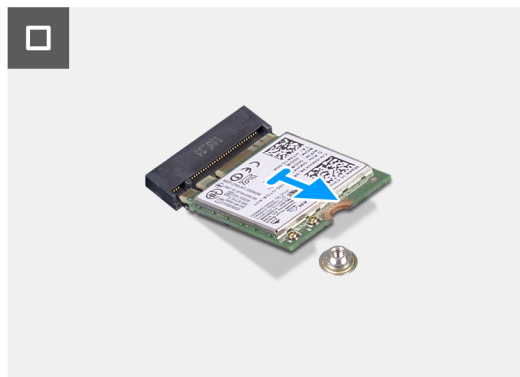
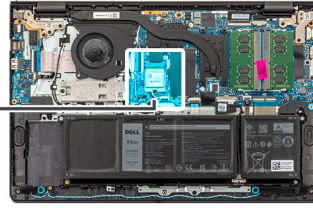

Steps

1. Remove the screw (M2x3.5) that secures the wireless-card bracket to the system board.
2. Lift the wireless-card bracket off the wireless card.
3. Disconnect the wireless-antenna cables from the connectors on the wireless card.
4. Slide and remove the wireless card from the wireless-card slot on the system board.

Installing the wireless card

Prerequisites

If you are replacing a component, remove the existing component before performing the installation procedure.

About this task

The following images indicate the location of the wireless card and provide a visual representation of the installation procedure.



1x
M2x3.5

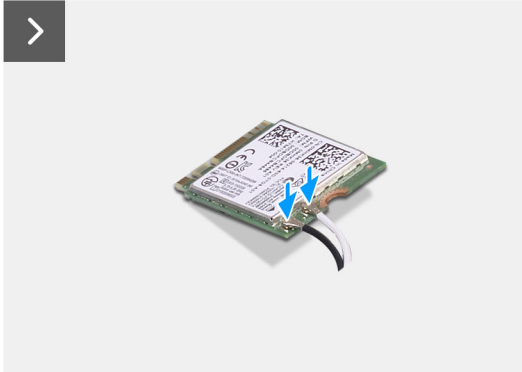
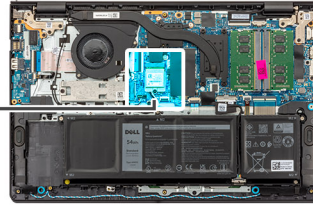

Steps

1. At an angle, slide the wireless card into the wireless-card slot on the system board.
2. Connect the wireless-antenna cables to the wireless card.

The following table provides the antenna-cable color scheme for the wireless card supported by your computer.

Table 29. Antenna-cable color scheme

Connectors on the wireless card	Antenna-cable color	Silkscreen marking	
Main	White	MAIN	△ (white triangle)
Auxiliary	Black	AUX	▲ (black triangle)

3. Place the wireless-card bracket on the wireless card.
4. Align the screw hole on the wireless-card bracket with the screw hole on the system board.
5. Replace the screw (M2x3.5) to secure the wireless-card bracket and the wireless card to the system board.

Next steps

1. Install the [base cover](#).
2. Follow the procedure in [After working inside your computer](#).

Speakers

Removing the speakers

Prerequisites

1. Follow the procedure in [Before working inside your computer](#).
2. Remove the [base cover](#).

About this task

The following image indicates the location of the speakers and provides a visual representation of the removal procedure.

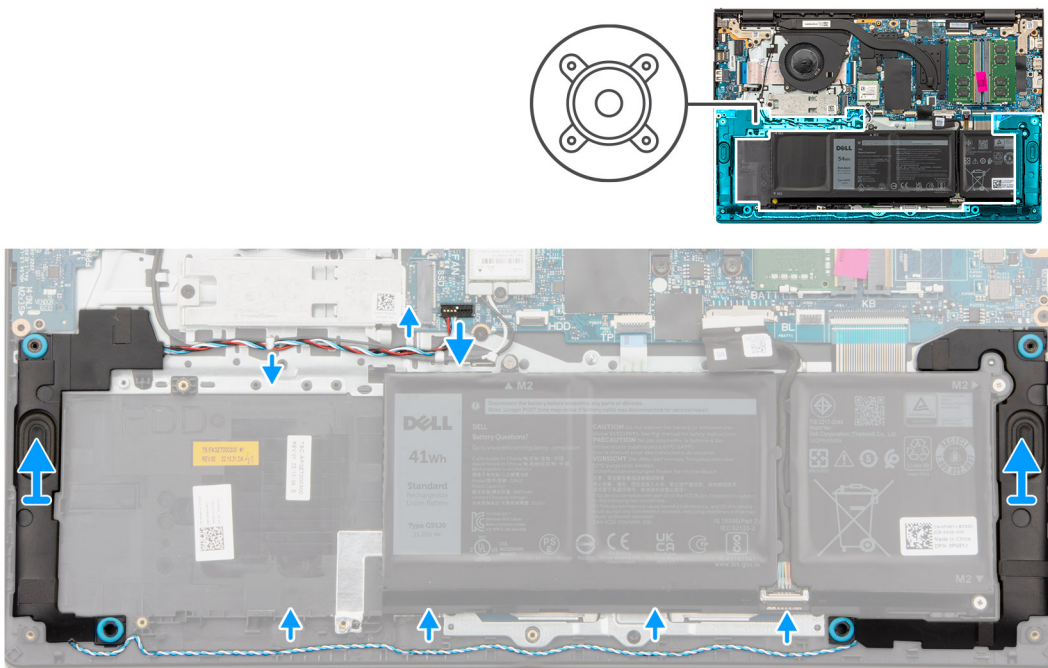

Steps

1. Disconnect the speaker cable from the connector on the system board.

i **NOTE:** To disconnect the speaker cable featuring an eight-pin connector from the system board, pry up the bottom side of the cable connector's head first and then pull it away from the connector.

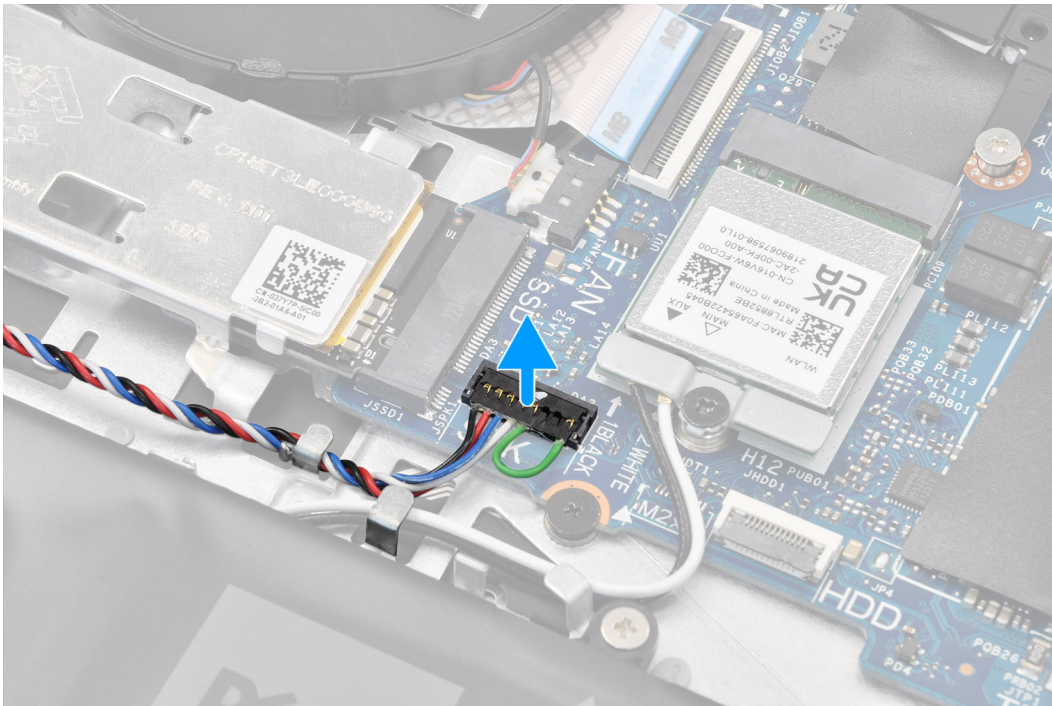

2. Unroute and remove the speaker cable from the routing guides on palm-rest and keyboard assembly.
3. Lift the speakers, along with the cable, off the palm-rest and keyboard assembly.

Installing the speakers

Prerequisites

If you are replacing a component, remove the existing component before performing the installation procedure.

About this task

NOTE: If the rubber grommets are pushed out when removing the speakers, push them back in before replacing the speakers.

The following image indicates the location of the speakers and provides a visual representation of the installation procedure.

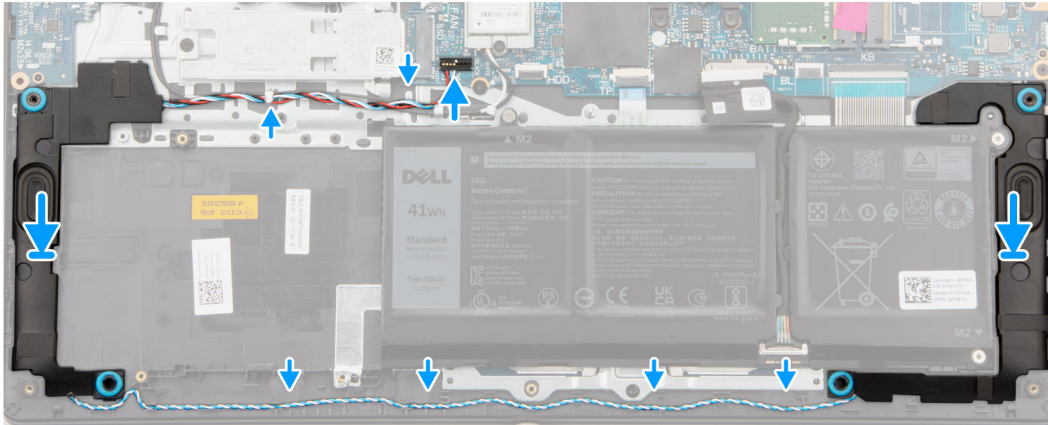
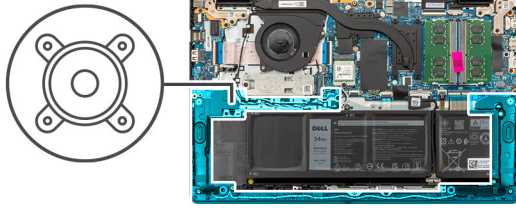

Steps

1. Using the alignment posts and rubber grommets, place the speakers in the slots on the palm-rest and keyboard assembly.
 - i NOTE:** Ensure that the alignment posts are threaded through the rubber grommets on the speakers.
2. Route the speaker cable along the bottom side of the palm-rest and keyboard assembly, over the wireless-antenna cables. Then secure the speaker cable into the routing guides on the palm-rest and keyboard assembly.
 - i NOTE:** The speaker cable must be routed through the routing guides to avoid damaging the speaker cable when installing the base cover.

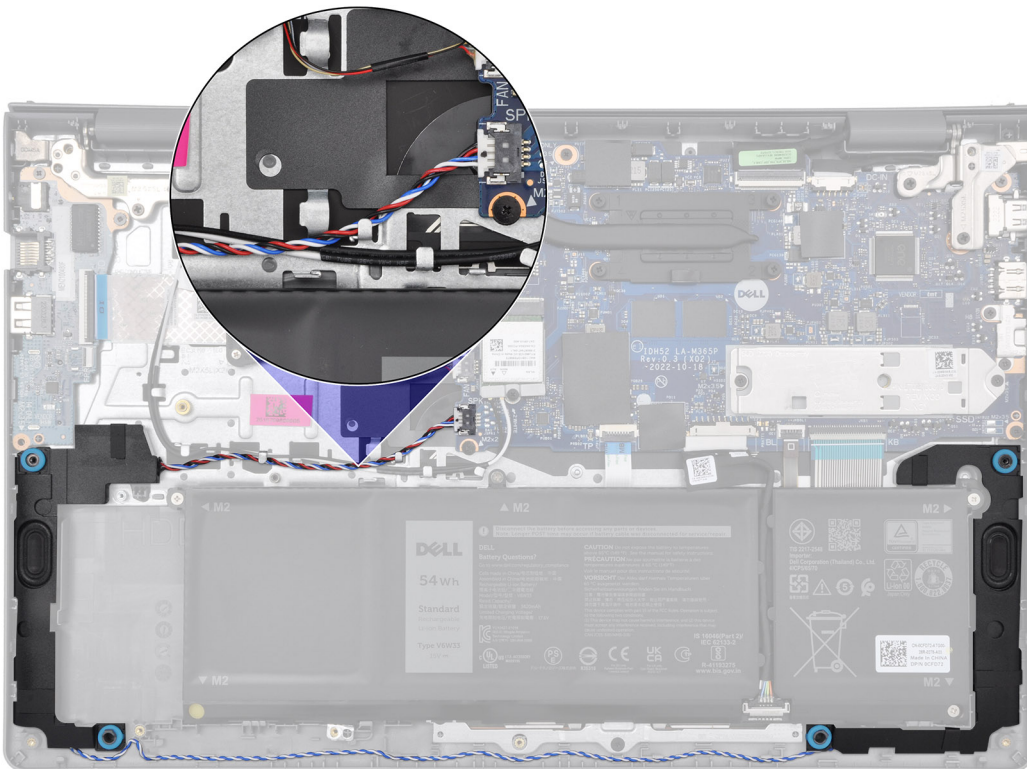

3. Connect the speaker cable to the connector on the system board.

Next steps

1. Install the [base cover](#).
2. Follow the procedure in [After working inside your computer](#).

Fan

Removing the fan

Prerequisites

1. Follow the procedure in [Before working inside your computer](#).
2. Remove the [base cover](#).

About this task

The following image indicates the location of the fan and provides a visual representation of the removal procedure.

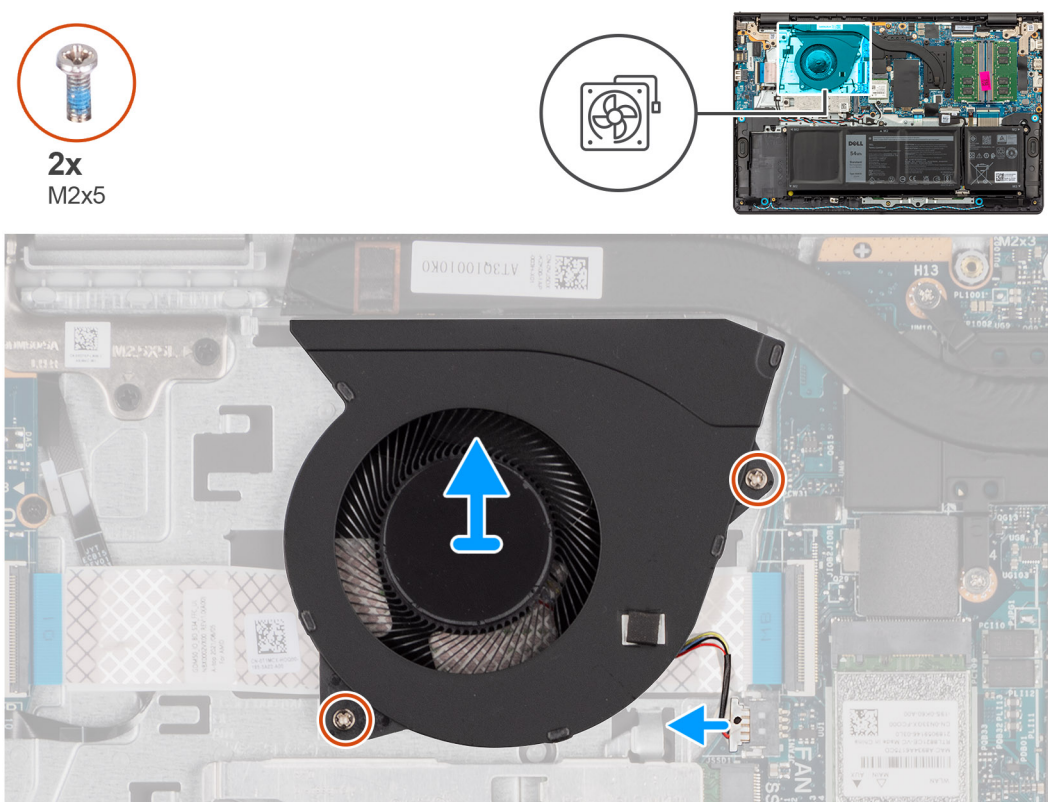

Steps

1. Disconnect the fan cable from the connector on the system board.
2. Remove the two screws (M2x5) that secure the fan to the palm-rest and keyboard assembly.
3. Lift the fan off the palm-rest and keyboard assembly.

Installing the fan

Prerequisites

If you are replacing a component, remove the existing component before performing the installation procedure.

About this task

The following image indicates the location of the fan and provides a visual representation of the installation procedure.



2x
M2x5

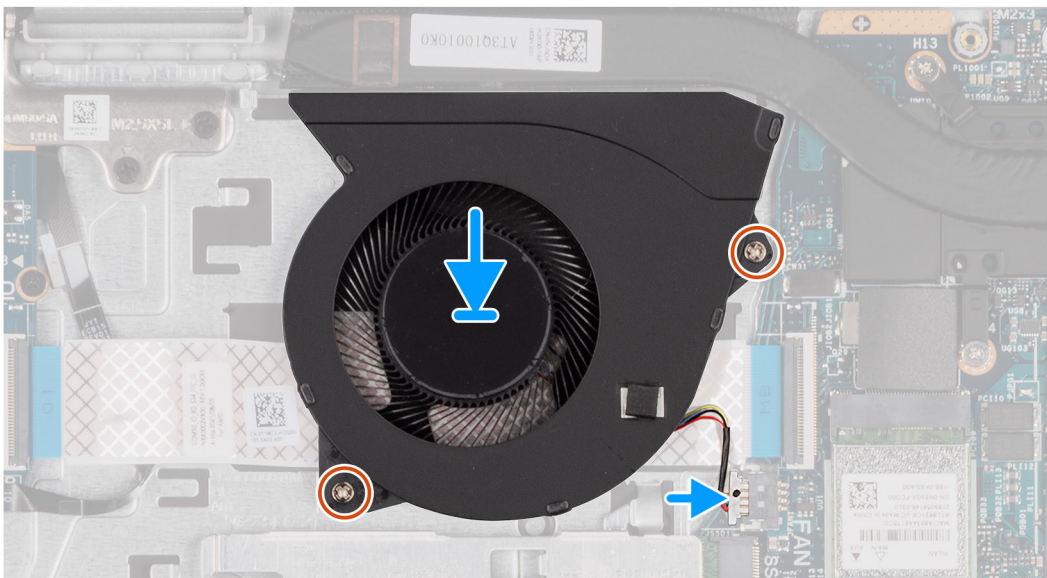
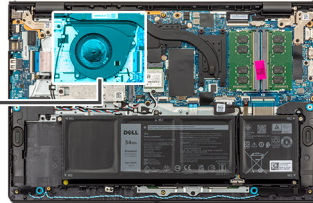
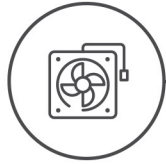

Steps

1. Place the fan in the slot on the palm-rest and keyboard assembly.
2. Align the screw holes on the fan to the screw holes on the palm-rest and keyboard assembly.
3. Replace the two screws (M2x5) to secure the fan to the palm-rest and keyboard assembly.
4. Connect the fan cable to the connector on the system board.

Next steps

1. Install the [base cover](#).
2. Follow the procedure in [After working inside your computer](#).

Removing and installing Field Replaceable Units (FRUs)

The replaceable components in this chapter are Field Replaceable Units (FRUs).

CAUTION: The information in this section is intended for authorized service technicians only.

CAUTION: To avoid any potential damage to the component or loss of data, ensure that an authorized service technician replaces the Field Replaceable Units (FRUs).

CAUTION: Dell Technologies recommends that this set of repairs, if needed, to be conducted by trained technical repair specialists.

CAUTION: As a reminder, your warranty does not cover damages that may occur during the courses of FRU repairs that are not authorized by Dell Technologies.

NOTE: The images in this document may differ from your computer depending on the configuration you ordered.

Battery

Lithium-ion battery precautions

CAUTION:

- Exercise caution when handling Lithium-ion batteries.
- Discharge the battery completely before removing it. Disconnect the AC power adapter from the system and operate the computer solely on battery power—the battery is fully discharged when the computer no longer turns on when the power button is pressed.
- Do not crush, drop, mutilate, or penetrate the battery with foreign objects.
- Do not expose the battery to high temperatures, or disassemble battery packs and cells.
- Do not apply pressure to the surface of the battery.
- Do not bend the battery.
- Do not use tools of any kind to pry on or against the battery.
- Ensure any screws during the servicing of this product are not lost or misplaced, to prevent accidental puncture or damage to the battery and other system components.
- If the battery gets stuck inside your computer as a result of swelling, do not try to release it as puncturing, bending, or crushing a lithium-ion battery can be dangerous. In such an instance, contact Dell technical support for assistance. See www.dell.com/contactdell.
- Always purchase genuine batteries from www.dell.com or authorized Dell partners and resellers.
- Swollen batteries should not be used and should be replaced and disposed properly. For guidelines on how to handle and replace swollen Lithium-ion batteries, see [Handling swollen Lithium-ion batteries](#).

Removing the 3-cell battery

CAUTION: The information in this section is intended for authorized service technicians only.

Prerequisites

1. Follow the procedure in [Before working inside your computer.](#)
2. Remove the [base cover.](#)

About this task

The following image indicates the location of the 3-cell battery and provides a visual representation of the removal procedure.

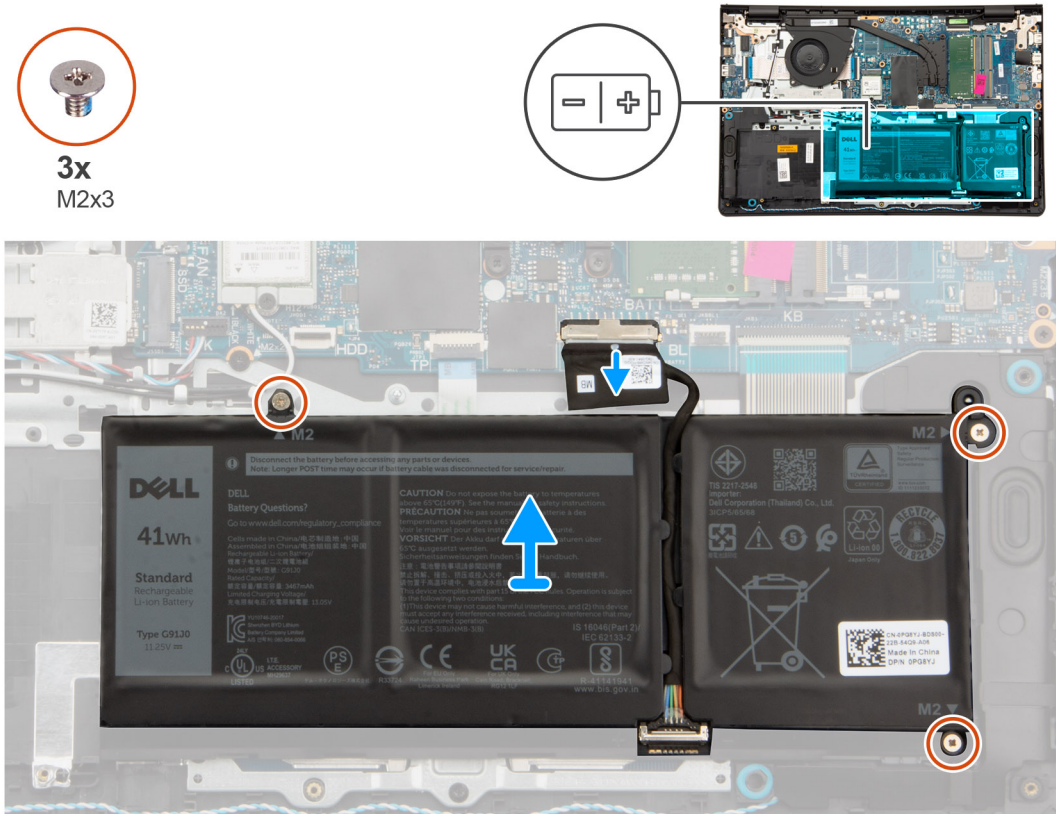

Steps

1. Using the pull tab, disconnect the battery cable from the connector on the system board.
 2. Remove the three screws (M2x3) that secure the 3-cell battery to the palm-rest and keyboard assembly.
 3. Lift the 3-cell battery, along with the battery cable, off the palm-rest and keyboard assembly.
- NOTE:** Computers shipped with an aluminum chassis have two RF metal wall brackets installed on the left and right sides of the palm-rest and keyboard assembly. The right bracket is secured by the battery with no screw, tape, or adhesives otherwise securing the bracket in place. Technicians should take note of whether the bracket has fallen out of the computer during subsequent removal procedures.

Installing the 3-cell battery

CAUTION: The information in this section is intended for authorized service technicians only.

Prerequisites

If you are replacing a component, remove the existing component before performing the installation procedure.

About this task

The following image indicates the location of the 3-cell battery and provides a visual representation of the installation procedure.

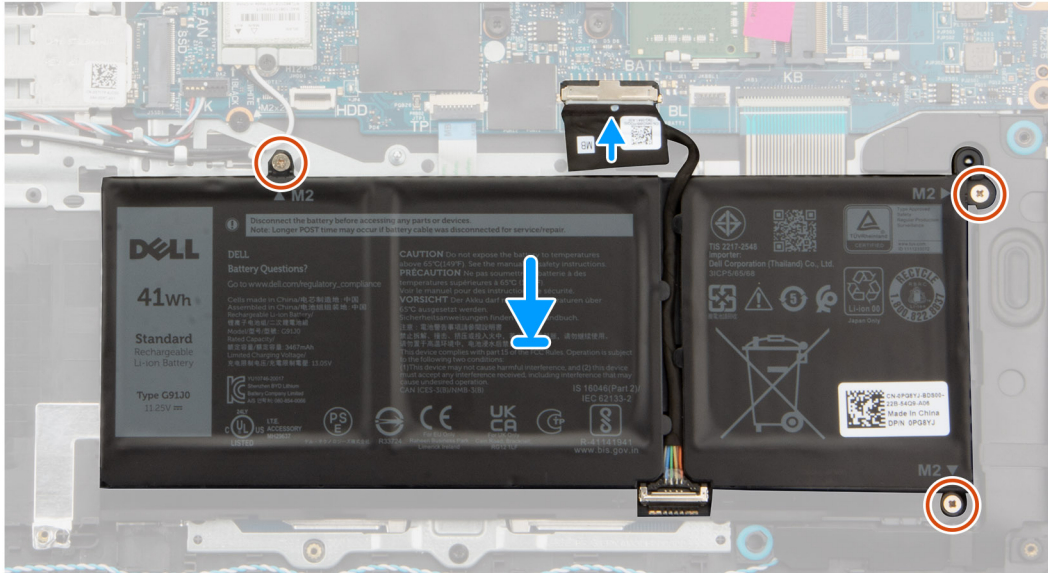
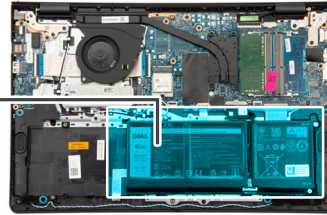
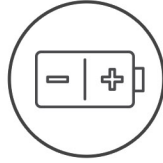

Steps

1. Place the 3-cell battery, along with the battery cable, in the slot on the palm-rest and keyboard assembly.
2. Align the screw holes on the 3-cell battery to the screw holes on the palm-rest and keyboard assembly.
3. Replace the three screws (M2x3) to secure the 3-cell battery to the palm-rest and keyboard assembly.
4. Connect the battery cable to the connector on the system board.

Next steps

1. Install the [base cover](#).
2. Follow the procedure in [After working inside your computer](#).

Removing the 4-cell battery

CAUTION: The information in this section is intended for authorized service technicians only.

Prerequisites

1. Follow the procedure in [Before working inside your computer](#).
2. Remove the [base cover](#).

About this task

The following image indicates the location of the 4-cell battery and provides a visual representation of the removal procedure.



4x
M2x3

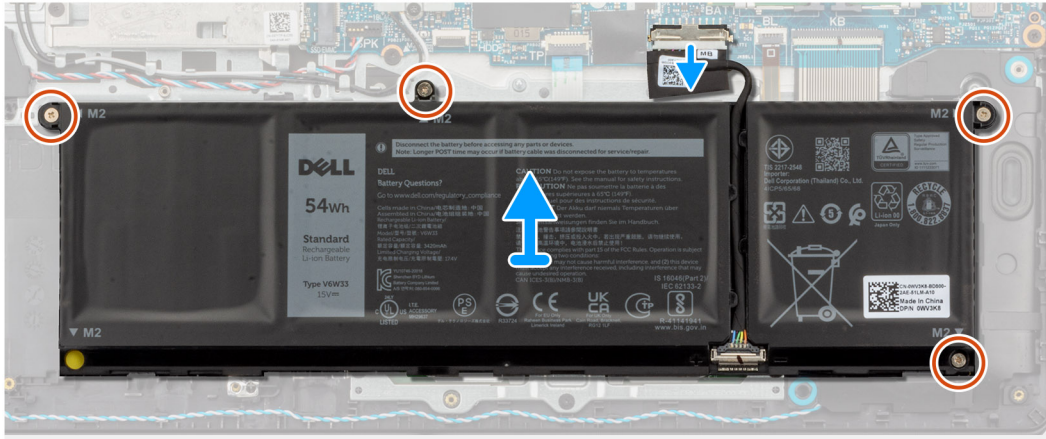
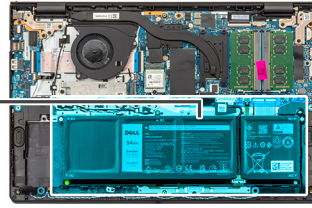
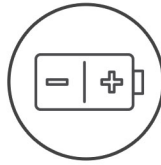

Steps

1. Using the pull tab, disconnect the battery cable from the connector on the system board.
2. Remove the four screws (M2x3) that secure the 4-cell battery to the palm-rest and keyboard assembly.
3. Lift the 4-cell battery, along with the battery cable, off the palm-rest and keyboard assembly.
 - i** **NOTE:** Computers shipped with an aluminum chassis have two RF metal wall brackets installed on the left and right sides of the palm-rest and keyboard assembly. The right bracket is secured by the battery with no screw, tape, or adhesives otherwise securing the bracket in place. As a result, technicians should take note of whether the bracket has fallen out of the computer during subsequent removal procedures.
4. Carefully push and remove the battery rubber stopper out of the bottom-left screw hole of the 4-cell battery.
 - i** **NOTE:** When replacing the 4-cell battery, use a plastic scribe to push upward through the bottom-left screw hole to remove the battery rubber stopper and transfer it to the new replacement 4-cell battery.

Installing the 4-cell battery

⚠ CAUTION: The information in this section is intended for authorized service technicians only.

Prerequisites

If you are replacing a component, remove the existing component before performing the installation procedure.

About this task

The following image indicates the location of the 4-cell battery and provides a visual representation of the installation procedure.



4x
M2x3

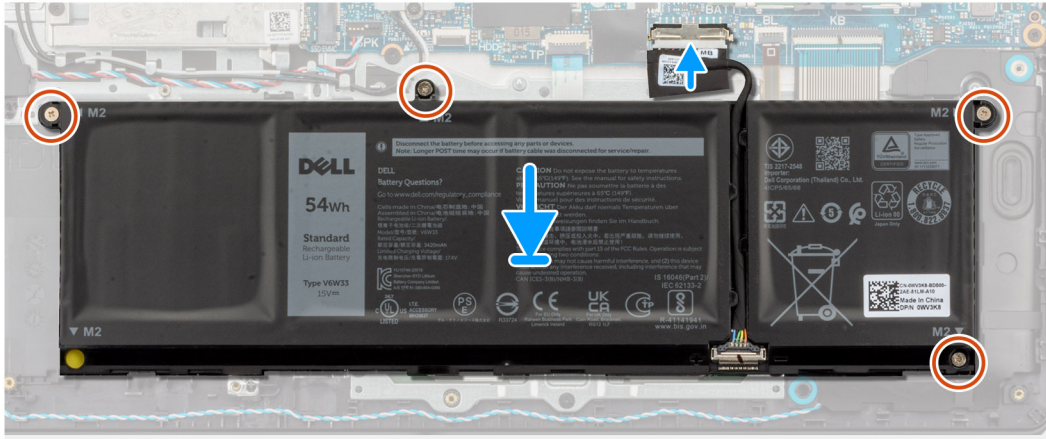
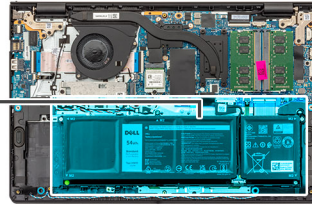
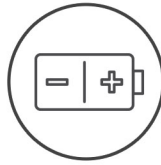

Steps

1. Carefully push and insert the battery rubber stopper into the bottom-left screw hole of the 4-cell battery.
 - NOTE:** When replacing the 4-cell battery, use a plastic scribe to push downward into the bottom-left screw hole to insert the battery rubber stopper into the slot on the new replacement 4-cell battery.
2. Place the 4-cell battery, along with the battery cable, in the slot on the palm-rest and keyboard assembly.
3. Align the screw holes on the 4-cell battery to the screw holes on the palm-rest and keyboard assembly.
4. Replace the four screws (M2x3) to secure the 4-cell battery to the palm-rest and keyboard assembly.
5. Connect the battery cable to the connector on the system board.

Next steps

1. Install the [base cover](#).
2. Follow the procedure in [After working inside your computer](#).

Disconnecting the battery cable

CAUTION: The information in this section is intended for authorized service technicians only.

Prerequisites

1. Follow the procedure in [Before working inside your computer](#).
2. Remove the [base cover](#).
3. Remove the [3-cell battery](#) or the [4-cell battery](#), whichever applicable.

About this task

The following image indicates the location of the battery cable and provides a visual representation of the removal procedure.

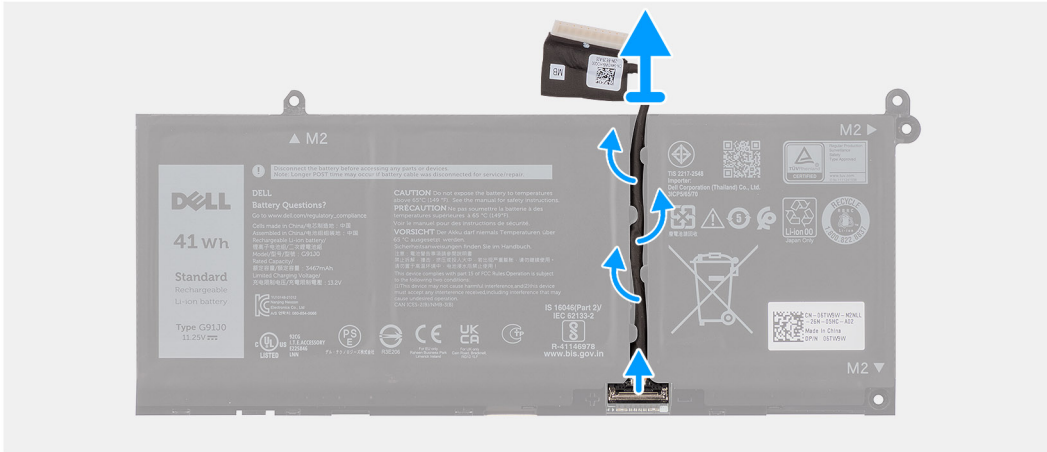

Steps

1. Unroute the battery cable from the routing guides on the battery.
2. Open the latch and disconnect the battery cable from the connector on the battery.

i **NOTE:** To disconnect the battery cable, first push the latch downward to release the connector, and then pull the connector upward to disconnect it from the battery.

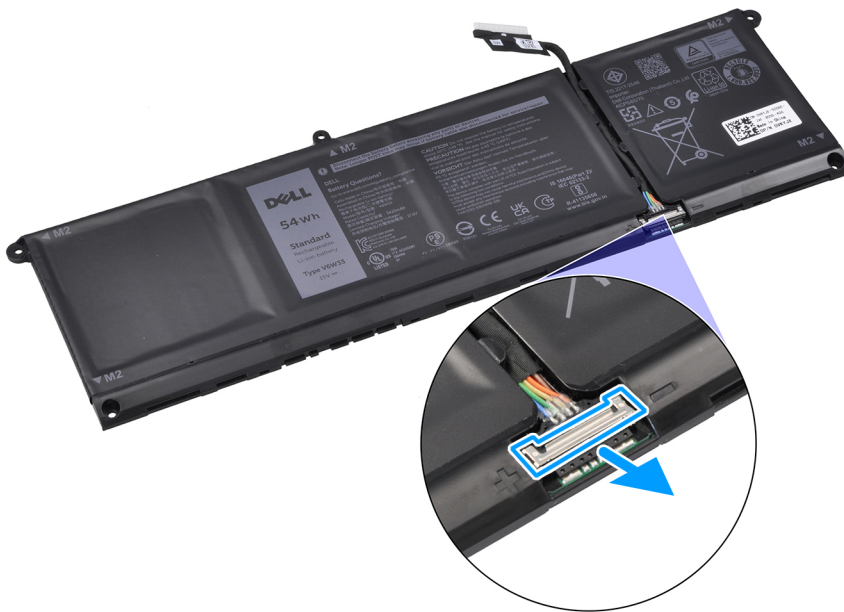

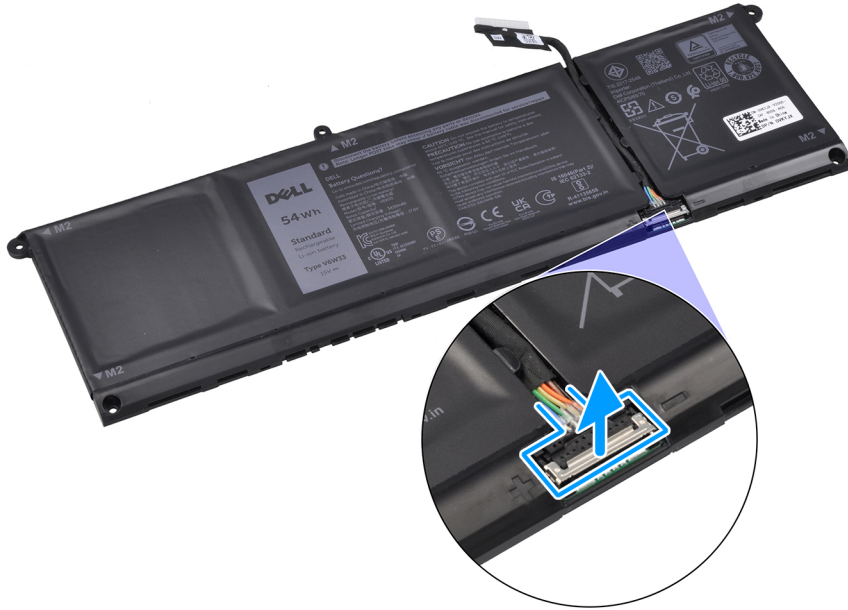

CAUTION: DO NOT pull the battery cable to disconnect it from the battery. This may damage the battery or the battery cable.

Connecting the battery cable

CAUTION: The information in this section is intended for authorized service technicians only.

Prerequisites

If you are replacing a component, remove the existing component before performing the installation procedure.

About this task

The following image indicates the location of the battery cable and provides a visual representation of the installation procedure.

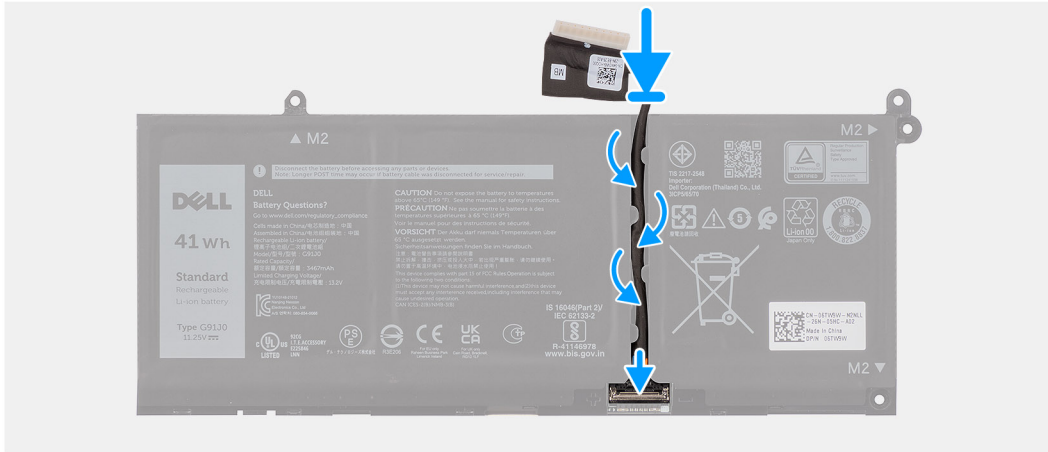

Steps

1. Connect the battery cable to the connector on the battery and close the latch.
2. Route the battery cable through the routing guides on the battery.

Next steps

1. Install the [3-cell battery](#) or the [4-cell battery](#), whichever applicable.
2. Install the [base cover](#).
3. Follow the procedure in [After working inside your computer](#).

Heat sink

Removing the heat sink - integrated

CAUTION: The information in this section is intended for authorized service technicians only.

Prerequisites

1. Follow the procedure in [Before working inside your computer](#).
2. Remove the [base cover](#).

About this task

NOTE: The integrated heat sink may become hot during normal operation. Allow sufficient time for the integrated heat sink to cool before you touch it.

NOTE: For maximum cooling of the processor, do not touch the heat transfer areas on the integrated heat sink. The oils in your skin can reduce the heat transfer capability of the thermal grease.

The following image indicates the location of the integrated heat sink and provides a visual representation of the removal procedure.

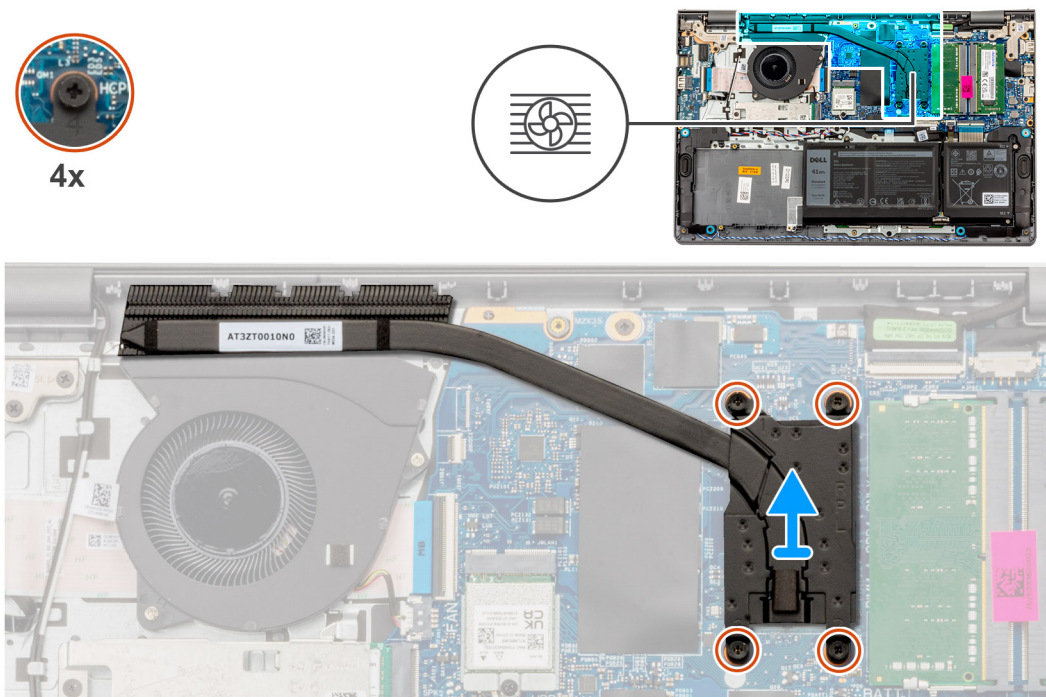

Steps

1. Loosen the four captive screws that secure the heat sink to the system board.
i **NOTE:** Loosen the four captive screws in the reverse sequential order mentioned on the heat sink [4 > 3 > 2 > 1].
2. Lift the heat sink off the system board.

Installing the heat sink

CAUTION: The information in this section is intended for authorized service technicians only.

Prerequisites

If you are replacing a component, remove the existing component before performing the installation procedure.

About this task

i **NOTE:** If either the system board or the integrated heat sink is replaced, use the thermal grease provided in the kit to ensure that thermal conductivity is achieved.

The following image indicates the location of the integrated heat sink and provides a visual representation of the installation procedure.

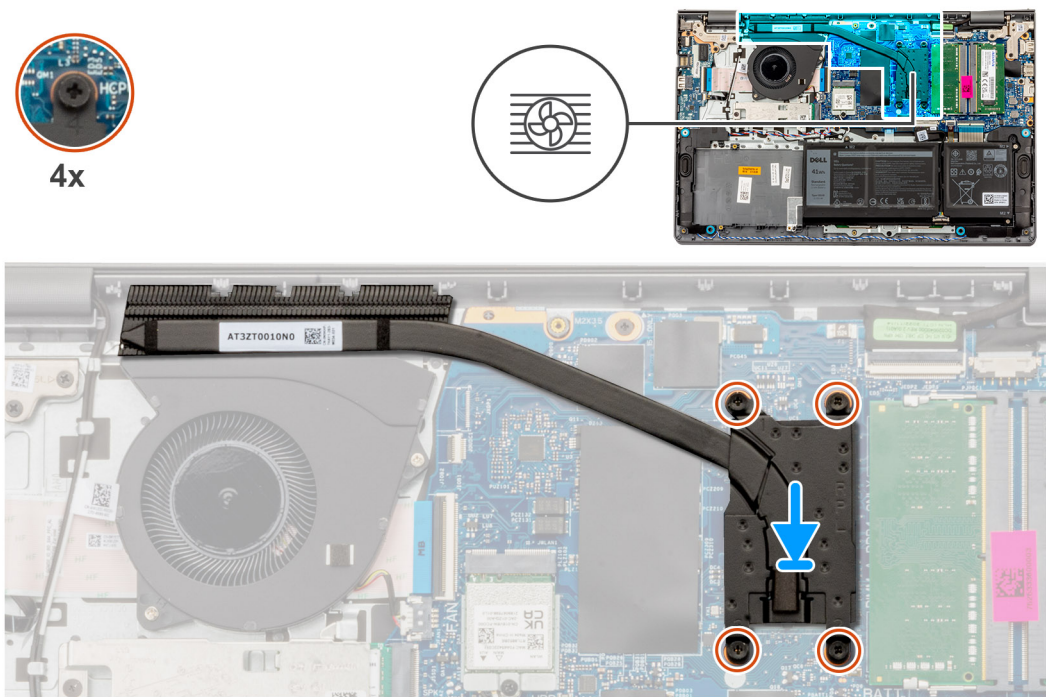

Steps

1. Place the heat sink in the slot on the system board.
2. Align the screw holes on the heat sink to the screw holes on the system board.
3. Tighten the four captive screws to secure the heat sink to the system board.

i **NOTE:** Tighten the four captive screws in the sequential order mentioned on the heat sink [1 > 2 > 3 > 4].

Next steps

1. Install the [base cover](#).
2. Follow the procedure in [After working inside your computer](#).

Removing the heat sink - discrete

Prerequisites

1. Follow the procedure in [Before working inside your computer](#).
2. Remove the [base cover](#).

About this task

i **NOTE:** The discrete heat sink may become hot during normal operation. Allow sufficient time for the discrete heat sink to cool before you touch it.

i **NOTE:** For maximum cooling of the processor, do not touch the heat transfer areas on the discrete heat sink. The oils in your skin can reduce the heat transfer capability of the thermal grease.

The following image indicates the location of the discrete heat sink and provides a visual representation of the removal procedure.

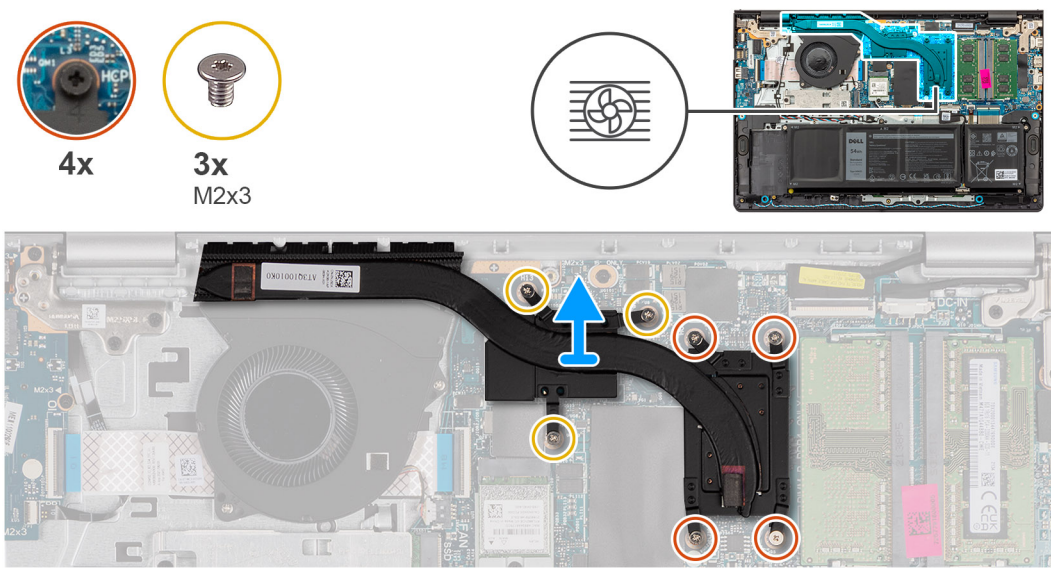

Steps

1. Remove the three screws (M2x3) and loosen the four captive screws that secure the discrete heat sink to the system board.
i **NOTE:** Loosen the four captive screws in the reverse sequential order mentioned on the discrete heat sink [4 > 3 > 2 > 1].
2. Lift and remove the discrete heat sink from the system board.

Installing the heat sink - discrete

Prerequisites

If you are replacing a component, remove the existing component before performing the installation procedure.

About this task

i **NOTE:** If either the system board or the discrete heat sink is replaced, use the thermal grease provided in the kit to ensure that thermal conductivity is achieved.

The following image indicates the location of the discrete heat sink and provides a visual representation of the installation procedure.

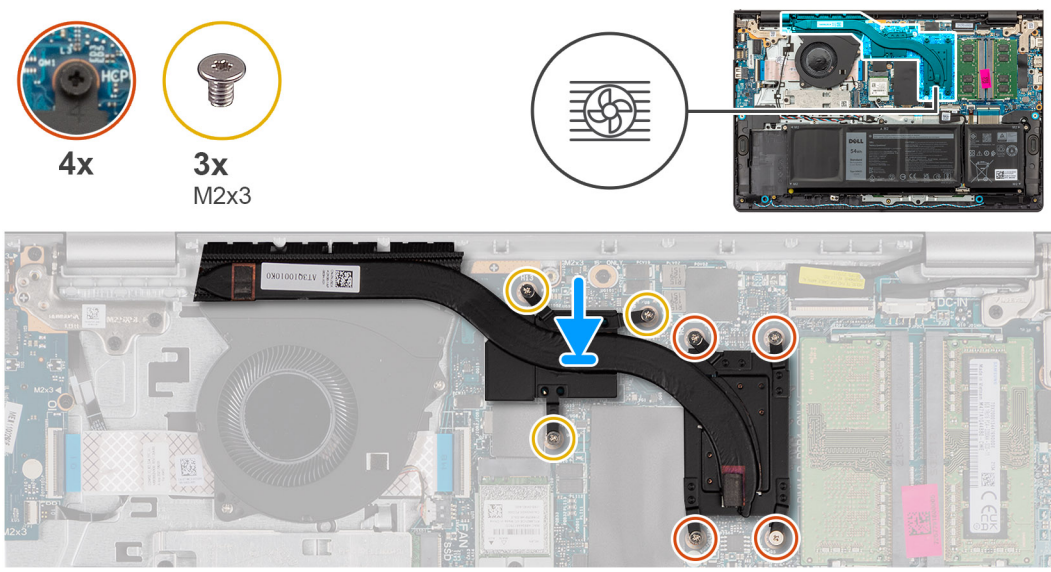

Steps

1. Place the discrete heat sink on the system board.
2. Align the screw holes on the discrete heat sink to the screw holes on the system board.
3. Replace the three screws (M2x3) and tighten the four captive screws to secure the discrete heat sink to the system board.

NOTE: Tighten the four captive screws in the sequential order mentioned on the discrete heat sink [1 > 2 > 3 > 4].

Next steps

1. Install the [base cover](#).
2. Follow the procedure in [After working inside your computer](#).

Touchpad

Removing the touchpad

CAUTION: The information in this section is intended for authorized service technicians only.

Prerequisites

1. Follow the procedure in [Before working inside your computer](#).
2. Remove the [base cover](#).
3. Remove the [3-cell battery](#) or the [4-cell battery](#), whichever applicable.

About this task

The following images indicate the location of the touchpad and provide a visual representation of the removal procedure.



5x
M2x2

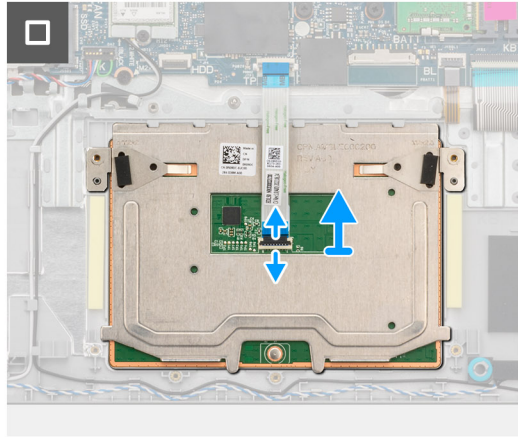
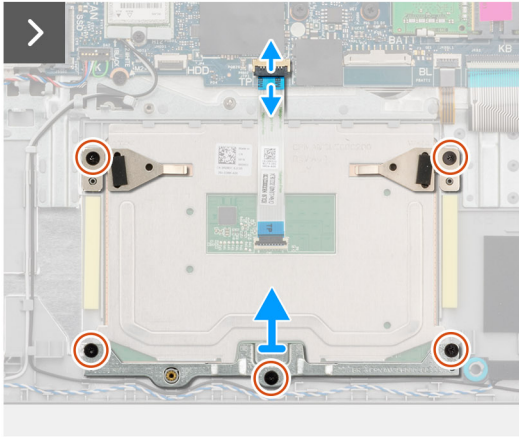
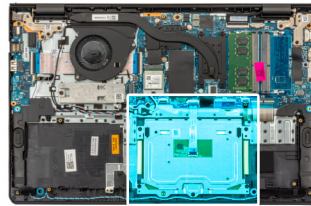

Steps

1. Open the latch and disconnect the touchpad FFC from the connector on the system board.
2. Remove the three screws (M2x2) that secure the touchpad bracket to the palm-rest and keyboard assembly.
3. Lift the touchpad bracket off the touchpad assembly.
4. Remove the two screws (M2x2) that secure the touchpad to the palm-rest and keyboard assembly.
5. Lift the touchpad, along with the touchpad FFC, off the palm-rest and keyboard assembly.
6. Open the latch and disconnect the touchpad FFC from the connector on the touchpad.

Installing the touchpad

CAUTION: The information in this section is intended for authorized service technicians only.

Prerequisites

If you are replacing a component, remove the existing component before performing the installation procedure.

About this task

NOTE: Ensure that the touchpad is aligned with the guides available on the palm-rest and keyboard assembly, and the gap on either sides of the touchpad is equal.

The following images indicate the location of the touchpad and provide a visual representation of the installation procedure.



5x
M2x2

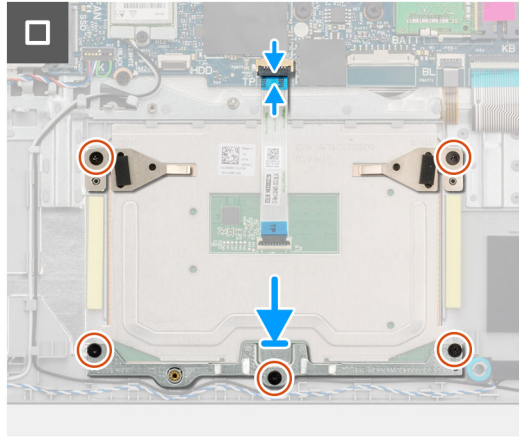
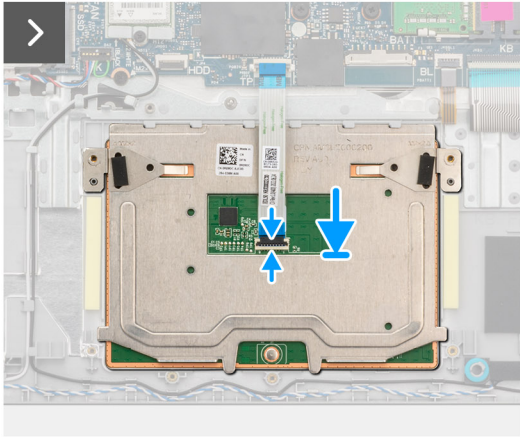
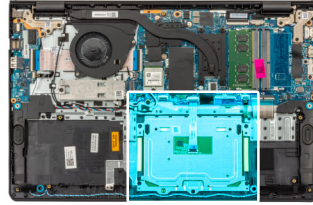

Steps

1. Connect the touchpad FFC to the connector on the touchpad and close the latch.
2. Align and place the touchpad, along with the touchpad FFC, in the slot on the palm-rest and keyboard assembly.
3. Replace the two screws (M2x2) to secure the touchpad to the palm-rest and keyboard assembly.
4. Place the touchpad bracket in the slot on the palm-rest and keyboard assembly.
5. Align the screw holes on the touchpad bracket to the screw holes on the palm-rest and keyboard assembly.
6. Replace the three screws (M2x2) to secure the touchpad bracket to the palm-rest and keyboard assembly.
7. Connect the touchpad FFC to the connector on the system board and close the latch.

Next steps

1. Install the [3-cell battery](#) or the [4-cell battery](#), whichever applicable.
2. Install the [base cover](#).
3. Follow the procedure in [After working inside your computer](#).

I/O daughter-board cable

Removing the I/O daughter-board cable

 **CAUTION:** The information in this section is intended for authorized service technicians only.

Prerequisites

1. Follow the procedure in [Before working inside your computer](#).
2. Remove the [base cover](#).
3. Remove the [fan](#).

About this task

The following image indicates the location of the I/O daughter-board cable and provides a visual representation of the removal procedure.

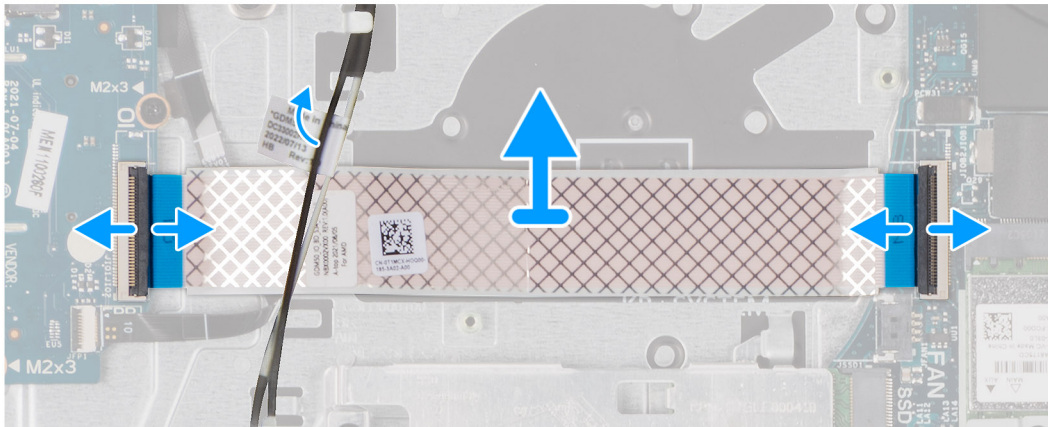
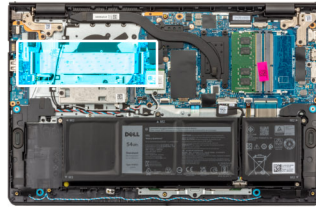

Steps

1. Open the latch and disconnect the I/O daughter-board cable from the connector on the system board.
2. Open the latch and disconnect the I/O daughter-board cable from the connector on the I/O daughter-board.
3. Remove the I/O daughter-board cable from the palm-rest and keyboard assembly.

NOTE: For computers shipped with a plastic chassis, carefully slide the I/O daughter-board cable underneath the wireless-antenna cables to remove the I/O daughter-board cable.

Installing the I/O daughter-board cable

CAUTION: The information in this section is intended for authorized service technicians only.

Prerequisites

If you are replacing a component, remove the existing component before performing the installation procedure.

About this task

The following image indicates the location of the I/O daughter-board cable and provides a visual representation of the installation procedure.

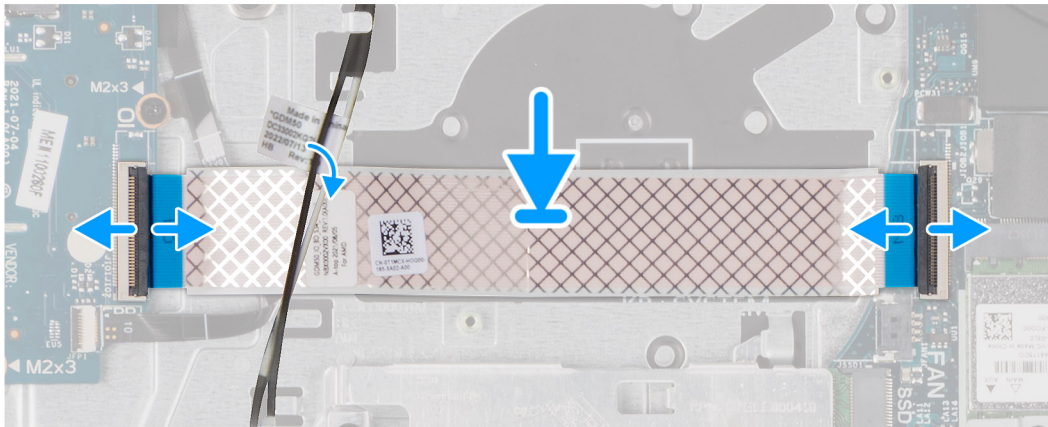
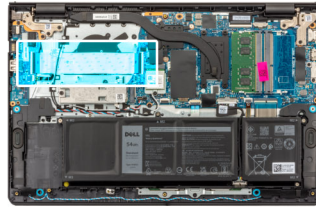

Steps

1. Place the I/O daughter-board cable on the palm-rest and keyboard assembly.
 - i** **NOTE:** For computers shipped with a plastic chassis, carefully slide the I/O daughter-board cable underneath the wireless-antenna cables to place the I/O daughter-board cable on the palm-rest and keyboard assembly.
2. Connect the I/O daughter-board cable to the connector on the I/O daughter-board and close the latch.
3. Connect the I/O daughter-board cable to the connector on the system board and close the latch.

Next steps

1. Install the [fan](#).
2. Install the [base cover](#).
3. Follow the procedure in [After working inside your computer](#).

I/O daughter-board

Removing the I/O daughter-board

⚠ CAUTION: The information in this section is intended for authorized service technicians only.

Prerequisites

1. Follow the procedure in [Before working inside your computer](#).
2. Remove the [base cover](#).

About this task

The following images indicate the location of the I/O daughter-board and provide a visual representation of the removal procedure.

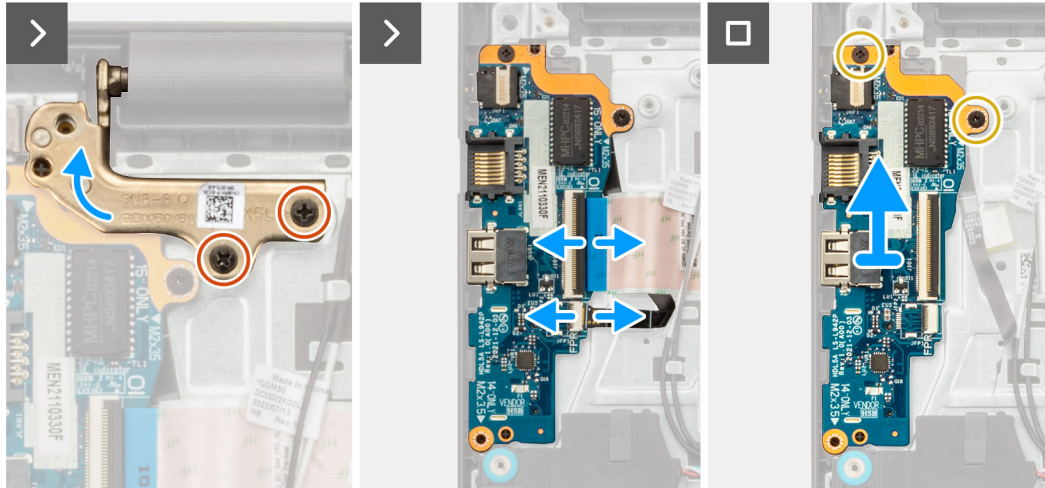
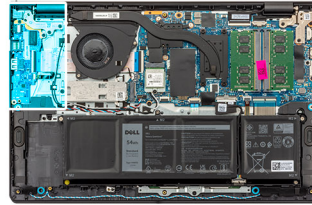

Steps

1. Remove the two screws (M2.5x5) that secure the left display hinge to the palm-rest and keyboard assembly.
2. Using a plastic scribe, lift the left display hinge away from the palm-rest and keyboard assembly to access the I/O daughter-board.
3. Open the latch and disconnect the I/O daughter-board cable from the connector on the I/O daughter-board.
4. Open the latch and disconnect the fingerprint reader cable from the I/O daughter-board.

NOTE: This step applies only to computers shipped with a fingerprint reader installed.
5. Remove the two screws (M2x3.5) that secure the I/O daughter-board to the palm-rest and keyboard assembly.
6. Carefully slide and remove the I/O daughter-board at angle, from the palm-rest and keyboard assembly, to clear the ports from the port openings.

Installing the I/O daughter-board

CAUTION: The information in this section is intended for authorized service technicians only.

Prerequisites

If you are replacing a component, remove the existing component before performing the installation procedure.

About this task

The following images indicate the location of the I/O daughter-board and provide a visual representation of the installation procedure.

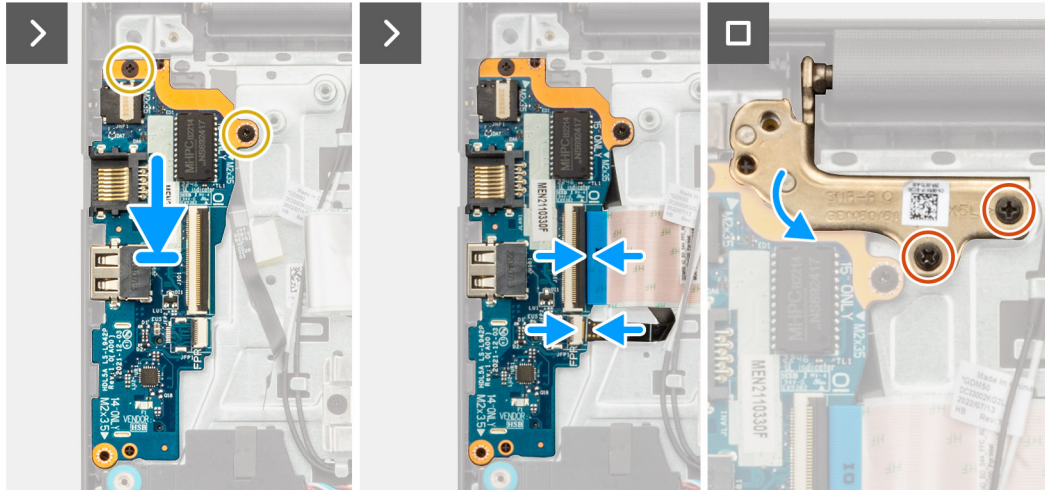
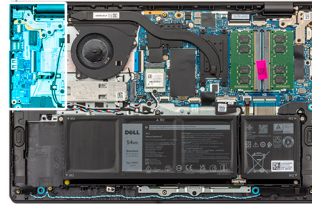

Steps

1. Align the ports on the I/O daughter-board to the port openings on the palm-rest and keyboard assembly.
2. Carefully slide and place the I/O daughter-board at an angle, on the palm-rest and keyboard assembly.
3. Align the screw holes on the I/O daughter-board to the screw holes on the palm-rest and keyboard assembly.
4. Replace the two screws (M2x3.5) to secure the I/O daughter-board to the palm-rest and keyboard assembly.
5. Connect the fingerprint reader cable to the connector on the I/O daughter-board and close the latch.

i **NOTE:** This step applies only to computers shipped with a fingerprint reader installed.
6. Connect the I/O daughter-board cable to the connector on the I/O daughter-board and close the latch.
7. Close the left display hinge downwards to align the screw holes on the left display hinge to the screw holes on the I/O daughter-board and the palm-rest and keyboard assembly.
8. Replace the two screws (M2.5x5) to secure the left display hinge to the I/O daughter-board and the palm-rest and keyboard assembly.

Next steps

1. Install the [base cover](#).
2. Follow the procedure in [After working inside your computer](#).

Power button

Removing the power button

⚠ CAUTION: The information in this section is intended for authorized service technicians only.

Prerequisites

1. Follow the procedure in [Before working inside your computer](#).
2. Remove the [base cover](#).
3. Remove the [I/O daughter-board](#).

About this task

The following image indicates the location of the power button and provides a visual representation of the removal procedure.



1x
M2x2

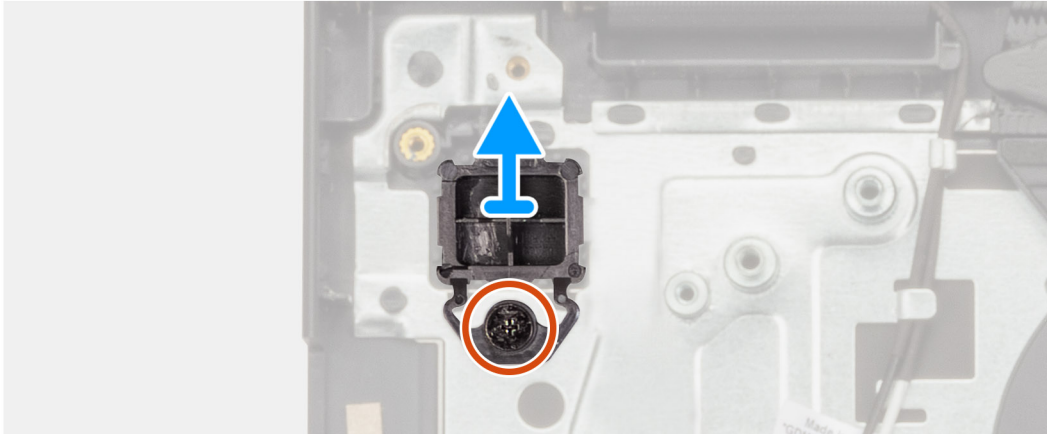
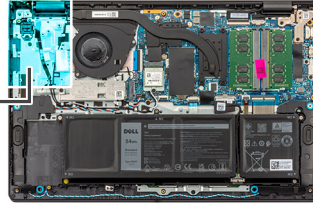

Steps

1. Remove the screw (M2x2) that secures the power button to the palm-rest and keyboard assembly.
2. Lift the power button off the palm-rest and keyboard assembly.

Installing the power button

CAUTION: The information in this section is intended for authorized service technicians only.

Prerequisites

If you are replacing a component, remove the existing component before performing the installation procedure.

About this task

The following image indicates the location of the power button and provides a visual representation of the installation procedure.



1x
M2x2

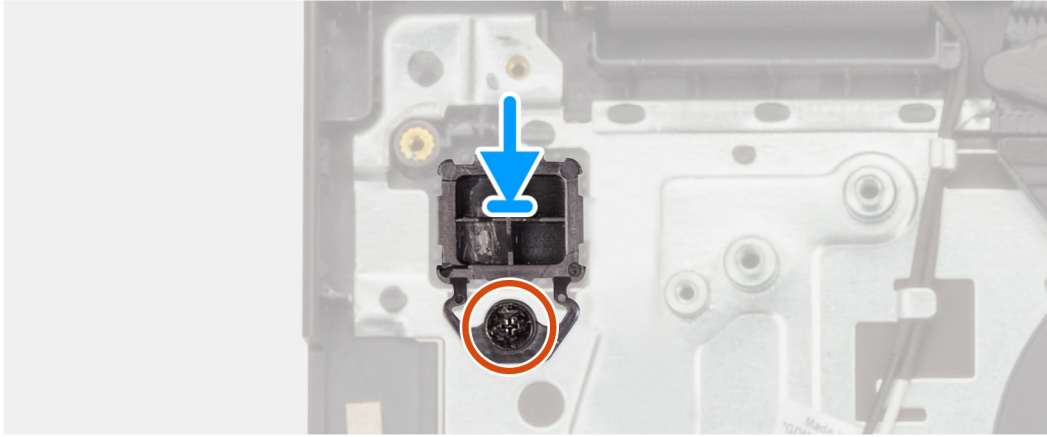
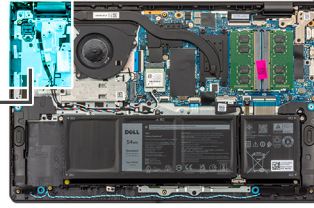

Steps

1. Place the power button in the slot on the palm-rest and keyboard assembly.
2. Align the screw hole on the power button to the screw hole on the palm-rest and keyboard assembly.
3. Replace the screw (M2x2) to secure the power button to the palm-rest and keyboard assembly.

Next steps

1. Install the [I/O daughter-board](#).
2. Install the [base cover](#).
3. Follow the procedure in [After working inside your computer](#).

Power button with optional fingerprint reader

Removing the power button with optional fingerprint reader

 **CAUTION:** The information in this section is intended for authorized service technicians only.

Prerequisites

1. Follow the procedure in [Before working inside your computer](#).
2. Remove the [base cover](#).
3. Remove the [I/O daughter-board](#).

About this task

 **NOTE:** This procedure applies only to computers shipped with a power button with optional fingerprint reader installed.

The following image indicates the location of the power button with optional fingerprint reader and provides a visual representation of the removal procedure.



1x
M2x2

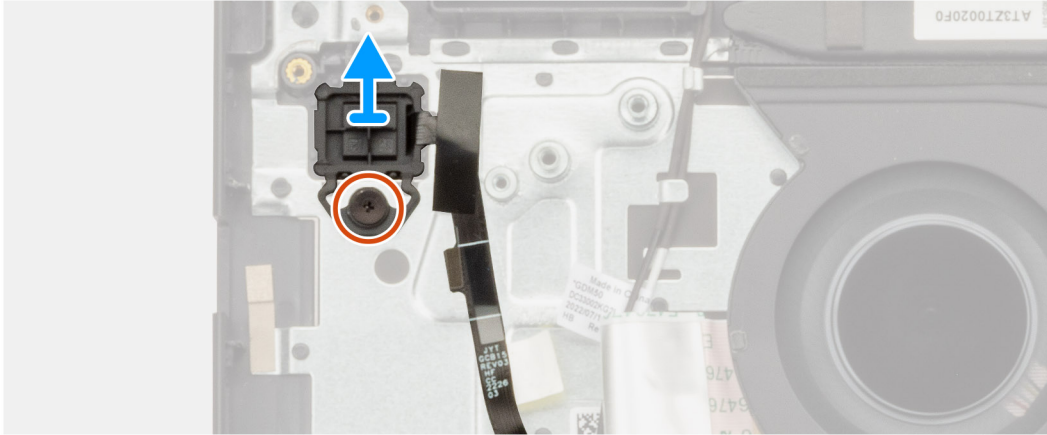
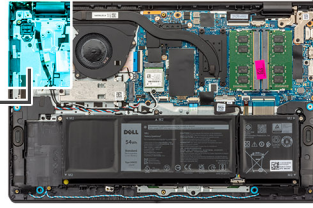

Steps

1. Peel back the tape that secures the optional fingerprint-reader flexible printed circuit to the palm-rest and keyboard assembly.
2. Remove the screw (M2x2) that secures the power button with optional fingerprint reader to the palm-rest and keyboard assembly.
3. Lift the power button with optional fingerprint reader off the slot on the palm-rest and keyboard assembly.

Installing the power button with optional fingerprint reader

CAUTION: The information in this section is intended for authorized service technicians only.

Prerequisites

If you are replacing a component, remove the existing component before performing the installation procedure.

About this task

NOTE: This procedure applies only to computers shipped with a power button with optional fingerprint reader installed.

The following image indicates the location of the power button with optional fingerprint reader and provides a visual representation of the installation procedure.



1x
M2x2

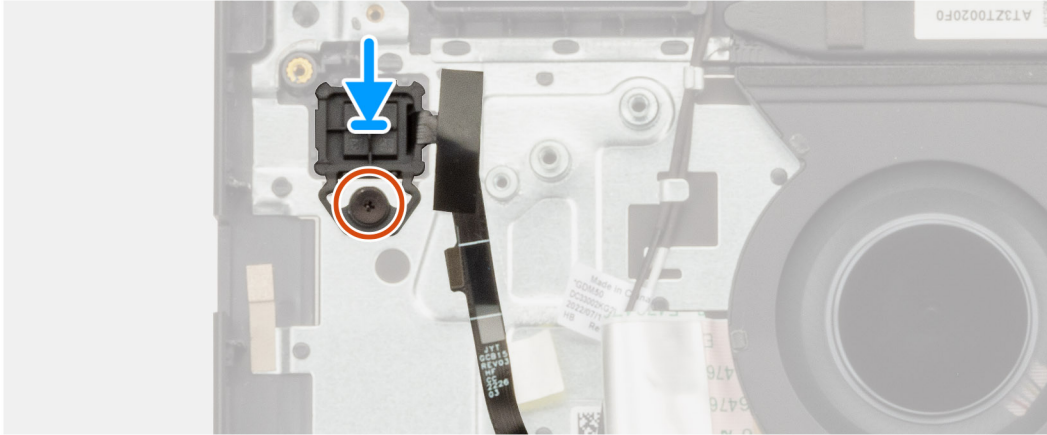
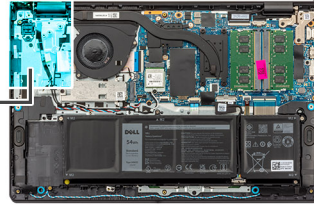

Steps

1. Place the power button with optional fingerprint reader in the slot on the palm-rest and keyboard assembly.
2. Align the screw hole on the power button with optional fingerprint reader to the screw hole on the palm-rest and keyboard assembly.
3. Replace the screw (M2x2) to secure the power button with optional fingerprint reader to the palm-rest and keyboard assembly.
4. Adhere the tape to secure the optional fingerprint-reader flexible printed circuit to the palm-rest and keyboard assembly.

Next steps

1. Install the [I/O daughter-board](#).
2. Install the [base cover](#).
3. Follow the procedure in [After working inside your computer](#).

Power-adapter port

Removing the power-adapter port

 **CAUTION:** The information in this section is intended for authorized service technicians only.

Prerequisites

1. Follow the procedure in [Before working inside your computer](#).
2. Remove the [base cover](#).

About this task

The following images indicate the location of the power-adapter port and provide a visual representation of the removal procedure.



2x
M2.5x5

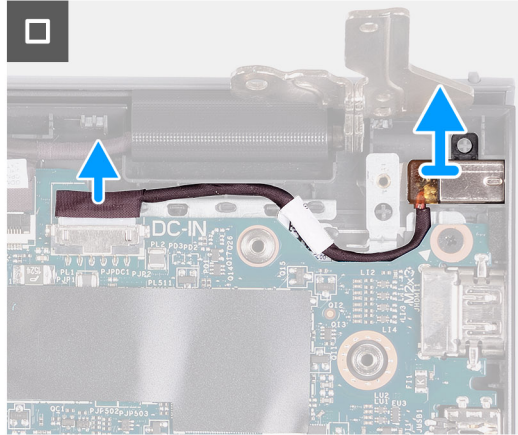
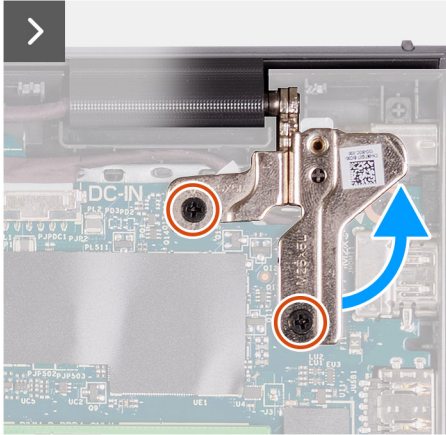
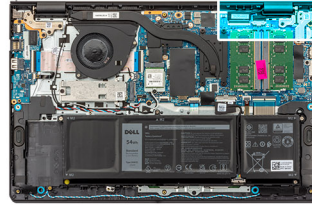

Steps

1. Remove the two screws (M2.5x5) that secure the right display hinge to the system board and the palm-rest and keyboard assembly.
2. Using a plastic scribe, lift the right display hinge away from the palm-rest and keyboard assembly to access the power-adapter port.
3. Disconnect the power-adapter port cable from the connector on the system board.
4. Remove the power-adapter port from the slot on the palm-rest and keyboard assembly.

i NOTE: The power-adapter port is secured in place by the right display hinge. There is no screw, tape, or adhesives securing the power-adapter port to the palm rest. As a result, technicians should take note of whether the power-adapter port has fallen out of the computer during subsequent removal procedures.

Installing the power-adapter port

⚠ CAUTION: The information in this section is intended for authorized service technicians only.

Prerequisites

If you are replacing a component, remove the existing component before performing the installation procedure.

About this task

The following images indicate the location of the power-adapter port and provide a visual representation of the installation procedure.



2x
M2.5x5

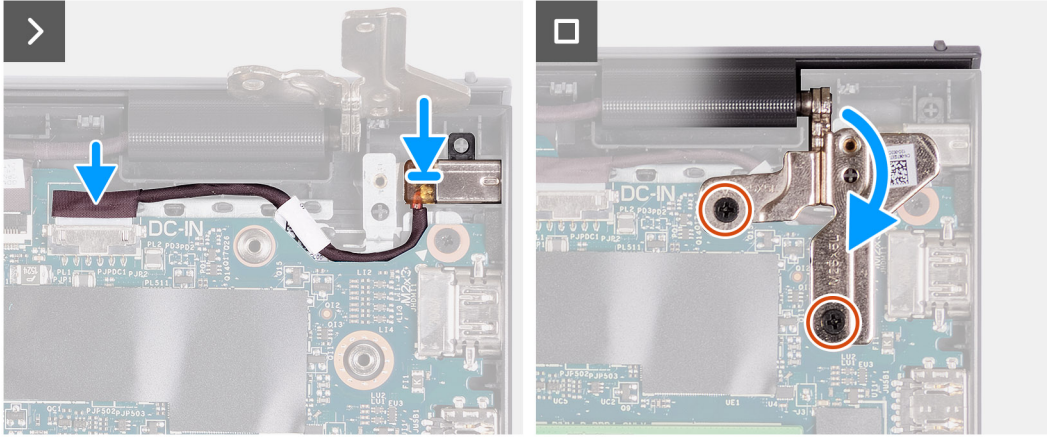
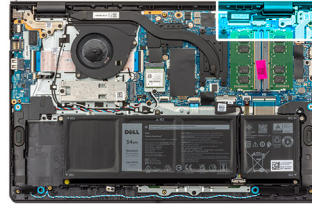

Steps

1. Align and place the power-adaptor port in the slot on the palm-rest and keyboard assembly.
i **NOTE:** The power-adaptor port is secured in place by the right display hinge. There is no screw, tape, or adhesives securing the power-adaptor port to the palm rest. As a result, technicians should take note of whether the power-adaptor port has fallen out of the computer during subsequent removal procedures.
2. Connect the power-adaptor port cable to the connector on the system board.
3. Close the right display hinge downwards to align the screw holes on the right display hinge to the screw holes on the system board and the palm-rest and keyboard assembly.
4. Replace the two screws (M2.5x5) to secure the right display hinge to the system board and the palm-rest and keyboard assembly.

Next steps

1. Install the [base cover](#).
2. Follow the procedure in [After working inside your computer](#).

Display assembly

Removing the display assembly

⚠ CAUTION: The information in this section is intended for authorized service technicians only.

Prerequisites

1. Follow the procedure in [Before working inside your computer](#).
2. Remove the [base cover](#).
3. Remove the [wireless card](#).
i **NOTE:** This procedure applies only to systems shipped with a plastic chassis.

About this task

The following images indicate the location of the display assembly and provide a visual representation of the removal procedure.



4x
M2.5x5

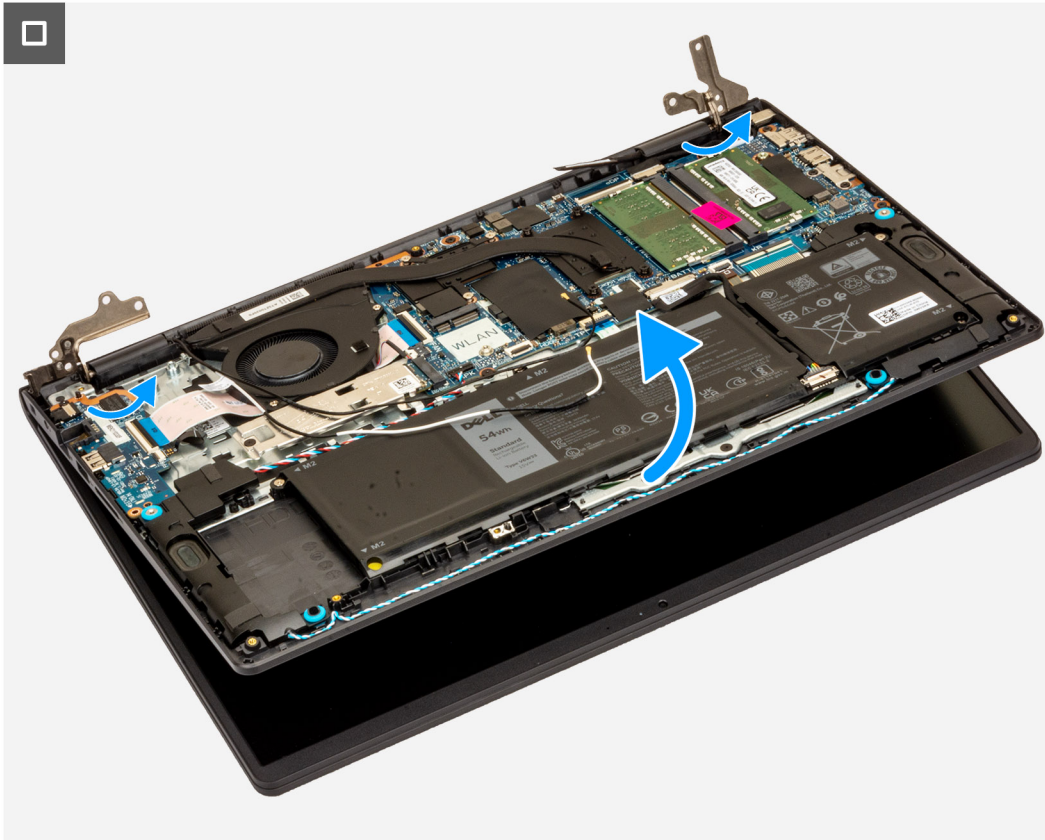
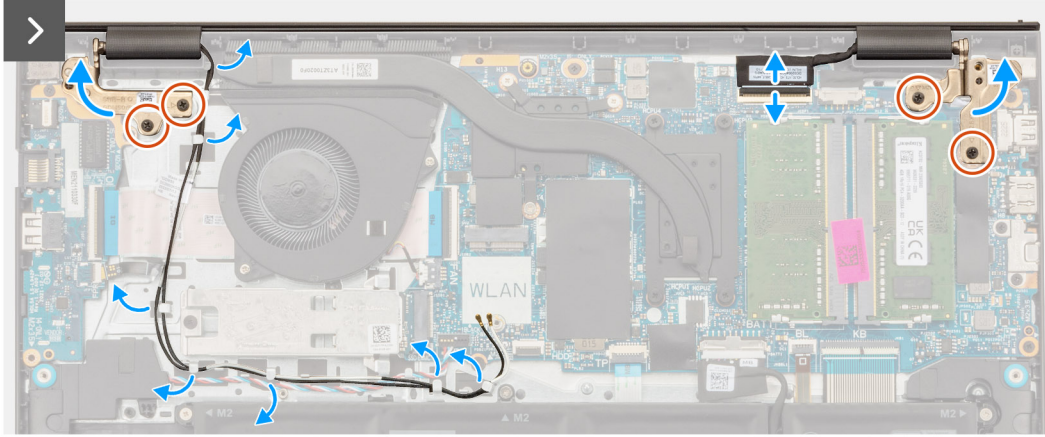
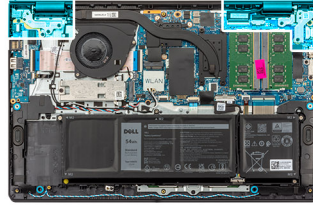



Steps

1. Disconnect the speaker cable from the connector on the system board.
i **NOTE:** This step applies only to computers shipped with a plastic chassis.
2. Disconnect the display cable from the connector on the system board.
3. Unroute the wireless-antenna cable from the routing guides on the palm-rest and keyboard assembly.
i **NOTE:** This step applies only to computers shipped with a plastic chassis.
4. Remove the four screws (M2.5x5) that secure the display hinges to the palm-rest and keyboard assembly.
5. Using a plastic scribe, lift the left and right hinges away from the palm-rest and keyboard assembly.
6. Lift the palm-rest and keyboard assembly at an angle to free it from the hinges and remove it from the display assembly.
i **NOTE:** For computers shipped with an aluminum chassis, the display assembly is a Hinge-Up Design (HUD) assembly and cannot be further disassembled once it is removed from the palm-rest and keyboard assembly. If any components in the display assembly are malfunctioning and are required to be replaced, replace the entire display assembly.
i **NOTE:** The power-adaptor port is secured in place by the right display hinge. There is no screw, tape, or adhesives securing the power-adaptor port to the palm-rest. As a result, technicians should take note of whether the power-adaptor port has fallen out of the computer during subsequent removal procedures.

Installing the display assembly

⚠ CAUTION: The information in this section is intended for authorized service technicians only.

Prerequisites

If you are replacing a component, remove the existing component before performing the installation procedure.

About this task

NOTE: Ensure that the display hinges are opened to the maximum before replacing the display assembly on the palm-rest and keyboard assembly.

The following images indicate the location of the display assembly and provide a visual representation of the installation procedure.



4x
M2.5x5

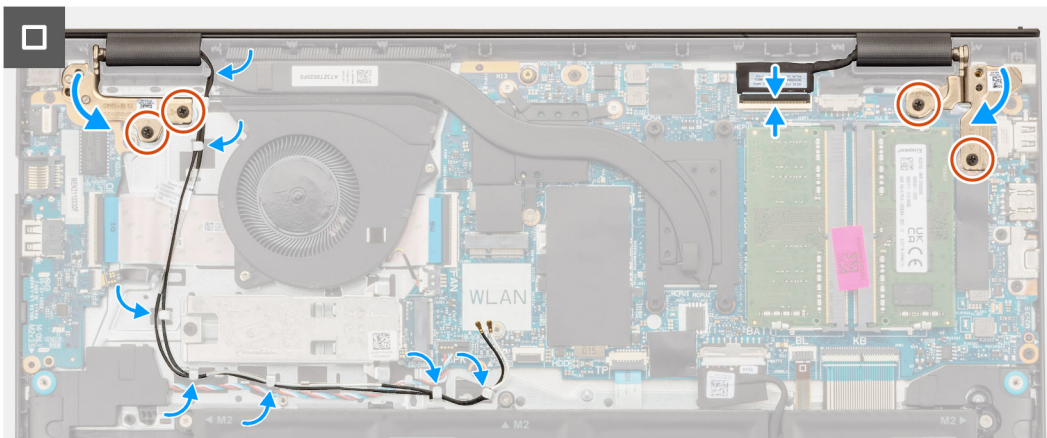
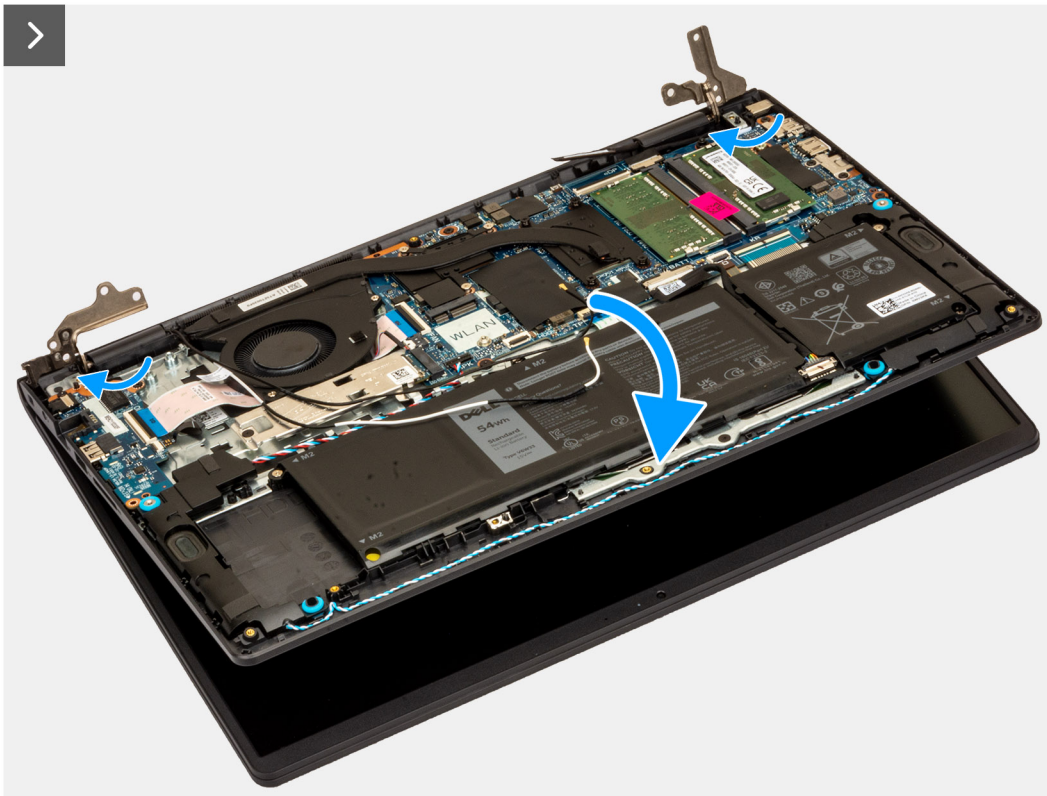
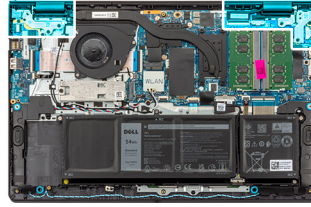

Steps

1. Place the display assembly on a clean and flat surface.

2. Slide the palm-rest and keyboard assembly at an angle and place the palm-rest and keyboard assembly on the display assembly.
 - i** **NOTE:** The power-adaptor port is secured in place by the right display hinge. There is no screw, tape, or adhesives securing the power-adaptor port to the palm-rest. As a result, technicians should take note of whether the power-adaptor port has fallen out of the computer during subsequent removal procedures.
3. Gently press down on the display hinges to align the screw holes on the display hinges with the screw holes on the palm-rest and keyboard assembly.
4. Replace the four screws (M2.5x5) to secure the display hinges to the palm-rest and keyboard assembly.
5. Route the wireless-antenna cables through the routing guides on the palm-rest and keyboard assembly.
 - i** **NOTE:** This step applies only to computers shipped with a plastic chassis.

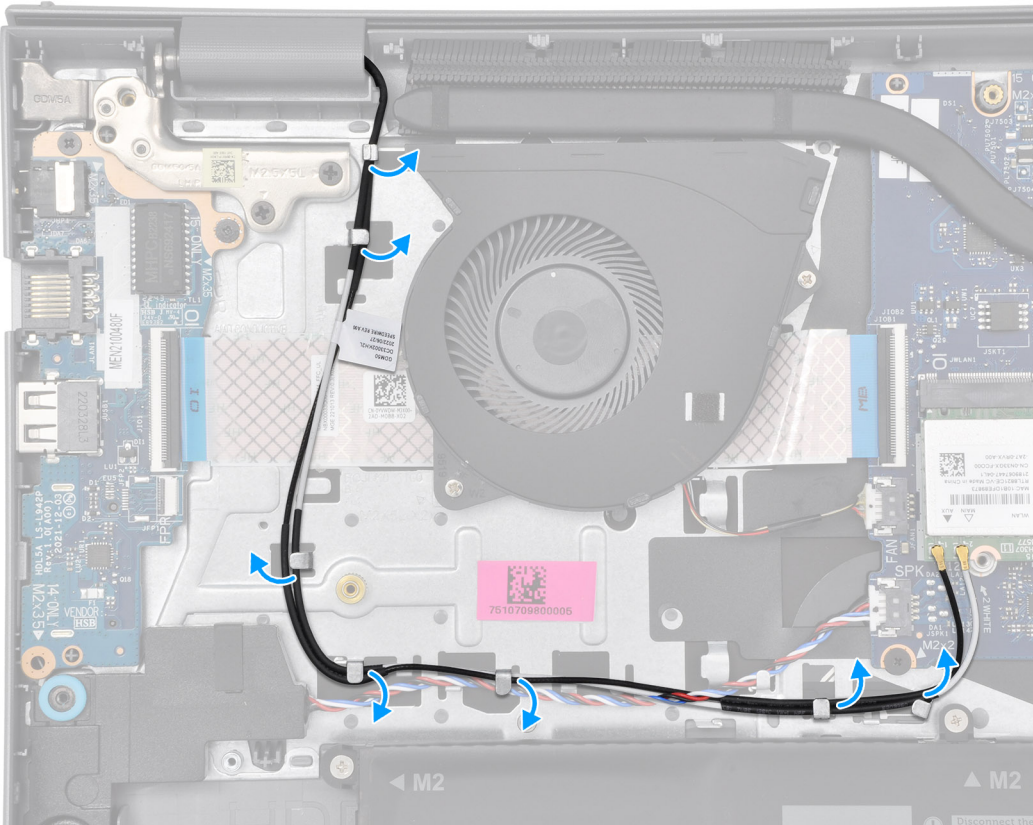

6. Route the speaker cable through the routing guides on the palm-rest and keyboard assembly.
 - i** **NOTE:** This step applies only to computers shipped with a plastic chassis.
7. Connect the speaker cable to the connector on the system board.
 - i** **NOTE:** This step applies only to computers shipped with a plastic chassis.
8. Connect the display cable to the connector on the system board.

Next steps

1. Install the [wireless card](#).
 - i** **NOTE:** This procedure applies only to systems shipped with a plastic chassis.
2. Install the [base cover](#).
3. Follow the procedure in [After working inside your computer](#).

Display hinge caps

Removing the display hinge caps

 **CAUTION:** The information in this section is intended for authorized service technicians only.

Prerequisites

1. Follow the procedure in [Before working inside your computer](#).
2. Remove the [base cover](#).
3. Remove the [wireless card](#).
4. Remove the [display assembly](#).

About this task

 **NOTE:** This procedure applies only to computers with a plastic chassis.

The following images indicate the location of the display hinge caps and provide a visual representation of the removal procedure.

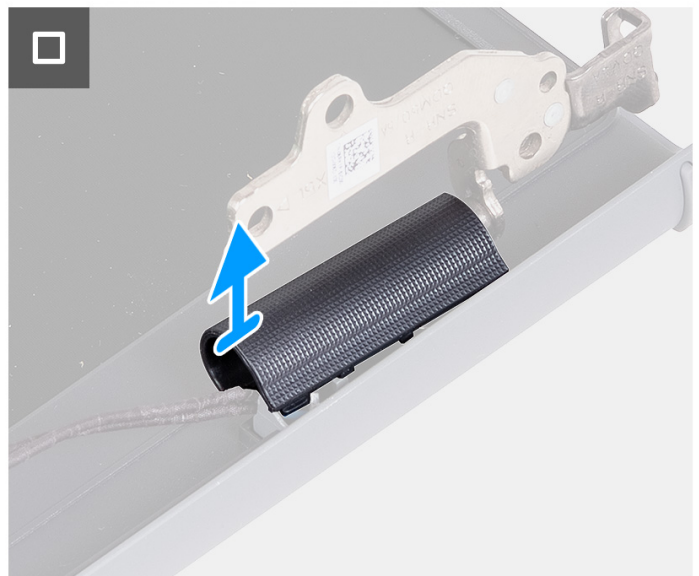
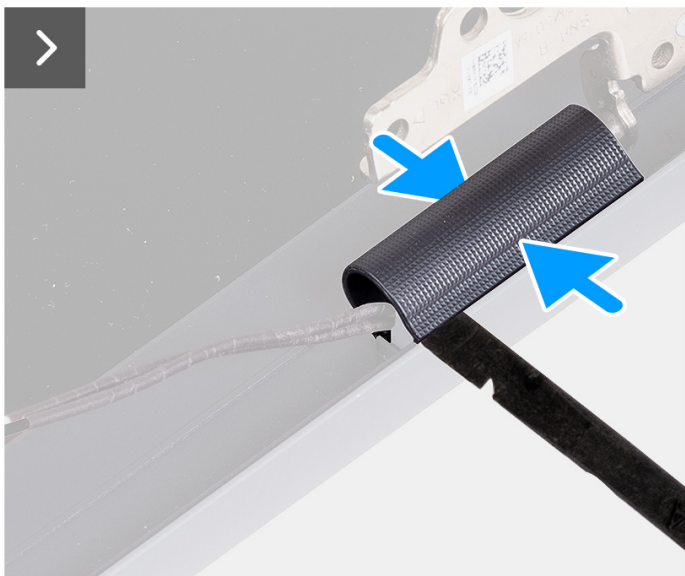
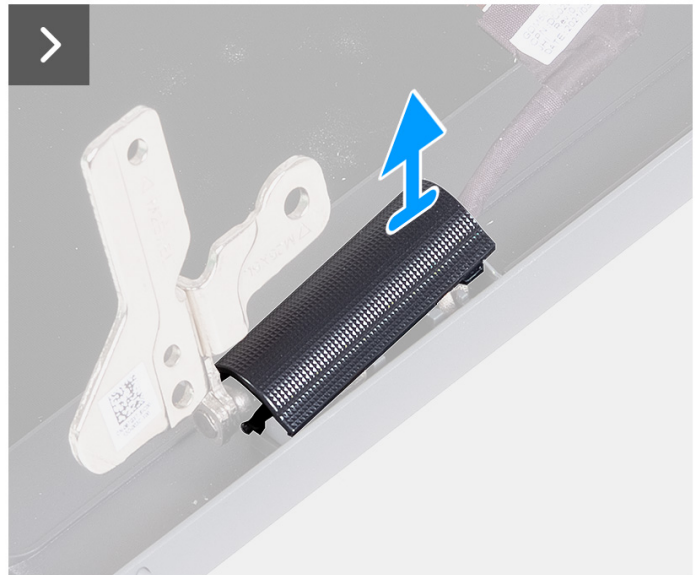
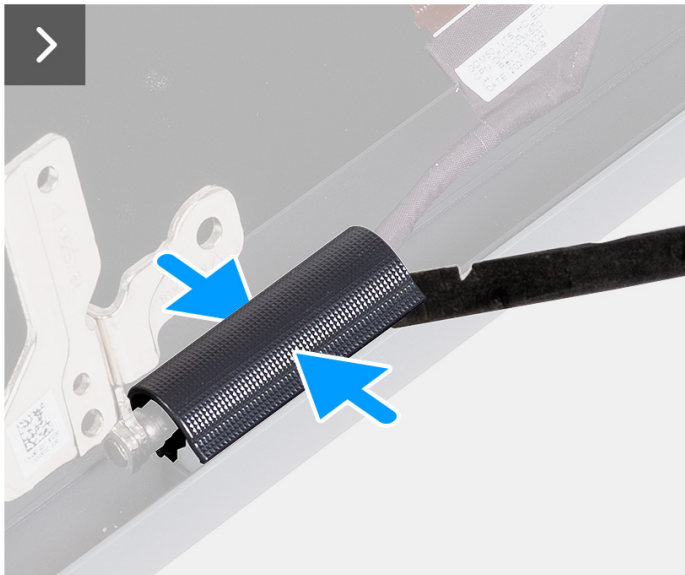
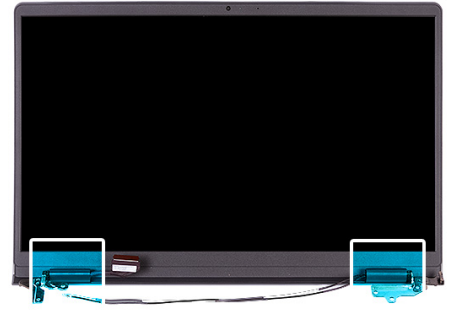

Steps

1. Place the display assembly on a clean, flat surface and gently open the display hinges to at least 90 degrees.



2. Using a plastic scribe, pry open the left display-hinge cap from its right side and remove it from the left display hinge.
3. Using a plastic scribe, pry open the right display-hinge cap from its left side and remove it from the right display hinge.

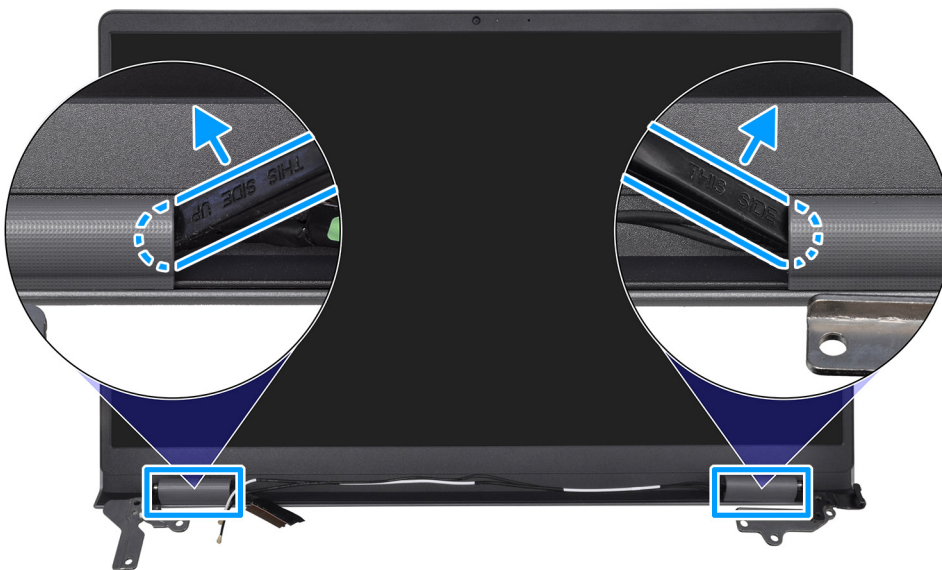

Installing the display hinge caps

CAUTION: The information in this section is intended for authorized service technicians only.

Prerequisites

If you are replacing a component, remove the existing component before performing the installation procedure.

About this task

NOTE: This procedure applies only to computers with a plastic chassis.

The following images indicate the location of the display hinge caps and provide a visual representation of the installation procedure.

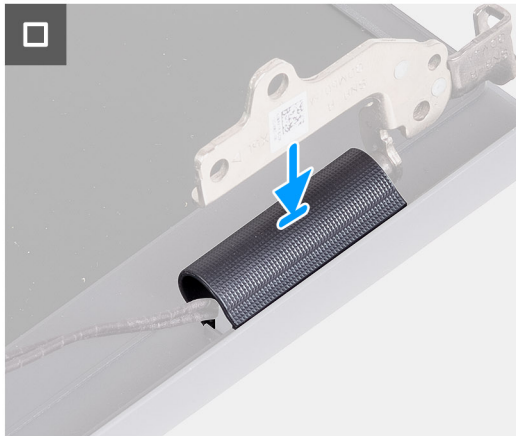
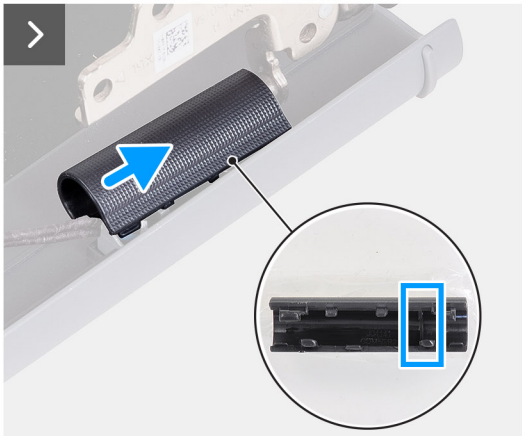
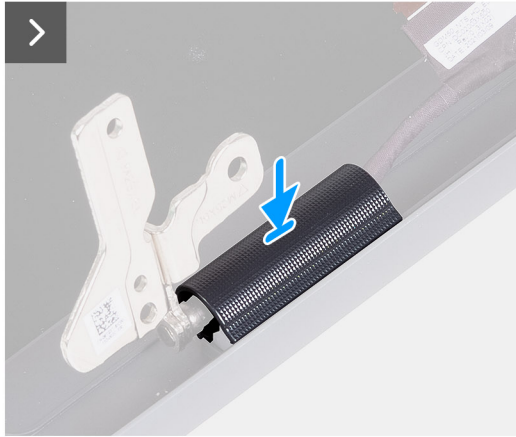
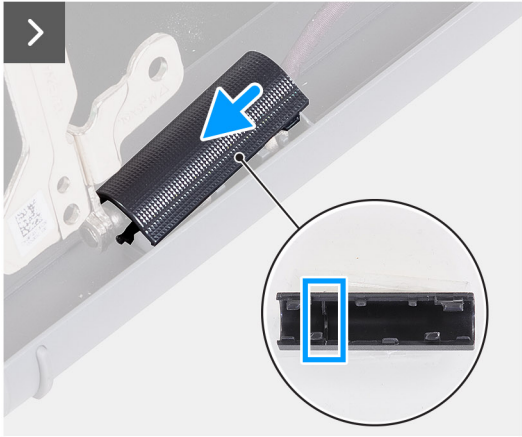

Steps

1. Align the rib, inside the right display-hinge cap, to the left-outer side of the right display hinge.
2. Push the right display-hinge cap down on the right display hinge, until it clicks in place.
3. Align the rib, inside the left display-hinge cap, to the right-outer side of the left display hinge.
4. Push the left display-hinge cap down on the right display hinge, until it clicks in place.

Next steps

1. Install the [display assembly](#).
2. Install the [wireless card](#).
3. Install the [base cover](#).
4. Follow the procedure in [After working inside your computer](#).

Display bezel

Removing the display bezel

CAUTION: The information in this section is intended for authorized service technicians only.

Prerequisites

1. Follow the procedure in [Before working inside your computer](#).
2. Remove the [base cover](#).
3. Remove the [wireless card](#).
4. Remove the [display assembly](#).
5. Remove the [display hinge caps](#).

About this task

NOTE: This procedure applies only to computers with a plastic chassis.

The following image indicates the location of the display bezel and provides a visual representation of the removal procedure.

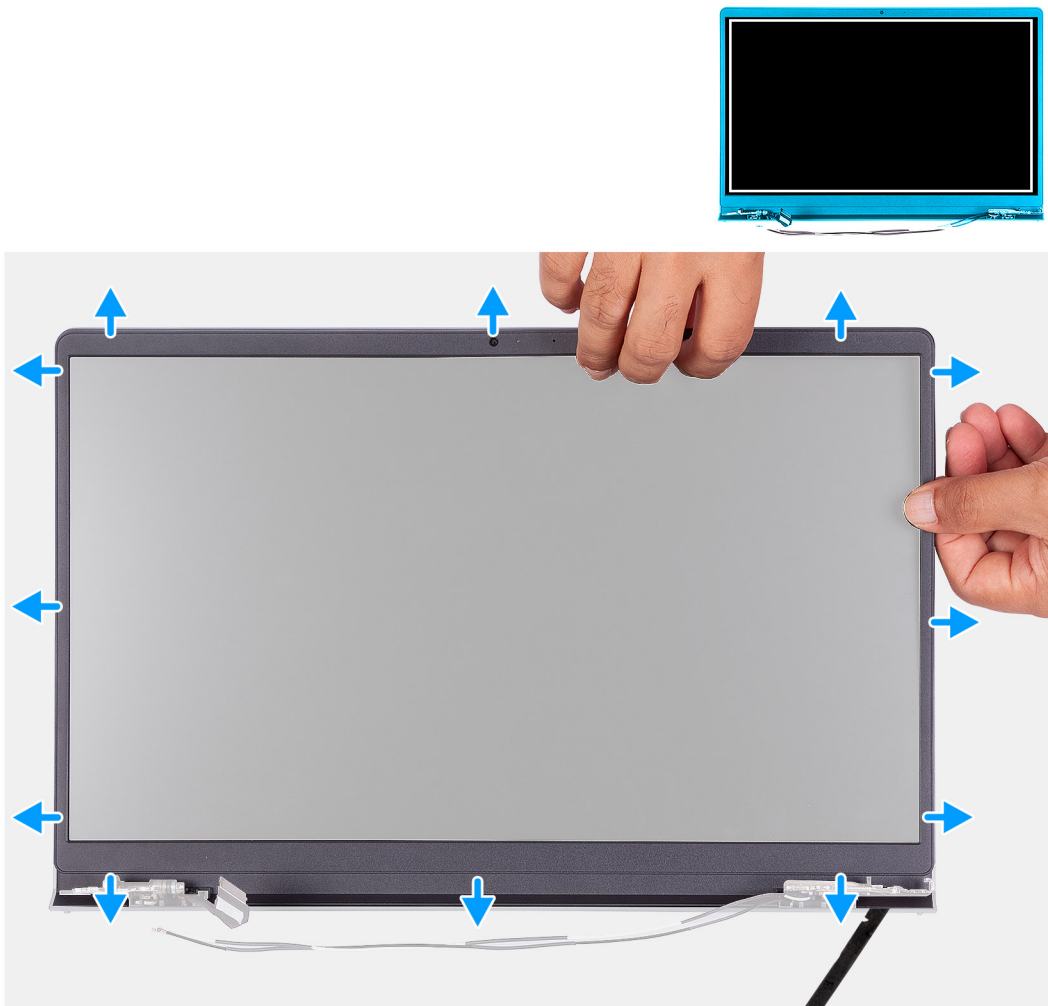

Steps

1. Using a plastic scribe, pry open the display bezel from the outer edge of openings at the bottom side of the display assembly, near the display hinges.

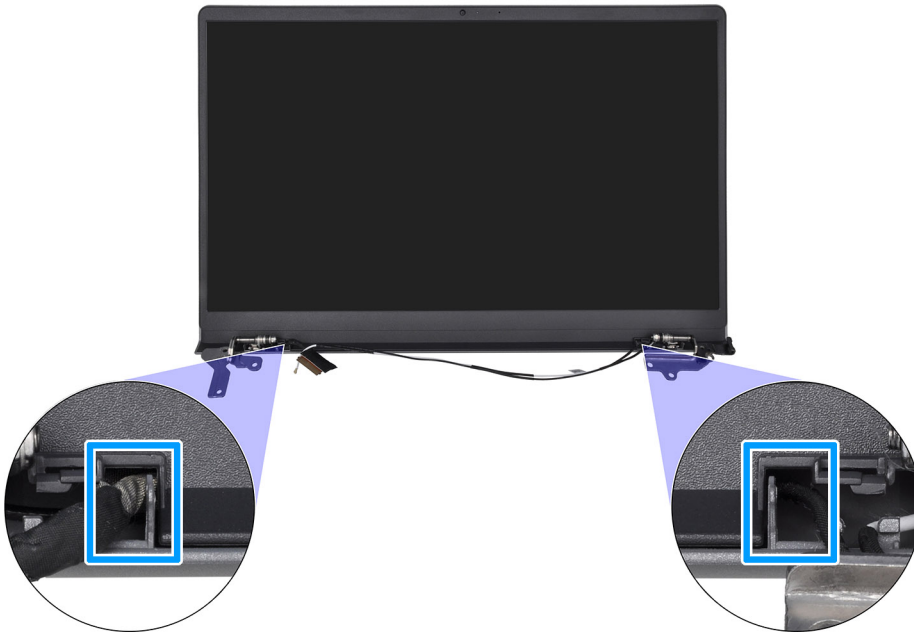

2. Carefully pry open the outer edge of the bottom side of the display bezel.
3. Using the plastic scribe, pry open the outside edge of the left, right, and top sides of the display bezel.



4. Lift and remove the display bezel from the display assembly.

CAUTION: DO NOT use a plastic scribe or any other objects to pry up the display bezel in the manner shown below, as the pressure applied on the display panel by the scribe may damage the display panel.



Installing the display bezel

CAUTION: The information in this section is intended for authorized service technicians only.

Prerequisites

If you are replacing a component, remove the existing component before performing the installation procedure.

About this task

NOTE: This procedure applies only to computers with a plastic chassis.

The following image indicates the location of the display bezel and provides a visual representation of the installation procedure.



Steps

1. Place the display assembly on a clean and flat surface.
2. Align and place the display bezel on the display assembly.
3. Starting from the top corner, press on the display bezel and work around the entire bezel until it clicks onto the display assembly.

Next steps

1. Install the [display hinge caps](#).
2. Install the [display assembly](#).
3. Install the [wireless card](#).
4. Install the [base cover](#).
5. Follow the procedure in [After working inside your computer](#).

Display hinges

Removing the display hinges

 **CAUTION:** The information in this section is intended for authorized service technicians only.

Prerequisites

1. Follow the procedure in [Before working inside your computer](#).
2. Remove the [base cover](#).
3. Remove the [wireless card](#).
4. Remove the [display assembly](#).
5. Remove the [display hinge caps](#).
6. Remove the [display bezel](#).

About this task

 **NOTE:** This procedure applies only to computers with a plastic chassis.

The following images indicate the location of the display hinges and provide a visual representation of the removal procedure.



6x
M2.5x3.8

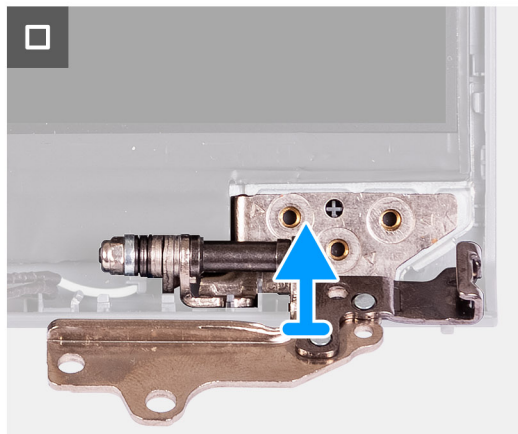
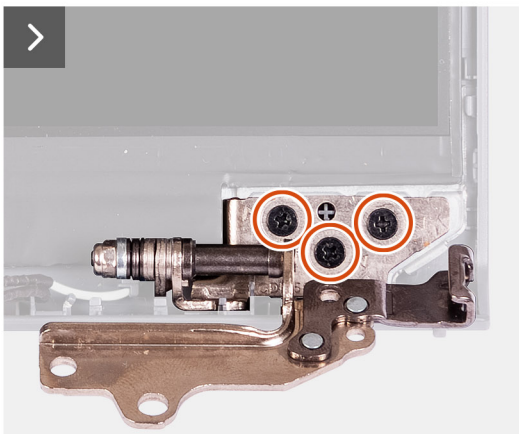
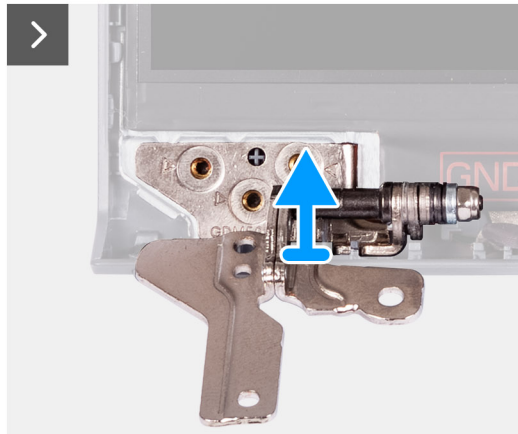

Steps

1. Remove the three screws (M2.5x3.8) that secure the left display hinge to the display panel and back cover.
2. Lift and remove the left display hinge from the display assembly.
3. Remove the three screws (M2.5x3.8) that secure the right display hinge to the display panel and back cover.
4. Lift and remove the right display hinge from the display assembly.

Installing the display hinges

CAUTION: The information in this section is intended for authorized service technicians only.

Prerequisites

If you are replacing a component, remove the existing component before performing the installation procedure.

About this task

NOTE: This procedure applies only to computers with a plastic chassis.

The following images indicate the location of the display hinges and provide a visual representation of the installation procedure.



6x
M2.5x3.8

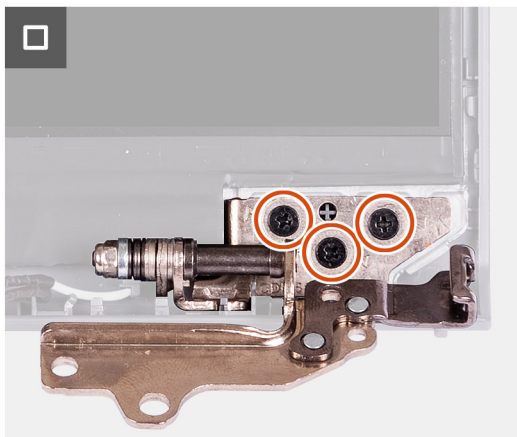
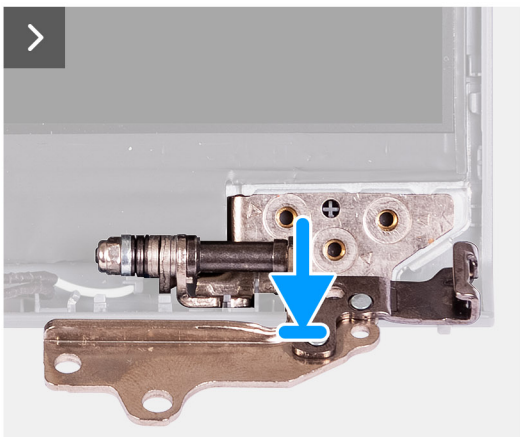
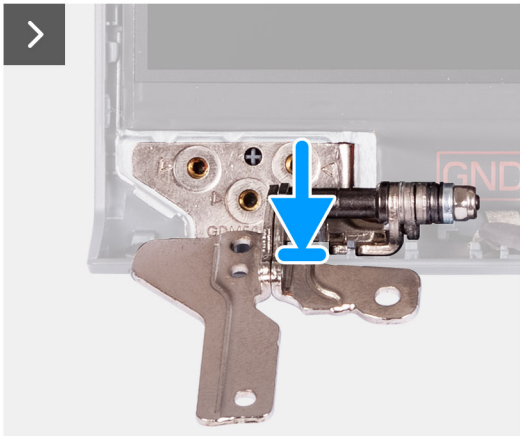

Steps

1. Align and place the left display hinge on the display assembly.
2. Replace the three screws (M2.5x3.8) to secure the left display hinge to the display panel and back cover.
3. Align and place the right display hinge on the display assembly.
4. Replace the three screws (M2.5x3.8) to secure the right display hinge to the display panel and back cover.

Next steps

1. Install the [display bezel](#).
2. Install the [display hinge caps](#).
3. Install the [display assembly](#).
4. Install the [wireless card](#).
5. Install the [base cover](#).
6. Follow the procedure in [After working inside your computer](#).

Display panel

Removing the display panel

 **CAUTION:** The information in this section is intended for authorized service technicians only.

Prerequisites

1. Follow the procedure in [Before working inside your computer](#).
2. Remove the [base cover](#).
3. Remove the [wireless card](#).
4. Remove the [display assembly](#).
5. Remove the [display hinge caps](#).
6. Remove the [display bezel](#).
7. Remove the [display hinges](#).

About this task

 **NOTE:** This procedure applies only to computers with a plastic chassis.

The following images indicate the location of the display panel and provide a visual representation of the removal procedure.



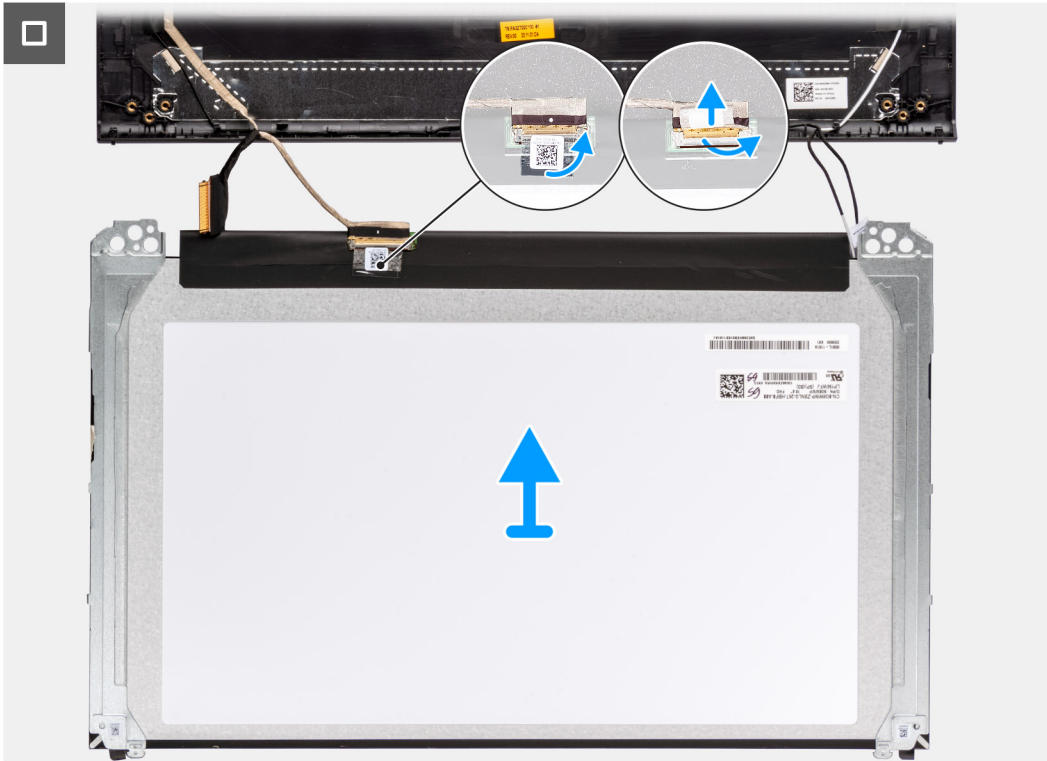

Steps

1. Using a plastic scribe, pry the display panel from the bottom-right corner.



2. Using your hands, gently pry the display panel from the tabs along the right side of the display back-cover and antenna assembly.

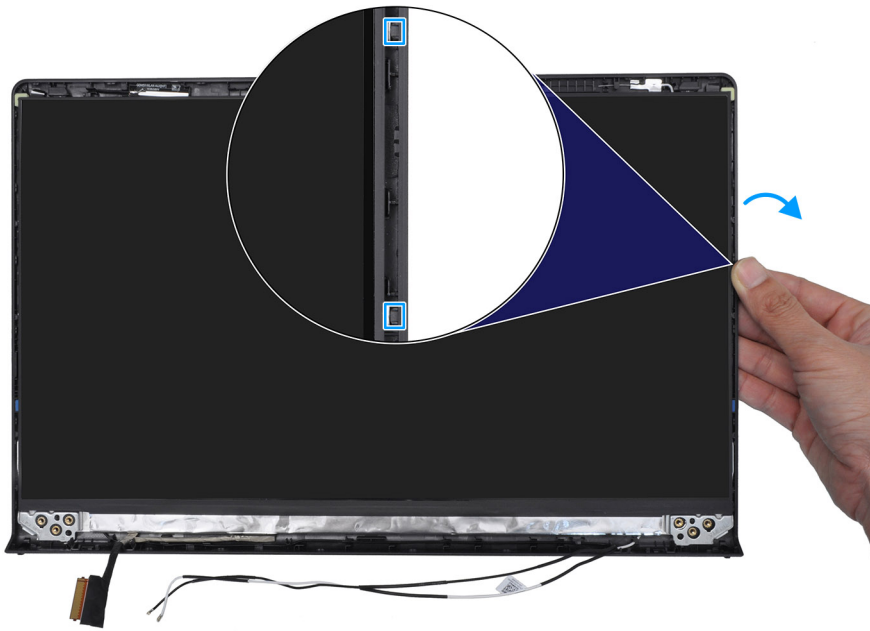

3. Repeat step 1 and 2 for the left side of the display panel assembly.

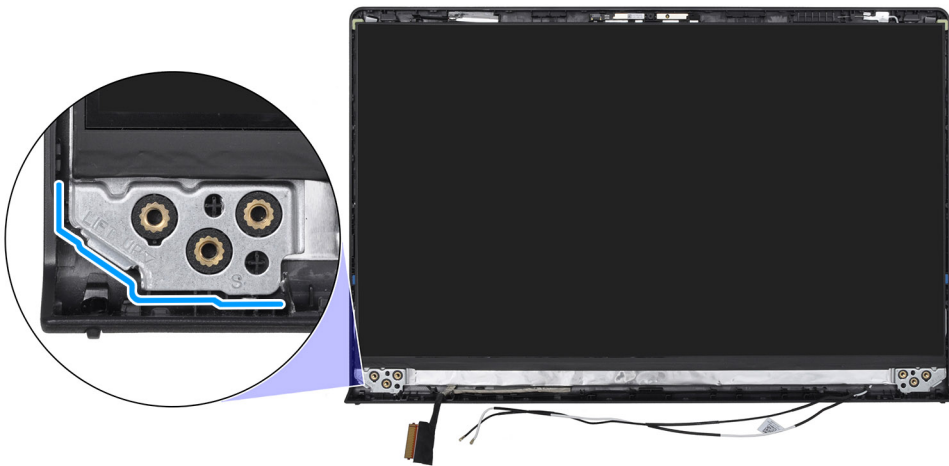

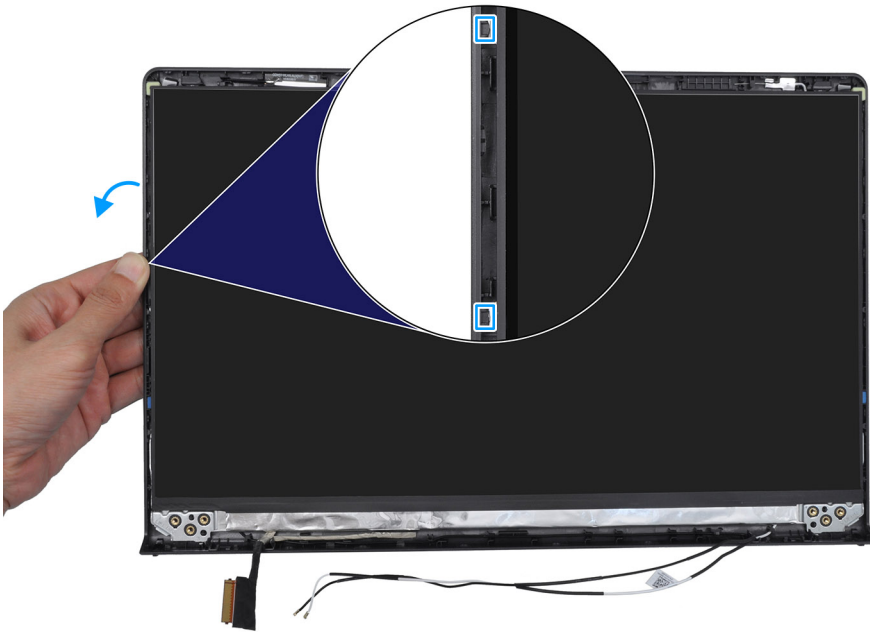

4. Lift the bottom side of the display panel and slide it downward to release the display brackets from the slots at the top side of the display back-cover.

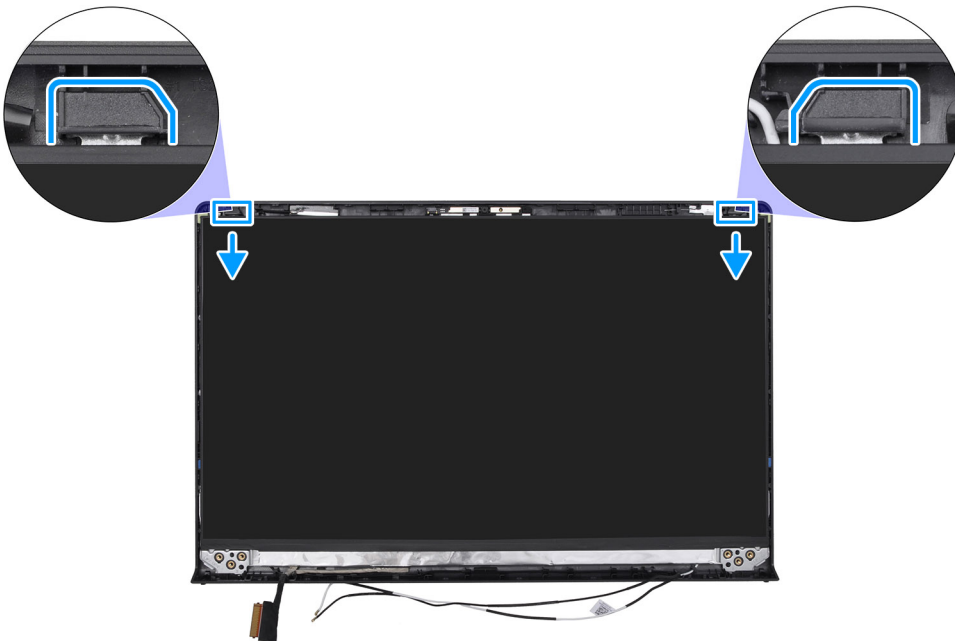

5. Gently flip the display panel assembly forward, peel back the tape that secures the display cable to the connector on the rear of the display panel.

i **NOTE:** Ensure that the panel has a clean and smooth surface to rest on, to prevent damage.

6. Disconnect the display cable from the connector on the display panel and remove the display panel.

i **NOTE:** The display panel is assembled with the display brackets as a single service part. DO NOT pull the two pieces of elastic tape and separate the brackets from the panel.



Installing the display panel

CAUTION: The information in this section is intended for authorized service technicians only.

Prerequisites

If you are replacing a component, remove the existing component before performing the installation procedure.

About this task

NOTE: This procedure applies only to computers with a plastic chassis.

The following images indicate the location of the display panel and provide a visual representation of the installation procedure.

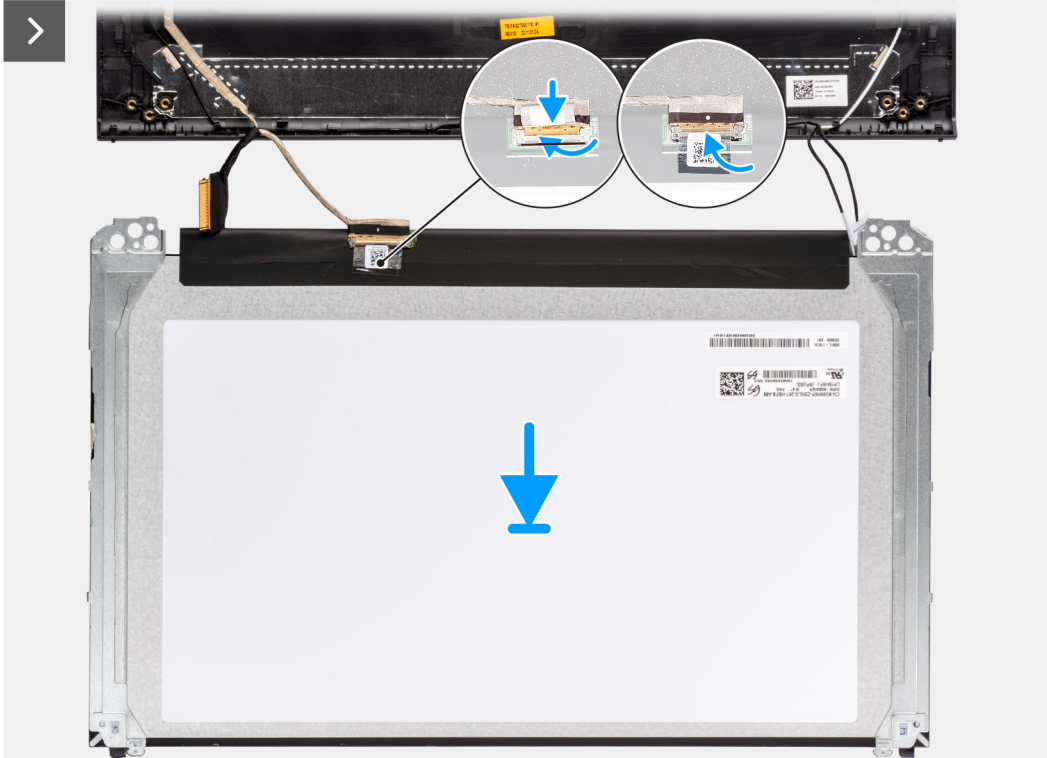



Steps

1. Place the display panel and display assembly on a clean and flat surface.
2. Connect the display cable to the connector on the display panel and close the latch.
3. Adhere the tape to secure the display cable to the connector on the display panel.
4. Turn the display panel over and place the display panel on the display back-cover.
5. Lift the bottom side of the display panel and slide the top side into the slots at the top of the display back-cover.
6. Gently push down on the edges of the display panel until it clicks into the tabs on the display back-cover.

Next steps

1. Install the [display hinges](#).
2. Install the [display bezel](#).
3. Install the [display hinge caps](#).
4. Install the [display assembly](#).
5. Install the [wireless card](#).
6. Install the [base cover](#).
7. Follow the procedure in [After working inside your computer](#).

Camera

Removing the camera

CAUTION: The information in this section is intended for authorized service technicians only.

Prerequisites

1. Follow the procedure in [Before working inside your computer](#).
2. Remove the [base cover](#).
3. Remove the [wireless card](#).
4. Remove the [display assembly](#).
5. Remove the [display hinge caps](#).
6. Remove the [display bezel](#).
7. Remove the [display hinges](#).
8. Remove the [display panel](#).

About this task

NOTE: This procedure applies only to computers with a plastic chassis.

The following images indicate the location of the camera module and provide a visual representation of the removal procedure.

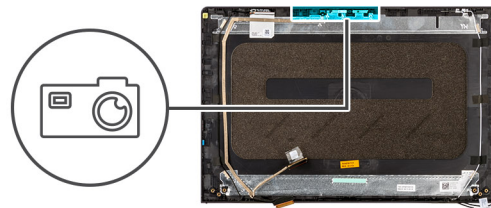

Steps

1. Disconnect the display cable from the connector on the camera module.
2. Using a plastic scribe, gently pry the camera off the display back-cover and antenna assembly.
3. Remove the camera module from the display assembly.

Installing the camera

CAUTION: The information in this section is intended for authorized service technicians only.

Prerequisites

If you are replacing a component, remove the existing component before performing the installation procedure.

About this task

NOTE: This procedure applies only to computers with a plastic chassis.

The following images indicate the location of the camera module and provide a visual representation of the installation procedure.

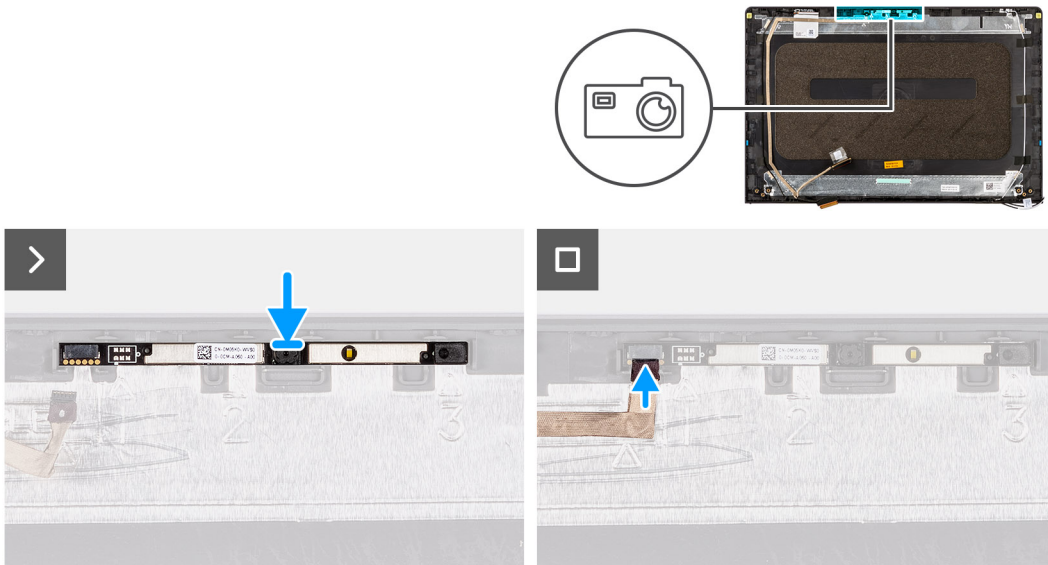

Steps

1. Using the alignment post, adhere the camera module on the display back-cover and antenna assembly.
2. Connect the display cable to the connector on the camera module.

Next steps

1. Install the [display panel](#).
2. Install the [display hinges](#).
3. Install the [display bezel](#).
4. Install the [display hinge caps](#).
5. Install the [display assembly](#).
6. Install the [wireless card](#).
7. Install the [base cover](#).
8. Follow the procedure in [After working inside your computer](#).

Display cable

Removing the display cable

CAUTION: The information in this section is intended for authorized service technicians only.

Prerequisites

1. Follow the procedure in [Before working inside your computer](#).
2. Remove the [base cover](#).
3. Remove the [wireless card](#).
4. Remove the [display assembly](#).
5. Remove the [display hinge caps](#).
6. Remove the [display bezel](#).
7. Remove the [display hinges](#).

8. Remove the [display panel](#).

About this task

NOTE: This procedure applies only to computers with a plastic chassis.

The following image indicates the location of the display cable and provides a visual representation of the removal procedure.

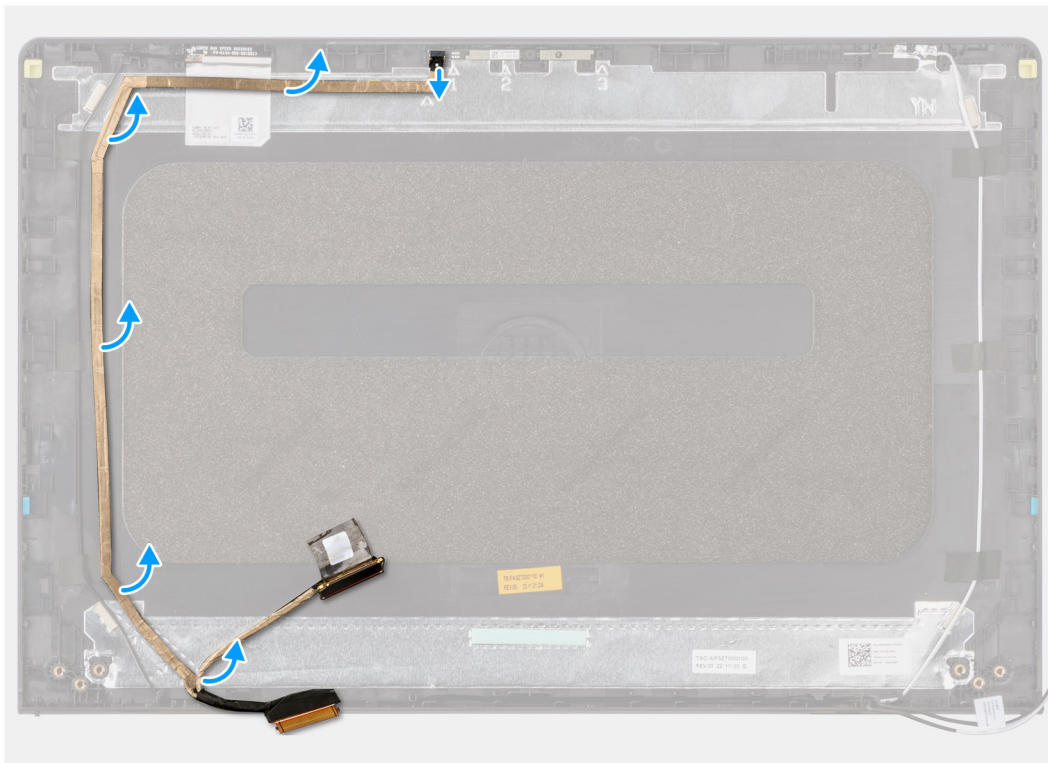
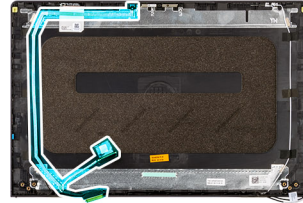

Steps

1. Disconnect the display eDP cable from the connector on the camera module.
2. Carefully peel back and remove the display eDP cable from the display back-cover and antenna assembly.

Installing the display cable

CAUTION: The information in this section is intended for authorized service technicians only.

Prerequisites

If you are replacing a component, remove the existing component before performing the installation procedure.

About this task

NOTE: This procedure applies only to computers with a plastic chassis.

The following image indicates the location of the display cable and provides a visual representation of the installation procedure.

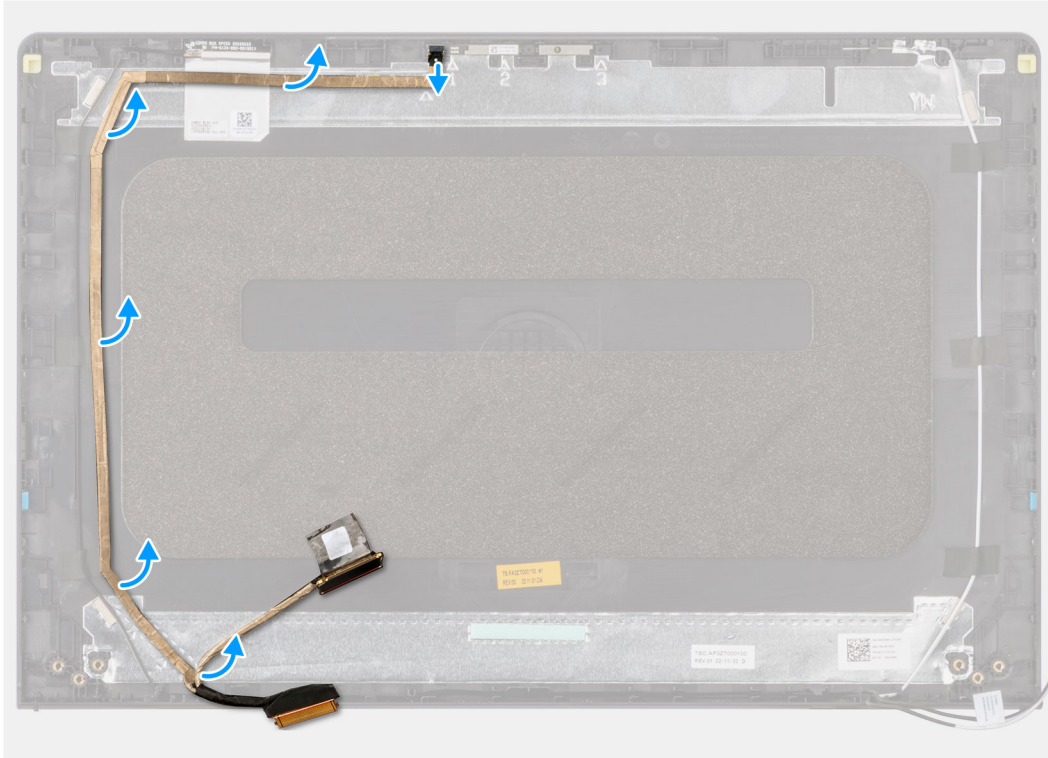

Steps

1. Adhere the display eDP cable to the display back-cover and antenna assembly.
2. Connect the display eDP cable to the connector on the camera module.

Next steps

1. Install the [display panel](#).
2. Install the [display hinges](#).
3. Install the [display bezel](#).
4. Install the [display hinge caps](#).
5. Install the [display assembly](#).
6. Install the [wireless card](#).
7. Install the [base cover](#).
8. Follow the procedure in [After working inside your computer](#).

Display back-cover and antenna assembly

Removing the display back-cover and antenna assembly

⚠ CAUTION: The information in this section is intended for authorized service technicians only.

Prerequisites

1. Follow the procedure in [Before working inside your computer](#).
2. Remove the [base cover](#).
3. Remove the [wireless card](#).
4. Remove the [display assembly](#).
5. Remove the [display hinge caps](#).
6. Remove the [display bezel](#).
7. Remove the [display hinges](#).
8. Remove the [display panel](#).
9. Remove the [camera](#).
10. Remove the [display cable](#).

About this task

NOTE: This procedure applies only to computers with a plastic chassis.

NOTE: The display back-cover and antenna assembly cannot be further disassembled once all the pre-removal parts procedures are completed. If the wireless antennas are malfunctioning and are required to be replaced, replace the entire display back-cover and antenna assembly.

The image below shows the display back-cover and antenna assembly after the pre-removal parts procedures have been performed for any display back-cover and antenna assembly replacement.



Steps

After performing the pre-requisites, you are left with the display back-cover and antenna assembly.

Installing the display back-cover and antenna assembly

CAUTION: The information in this section is intended for authorized service technicians only.

Prerequisites

If you are replacing a component, remove the existing component before performing the installation procedure.

About this task

NOTE: This procedure applies only to computers with a plastic chassis.

The following image indicates the location of the display back-cover and antenna assembly and provides a visual representation of the installation procedure.



Steps

Place the display back-cover and antenna assembly on a flat surface and perform the post-requisites to install the display back-cover and antenna assembly.

Next steps

1. Install the [display cable](#).
2. Install the [camera](#).
3. Install the [display panel](#).
4. Install the [display hinges](#).
5. Install the [display bezel](#).
6. Install the [display hinge caps](#).
7. Install the [display assembly](#).
8. Install the [wireless card](#).
9. Install the [base cover](#).
10. Follow the procedure in [After working inside your computer](#).

System board

Removing the system board

CAUTION: The information in this section is intended for authorized service technicians only.

Prerequisites

1. Follow the procedure in [Before working inside your computer](#).
2. Remove the [base cover](#).
3. Remove the [memory module](#).
4. Remove the [M.2 2230 solid-state drive](#) or the [M.2 2280 solid-state drive](#), whichever applicable.
5. Remove the [wireless card](#).
6. Remove the [fan](#).
7. Remove the [heat sink - integrated](#) or the [heat sink - discrete](#), whichever applicable.

NOTE: When removing the system board to replace/access other parts, the system board can be removed with the heat sink attached to it in order to simplify the procedure and preserve the thermal bond between the system board and heat sink.

About this task

The following image indicates the connectors on your system board.

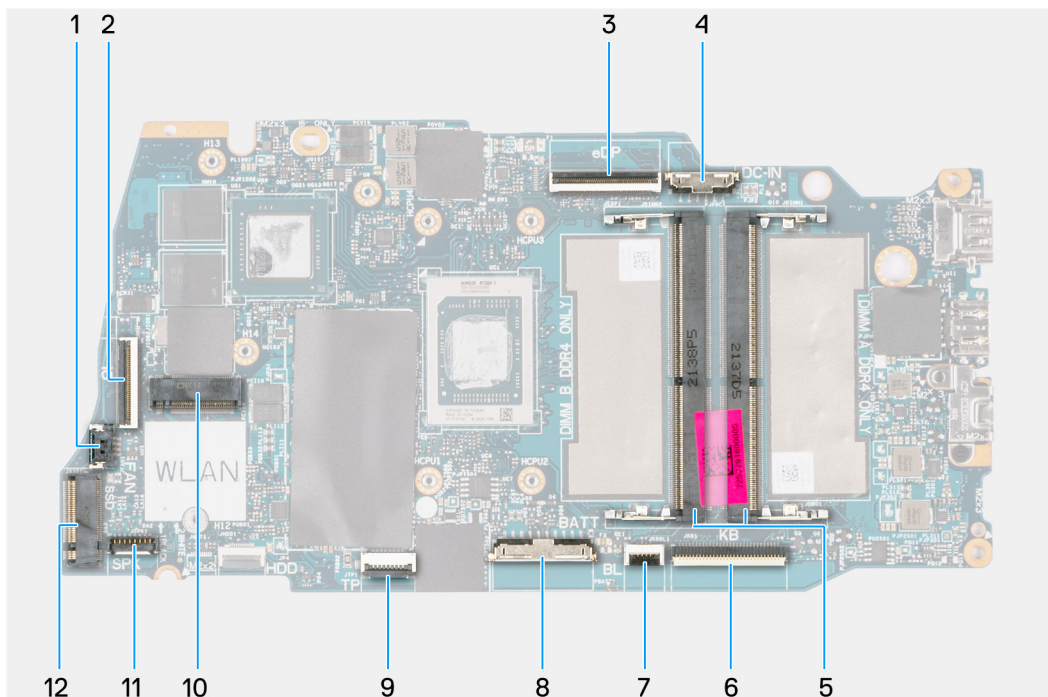

1. Fan cable connector
2. I/O daughter-board FFC connector
3. eDP connector
4. Power-adaptor port connector
5. Memory module connector
6. Keyboard FFC connector
7. Keyboard-backlight FPC connector
8. Battery connector
9. Touchpad FFC connector
10. Wireless card connector
11. Speaker cable connector
12. Speaker cable connector

12. M.2 solid-state drive connector

The following images indicate the location of the system board and provide a visual representation of the removal procedure.

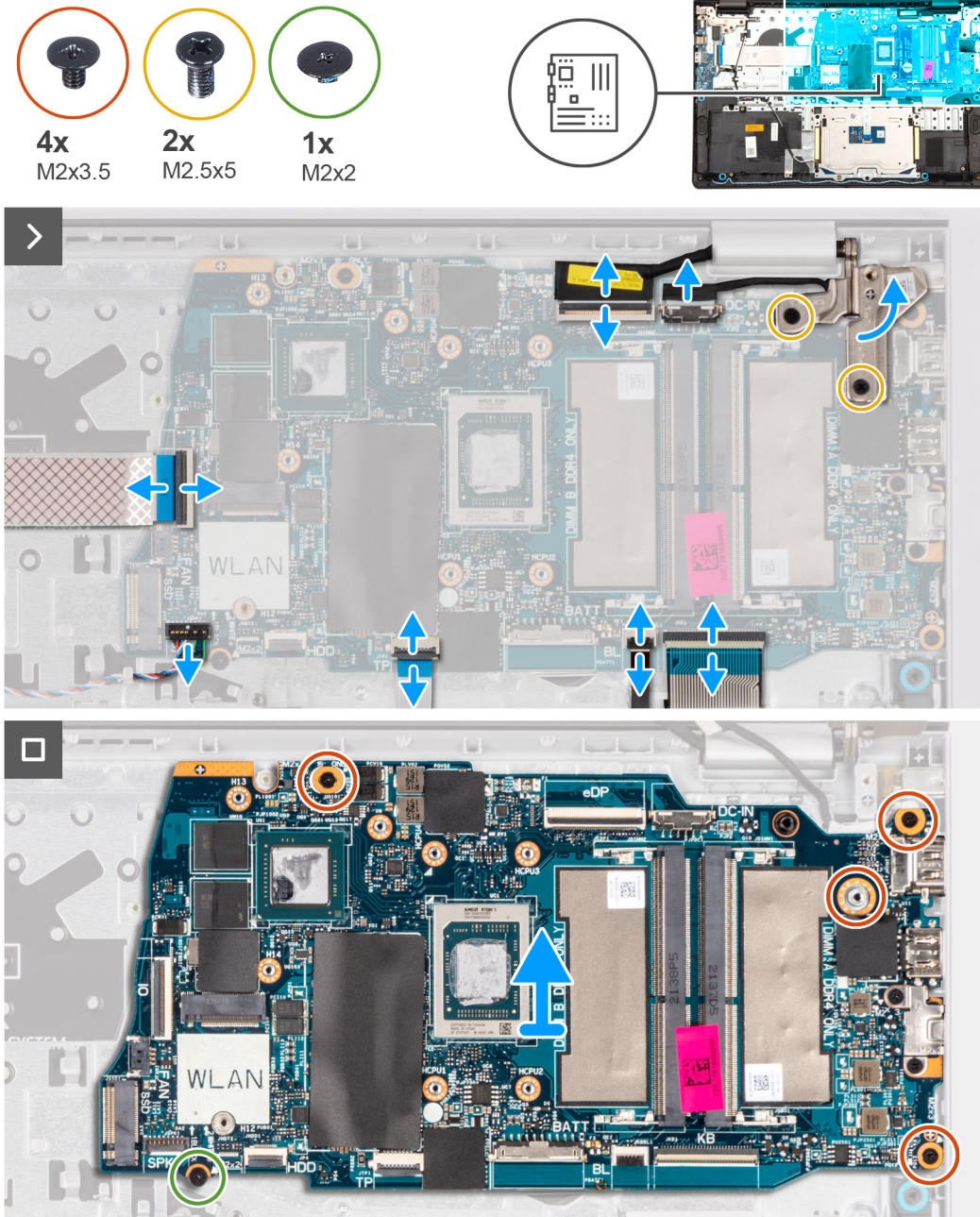

Steps

1. Remove the two screws (M2.5x5) that secure the right display hinge to the system board and the palm-rest and keyboard assembly.
2. Using a plastic scribe, lift the right display hinge away from the palm-rest and keyboard assembly.
3. Disconnect the following cables from the system board:
 - a. I/O daughter-board FFC
 - b. eDP cable
 - c. Power-adapter port cable
 - d. Keyboard FFC
 - e. Keyboard-backlight FPC

i NOTE: This step applies only to computers shipped with a keyboard backlight installed.

- f. Battery cable
 - g. Touchpad FFC
 - h. Speaker cable
4. Remove the screw (M2x2) and the four screws (M2x3.5) that secure the system board to the palm-rest and keyboard assembly.

NOTE: DO NOT remove the USB Type-C bracket from the system board, for individual replacement. The system board and the USB Type-C bracket are replaced as an assembly part.

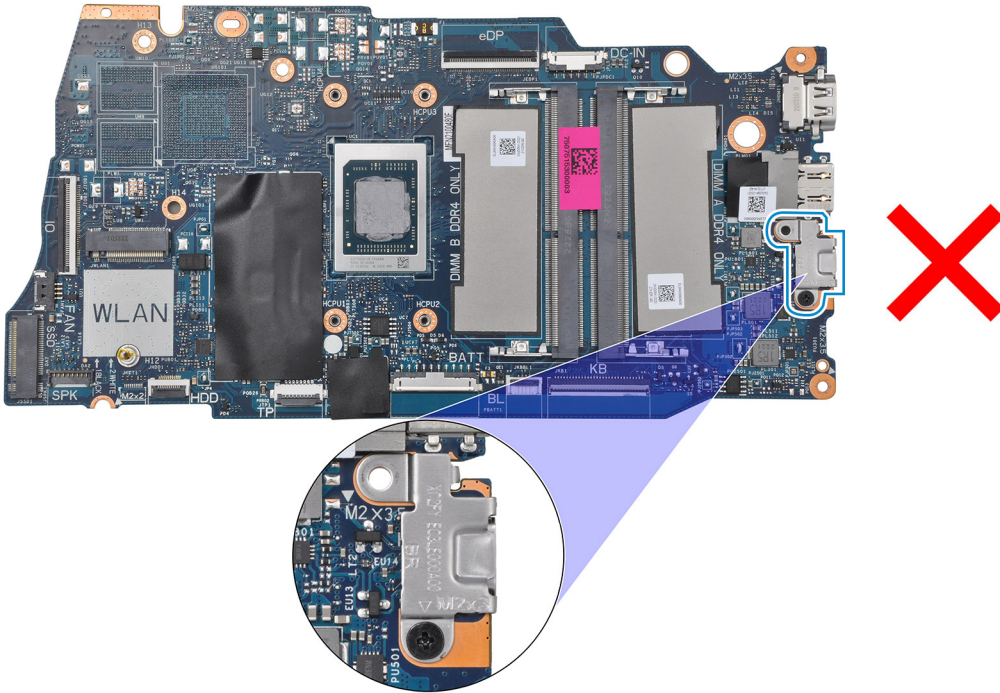

5. Carefully lift and remove the system board from the palm-rest and keyboard assembly.

Installing the system board

CAUTION: The information in this section is intended for authorized service technicians only.

Prerequisites

If you are replacing a component, remove the existing component before performing the installation procedure.

About this task

NOTE: When installing the system board to replace/access other parts, the system board can be installed with the heat sink attached to it in order to simplify the procedure and preserve the thermal bond between the system board and heat sink.

The following image indicates the connectors on your system board.

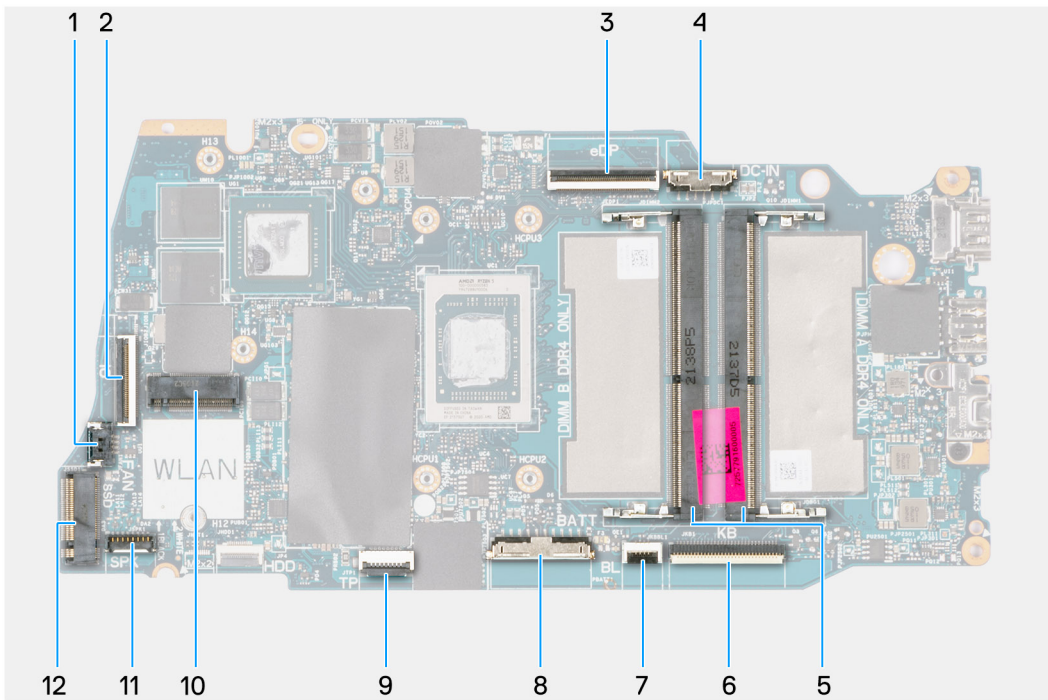

1. Fan cable connector
2. I/O daughter-board FFC connector
3. eDP connector
4. Power-adaptor port connector
5. Memory module connector
6. Keyboard FFC connector
7. Keyboard-backlight FPC connector
8. Battery connector
9. Touchpad FFC connector
10. Wireless card connector
11. Speaker cable connector
12. M.2 solid-state drive connector

The following images indicate the location of the system board and provide a visual representation of the installation procedure.

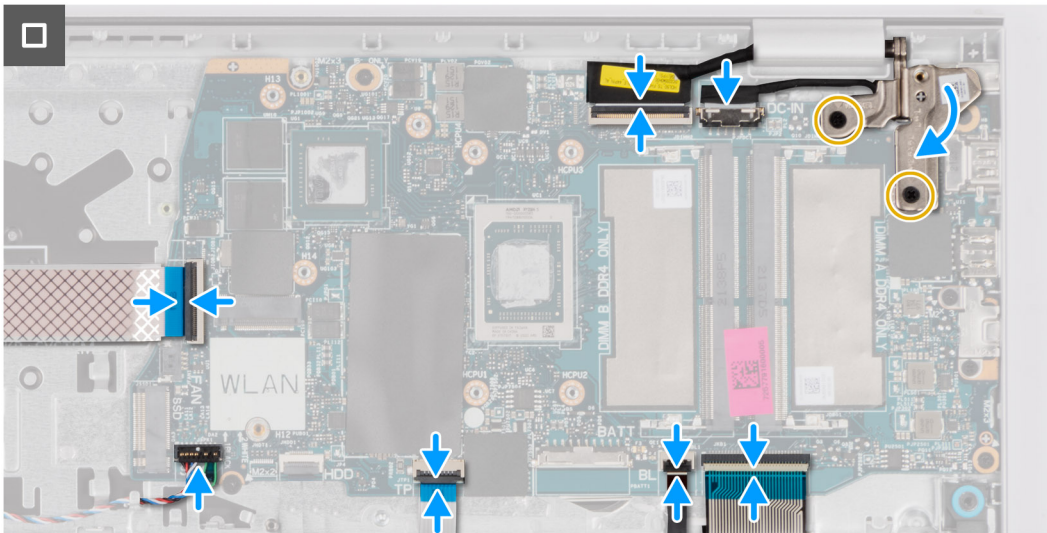
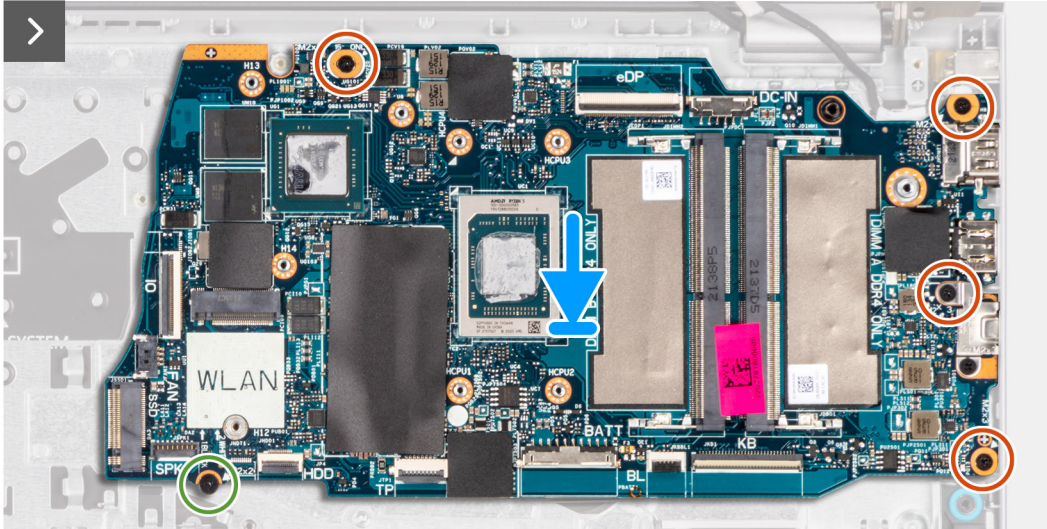
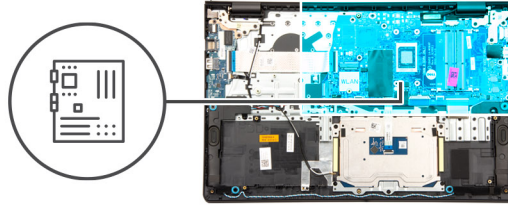
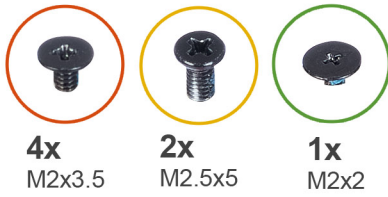

Steps

1. Align the ports on the system board to the port openings on the palm-rest and keyboard assembly.
2. At an angle, carefully slide and place the system board on the palm-rest and keyboard assembly.
3. Align the screw holes on the system board with the screw holes on the palm-rest and keyboard assembly.
4. Replace the screw (M2x2) and the four screws (M2x3.5) to secure the system board to the palm-rest and keyboard assembly.
5. Connect the following cables to the system board:
 - a. I/O daughter-board FFC
 - b. eDP cable
 - c. Power-adaptor port cable
 - d. Keyboard FFC
 - e. Keyboard-backlight FPC

NOTE: This step applies only to computers shipped with a keyboard backlight installed.

- f. Battery cable
 - g. Touchpad FFC
 - h. Speaker cable
6. Close the right display hinge downwards to align the screw holes on the right display hinge to the screw holes on the system board and the palm-rest and keyboard assembly.
 7. Replace the two screws (M2.5x5) to secure the right display hinge to the system board and the palm-rest and keyboard assembly.

Next steps

1. Install the [heat sink - integrated](#) or the [heat sink - discrete](#), whichever applicable.
2. Install the [fan](#).
3. Install the [wireless card](#).
4. Install the [M.2 2230 solid-state drive](#) or the [M.2 2280 solid-state drive](#), whichever applicable.
5. Install the [memory module](#).
6. Install the [base cover](#).
7. Follow the procedure in [After working inside your computer](#).

Palm-rest and keyboard assembly

Removing the palm-rest and keyboard assembly

 **CAUTION:** The information in this section is intended for authorized service technicians only.

Prerequisites

1. Follow the procedure in [Before working inside your computer](#).
2. Remove the [base cover](#).
3. Remove the [memory module](#).
4. Remove the [M.2 2230 solid-state drive](#) or the [M.2 2280 solid-state drive](#), whichever applicable.
5. Remove the [wireless card](#).
6. Remove the [speakers](#).
7. Remove the [fan](#).
8. Remove the [heat sink - integrated](#) or the [heat sink - discrete](#), whichever applicable.
9. Remove the [3-cell battery](#) or the [4-cell battery](#), whichever applicable.
10. Remove the [touchpad](#).
11. Remove the [I/O daughter-board cable](#).
12. Remove the [I/O daughter-board](#).
13. Remove the [power button](#) or the [power button with optional fingerprint reader](#), whichever applicable.
14. Remove the [power-adaptor port](#).
15. Remove the [display assembly](#).
16. Remove the [system board](#).

 **NOTE:** When removing the system board to replace/access other parts, the system board can be removed with the heat sink attached to it in order to simplify the procedure and preserve the thermal bond between the system board and heat sink.

About this task

 **NOTE:** The palm-rest and keyboard assembly cannot be further disassembled once all the pre-removal parts procedures are completed. If the keyboard is malfunctioning and is required to be replaced, replace the entire palm-rest and keyboard assembly.

The image below shows the palm-rest and keyboard assembly after the pre-removal parts procedures have been performed for any palm-rest and keyboard assembly replacement.

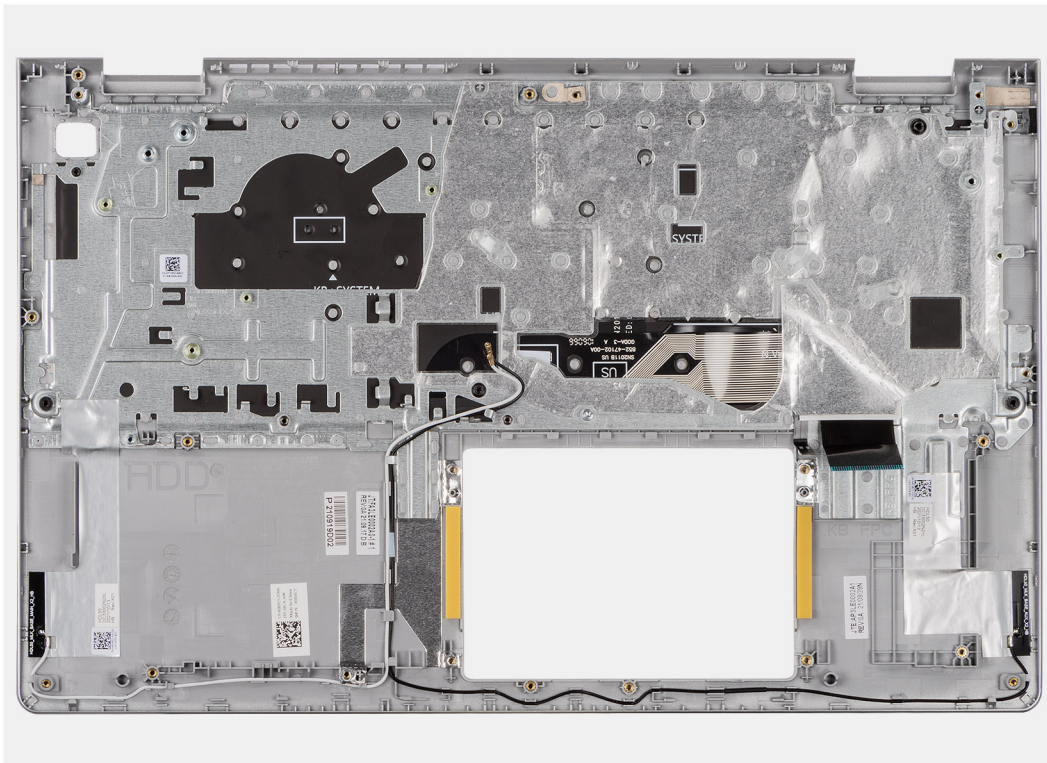

Steps

1. For computers shipped with an aluminum chassis and a 4-cell battery installed, remove the two screws (M2x2) that secure the left RF metal wall bracket to the palm-rest and keyboard assembly.

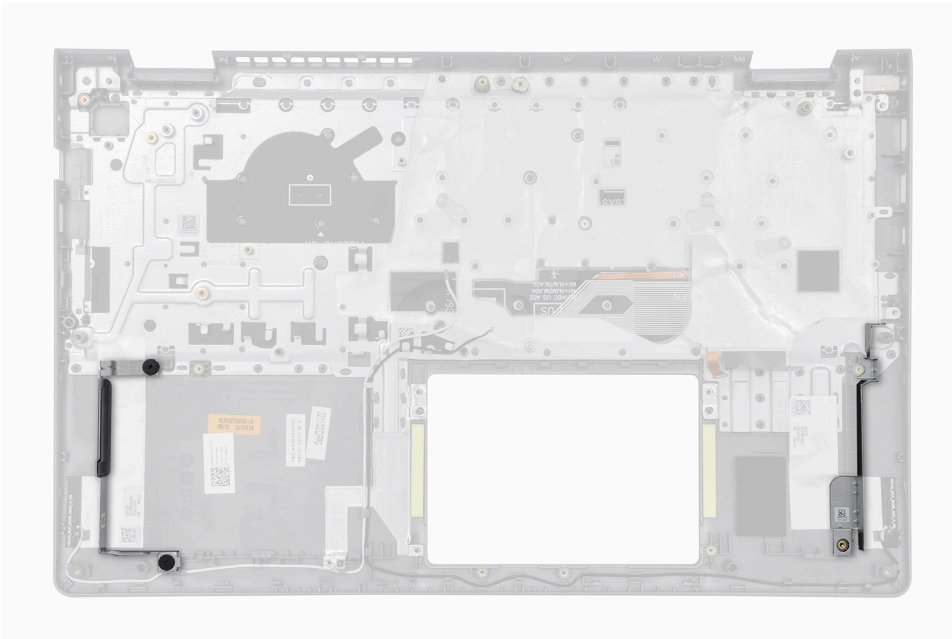

2. For computers shipped with an aluminum chassis, remove the right and left RF metal wall bracket from the palm-rest and keyboard assembly.

i **NOTE:** The left and right RF metal wall brackets **MUST** be transferred to the replacement palm-rest and keyboard assembly.

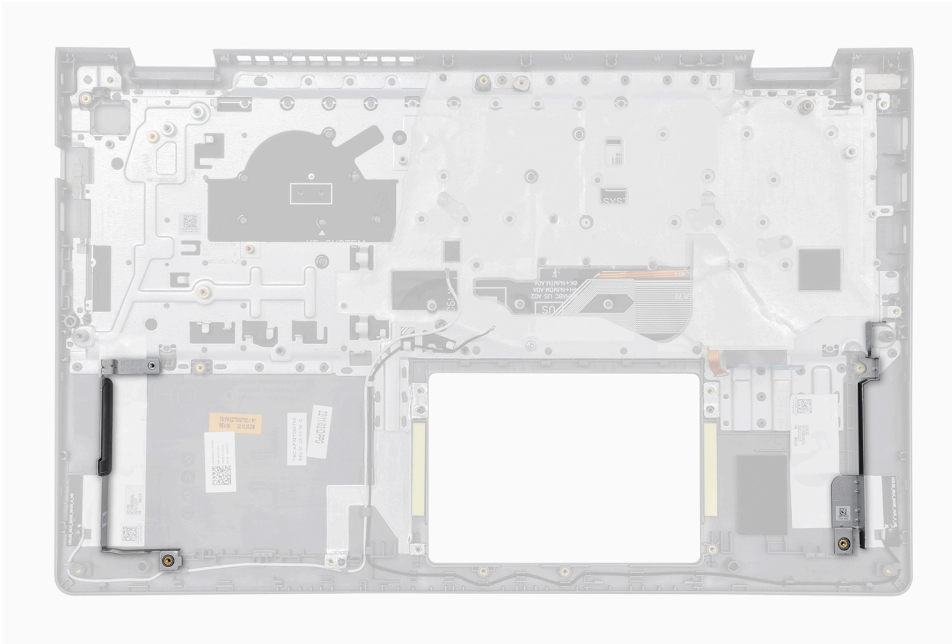

3. After performing the pre-requisites, you are left with the palm-rest and keyboard assembly.

Installing the palm-rest and keyboard assembly

CAUTION: The information in this section is intended for authorized service technicians only.

Prerequisites

If you are replacing a component, remove the existing component before performing the installation procedure.

About this task

NOTE: The system board can be installed with the heat sink attached to it in order to simplify the procedure and preserve the thermal bond between the system board and heat sink.

The following image indicates the location of the palm-rest and keyboard assembly and provides a visual representation of the installation procedure.

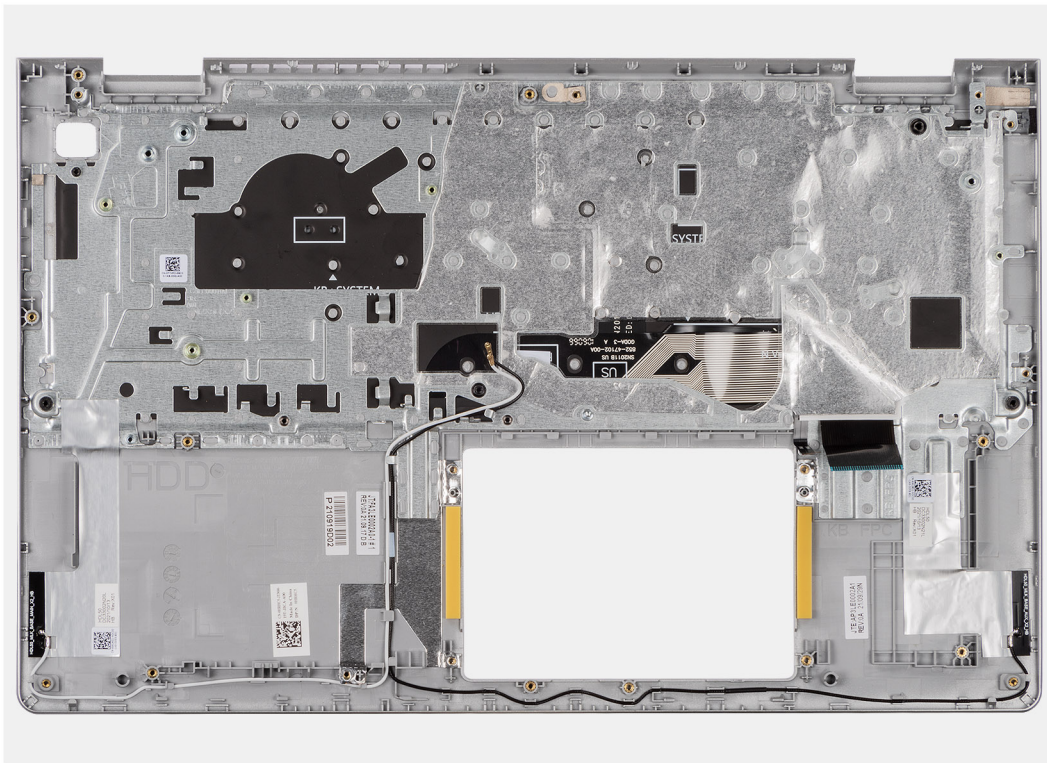

Steps

1. Place the palm-rest and keyboard assembly on a flat surface and perform the post-requisites to install the palm-rest and keyboard assembly.
2. For computers shipped with an aluminum chassis, place the right and left RF metal wall bracket in the slot on the palm-rest and keyboard assembly.

NOTE: The left and right RF metal wall brackets **MUST** be transferred to the replacement palm-rest and keyboard assembly.

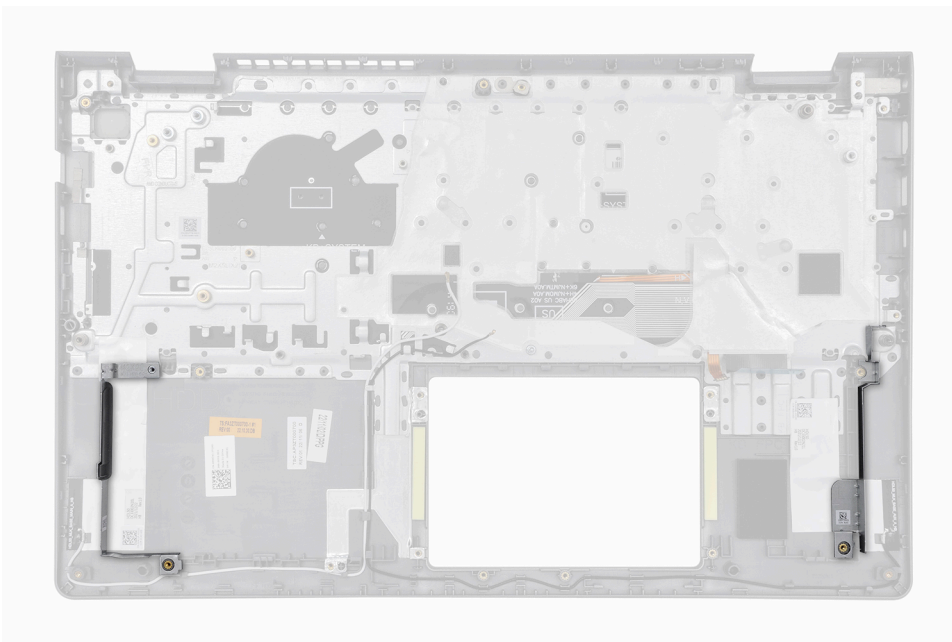

3. For computers shipped with an aluminum chassis and a 4-cell battery installed, replace the two screws (M2x2) to secure the left RF metal wall bracket to the palm-rest and keyboard assembly.

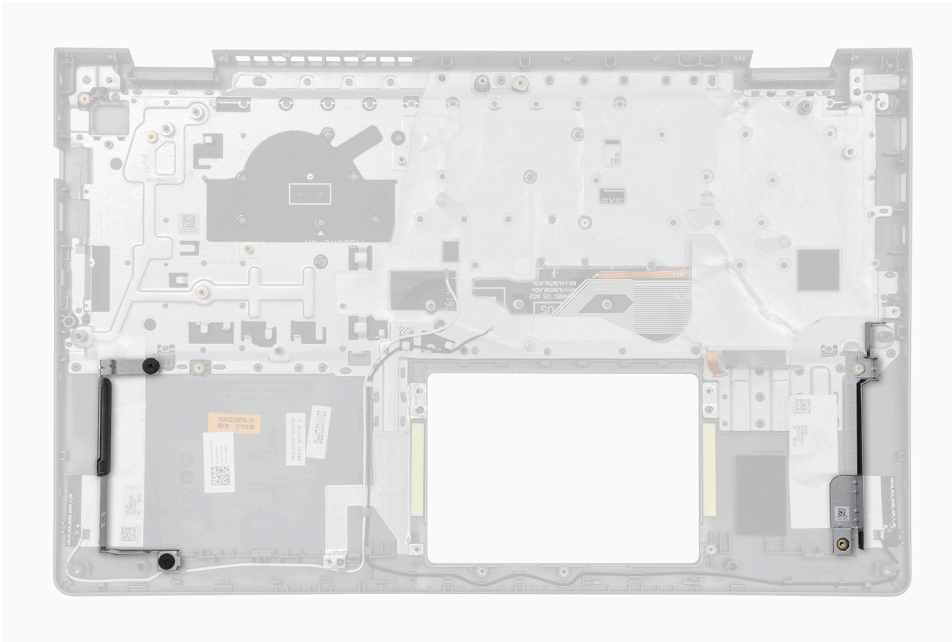

Next steps

1. Install the [system board](#).
2. Install the [display assembly](#).
3. Install the [power-adaptor port](#).
4. Install the [power button](#) or the [power button with optional fingerprint reader](#), whichever applicable.
5. Install the [I/O daughter-board](#).
6. Install the [I/O daughter-board cable](#).
7. Install the [touchpad](#).
8. Install the [3-cell battery](#) or the [4-cell battery](#), whichever applicable.
9. Install the [heat sink - integrated](#) or the [heat sink - discrete](#), whichever applicable.
10. Install the [fan](#).
11. Install the [speakers](#).
12. Install the [wireless card](#).
13. Install the [M.2 2230 solid-state drive](#) or the [M.2 2280 solid-state drive](#), whichever applicable.
14. Install the [memory module](#).
15. Install the [base cover](#).
16. Follow the procedure in [After working inside your computer](#).

Software

This chapter details the supported operating systems along with instructions on how to install the drivers.

Operating system

Your Vostro 15 3530 supports the following operating systems:

- Windows 11 Pro
- Windows 11 Pro National Academic
- Windows 11 Home
- Windows 11 Pro Downgrade (Windows 10 image factory installed)
- Ubuntu 22.04 LTS, 64-bit

Drivers and downloads

When troubleshooting, downloading or installing drivers it is recommended that you read the Dell Knowledge Base article, Drivers and Downloads FAQ [000123347](#).

BIOS setup

CAUTION: Unless you are an expert computer user, do not change the settings in the BIOS Setup program. Certain changes can make your computer work incorrectly.

NOTE: Depending on the computer and its installed devices, the items listed in this section may or may not be displayed.

NOTE: Before you change BIOS Setup program, it is recommended that you write down the BIOS Setup program screen information for future reference.

Use the BIOS Setup program for the following purposes:

- Get information about the hardware installed in your computer, such as the amount of RAM and the size of the hard drive.
- Change the system configuration information.
- Set or change a user-selectable option, such as the user password, type of hard drive installed, and enabling or disabling base devices.

Entering BIOS setup program

About this task

Turn on (or restart) your computer and press F2 immediately.

Navigation keys

NOTE: For most of the System Setup options, changes that you make are recorded but do not take effect until you restart the system.

Table 30. Navigation keys

Keys	Navigation
Up arrow	Moves to the previous field.
Down arrow	Moves to the next field.
Enter	Selects a value in the selected field (if applicable) or follow the link in the field.
Spacebar	Expands or collapses a drop-down list, if applicable.
Tab	Moves to the next focus area. NOTE: For the standard graphics browser only.
Esc	Moves to the previous page until you view the main screen. Pressing Esc in the main screen displays a message that prompts you to save any unsaved changes and restarts the system.

One time boot menu

To enter **one time boot menu**, turn on your computer, and then press F12 immediately.

NOTE: It is recommended to shutdown the computer if it is on.

The one-time boot menu displays the devices that you can boot from including the diagnostic option. The boot menu options are:

- Windows Boot Manager
- UEFI HTTPs Boot
- UEFI M.2 solid-state drive Boot
- ONBOARD NIC (IPV4)
- ONBOARD NIC (IPV6)

The boot sequence screen also displays the option to access the System Setup screen.

System setup options

NOTE: Depending on your computer and its installed devices, the items that are listed in this section may or may not appear.

Table 31. System setup options — System information menu

Overview	
Vostro 15 3530	
BIOS Version	Displays the BIOS version number of the computer.
Service Tag	Displays the Service Tag of the computer.
Asset Tag	Displays the Asset Tag of the computer.
Manufacture Date	Displays the manufacture date of the computer.
Ownership Date	Displays the ownership date of the computer.
Express Service Code	Displays the express service code of the computer.
Ownership Tag	Displays the Ownership Tag of the computer.
Signed Firmware Update	Displays whether the Signed Firmware Update is enabled on your computer. By default, the option is enabled.
Battery	
Primary	Displays that battery is primary.
Battery Level	Displays the battery level of the computer.
Battery State	Displays the battery state of the computer.
Health	Displays the battery health of the computer.
AC Adapter	Displays whether an AC adapter is connected or not. If connected, displays the AC adapter type.
Battery Life Type	Displays the battery life type of the computer.
Processor	
Processor Type	Displays the processor type.
Maximum Clock Speed	Displays the maximum processor clock speed.
Minimum Clock Speed	Displays the minimum processor clock speed.
Current Clock Speed	Displays the current processor clock speed.
Core Count	Displays the number of cores on the processor.
Processor ID	Displays the processor identification code.
Processor L2 Cache	Displays the processor L2 Cache size.
Processor L3 Cache	Displays the processor L3 Cache size.
Microcode Version	Displays the microcode version.

Table 31. System setup options — System information menu (continued)

Overview	
Intel Hyper-Threading Capable	Displays whether the processor is Hyper-Threading (HT) capable or not.
64-Bit Technology	Displays whether 64-bit technology is used or not.
Memory	
Memory Installed	Displays the total computer memory installed.
Memory Available	Displays the total computer memory available.
Memory Speed	Displays the memory speed.
Memory Channel Mode	Displays single or dual channel mode.
Memory Technology	Displays the technology that is used for the memory.
DIMM A Size	Displays the total DIMM A computer memory available, with memory type.
DIMM B Size	Displays the total DIMM B computer memory available, with memory type.
Devices	
Panel Type	Displays the panel type of the computer.
Video Controller	Displays the video controller information of the computer.
Video Memory	Displays the video memory information of the computer.
Wi-Fi Device	Displays the wireless device information of the computer.
Native Resolution	Displays the native resolution of the computer.
Video BIOS Version	Displays the video BIOS version of the computer.
Audio Controller	Displays the audio controller information of the computer.
Bluetooth Device	Displays the Bluetooth device information of the computer.
LOM MAC Address	Displays the MAC address of the computer.

Table 32. System setup options — Boot Configuration menu

Boot Configuration	
Boot Sequence	
Boot mode	Displays the boot mode of the computer.
Boot Sequence	<p>Specifies the order that the BIOS searches the list of devices to find an operating system to boot.</p> <p>By default, the Windows Boot Manager option is selected.</p> <p>By default, the UEFI HTTPs Boot (MAC:04BF1B414407) option is selected.</p> <p>By default, the UEFI RST CL4-3D512-Q11 NVMe SSSTC 512GB VFN39DH002780885 option is selected.</p> <p>By default, the ONBOARD NIC (IPV4) option is selected.</p> <p>By default, the ONBOARD NIC (IPV6) option is selected.</p>
Secure Boot	
Enable Secure Boot	<p>Displays the boot mode of the computer.</p> <p>By default, the option is disabled.</p>
Enable Microsoft UEFI CA	<p>When disabled, the UEFI CA is removed from the BIOS UEFI Secure Boot database.</p> <p>NOTE: When disabled, the Microsoft UEFI CA could render your computer unable to boot, system graphics may not function, some devices may not function properly, and the computer could become unrecoverable.</p> <p>By default, the option is enabled.</p>

Table 32. System setup options — Boot Configuration menu (continued)

Boot Configuration	
Secure Boot Mode	Enables or disables the Secure Boot operation mode. By default, the Deployed Mode option is selected.
Expert Key Management	
Enable Custom Mode	Enables or disables the keys in the PK, KEK, db, and dbx security key databases to be modified. By default, the option is disabled.
Custom Mode Key Management	Allows the user to select the custom values for expert key management. By default, PK option is selected.

Table 33. System setup options — Integrated Devices menu

Integrated Devices	
Date/Time	
Date	Sets the computer date in MM/DD/YYYY format. Changes to the date take effect immediately.
Time	Sets the computer time in HH:MM:SS 24-hour format. You can switch between 12-hour and 24-hour clock. Changes to the time take effect immediately.
Camera	
Enable Camera	Enables or disables the camera. By default, the option is enabled.
Audio	
	Enables or disables the integrated audio controller. By default, all the options are enabled.
Enable Microphone	Enables or disables the microphone. By default, the option is enabled.
Enable Internal Speaker	Enables or disables the internal speaker. By default, the option is enabled.
USB Configuration	
Enable USB Boot Support	Enables or disables the USB boot support. When enabled, bootable USB mass storage devices (such as HDD, flash drive, CD/DVD) can boot through the boot sequence or boot menu. USB ports are also functional in an OS environment. When disabled, bootable USB mass storage devices are prevented from booting through the boot sequence or boot menu but the USB ports are functional in an OS environment. By default, the option is enabled.

Table 34. System setup options — Storage menu

Storage	
SATA/NVMe Operation	
	Allows the user to set the operating mode of the integrated storage device controller. By default, RAID On option is selected.
Storage interface	
Port Enablement	Enables or disables the onboard drives.

Table 34. System setup options — Storage menu (continued)

Storage	
	By default, the SATA-0 option is enabled.
	By default, the M.2 PCIe SSD option is enabled.
Drive Information	
SATA-0	
Type	Displays the SATA-0 type information of the computer.
Device	Displays the SATA-0 device information of the computer.
M.2 PCIe SSD	
Type	Displays the M.2 PCIe SSD type information of the computer.
Device	Displays the M.2 PCIe SSD device information of the computer.

Table 35. System setup options — Display menu

Display	
Display Brightness	
Brightness on battery power	Allows the user to set the screen brightness level when the computer is running on battery power. By default, the Brightness on battery power level is set to 70.
Brightness on AC power	Allows the user to set the screen brightness level when the computer is running on AC power. By default, the Brightness on AC power level is set to 100.

Table 36. System setup options — Security menu

Security	
TPM 2.0 Security	
Clear	When enabled, the Clear option clears information stored in the TPM after exiting the system's BIOS. This option returns to disabled state when the system restarts. By default, the option is disabled.
PPI Bypass for Clear Commands	Enables or disables the TPM Physical Presence Interface (PPI). When enabled, this setting allows the operating system to skip BIOS PPI user prompts when issuing the Clear command. Changes to this setting take effect immediately. By default, the option is disabled.
Data Wipe on Next Boot	
Start Data Wipe	Enables or disables the Data Wipe feature. When enabled, the BIOS will queue up a data wipe cycle for storage device(s), connected to the computer, on next reboot.  WARNING: Secure Data Wipe operation deletes information in a way that it cannot be reconstructed. By default, the option is disabled.

Table 37. System setup options — Passwords menu

Passwords	
Admin Password	Enables the user to set, change, or delete the administrator (admin) password. The administrator password enables several security features.
System Password	Enables the user to set, change, or delete the system password. The system password prevents the computer from booting to an operating system without entering the correct password.
M.2 PCIe SSD-0	Enables the user to set, change, or delete the M.2 PCIe SSD-0 password.

Table 38. System setup options — Update, Recovery menu

Update, Recovery	
SupportAssist OS Recovery	Enables or disables the boot flow for SupportAssist OS Recovery tool, in the event of certain system error. By default, the option is enabled.
BIOSConnect	Enables or disables cloud Service OS recovery if the main OS fails to boot within the number of failures equal or greater than the value specified by Dell Auto OS Recovery Threshold, and local Service does not boot, or is not installed. By default, the option is enabled.
Dell Auto OS Recovery Threshold	Controls the automatic boot flow for SupportAssist System Resolution Console and for Dell operating system Recovery tool. By default, the Dell Auto OS Recovery Threshold value is set to 2.

Table 39. System setup options — System Management menu

System Management	
Service Tag	Displays the Service Tag of the computer.
Asset Tag	Creates a system Asset Tag that can be used by an IT administrator to uniquely identify a particular system. Once set in BIOS, the Asset Tag cannot be changed.
Diagnostics	
OS Agent Requests	Enables or disables the Dell OS Agent to schedule onboard diagnostics on a subsequent boot. Enabling this option helps assist in prevention and resolution of hardware related issues. By default, the option is enabled.

Table 40. System setup options — Keyboard menu

Keyboard	
Keyboard illumination	Allows the user to select the keyboard illumination brightness. By default, the Dim option is selected. This option enables the keyboard illumination feature at 50% brightness level.
Keyboard Backlight Timeout on AC	Allows the user to set the keyboard backlight timeout duration when the computer is running on AC power. The keyboard backlight timeout value is only in effect when the backlight is enabled. By default, the Keyboard Backlight Timeout on AC value is set to 1 minute.
Keyboard Backlight Timeout on battery	Allows the user to set the keyboard backlight timeout duration when the computer is running on battery power. The keyboard backlight timeout value is only in effect when the backlight is enabled.

Table 40. System setup options — Keyboard menu (continued)

Keyboard	
	By default, the Keyboard Backlight Timeout on battery value is set to 1 minute.

Table 41. System setup options — Pre-boot Behavior menu

Pre-boot Behavior	
Adapter Warnings	
Enable Adapter Warnings	Enables or disables the computer to display adapter warning messages when adapters with too little power capacity are detected. By default, the option is enabled.
Warning and Errors	
	Enables or disables the action to be taken when a warning or error is encountered. By default, the Prompt on Warnings and Errors option is enabled. It stops, prompts, and waits for user input when warnings or errors are detected.
	NOTE: Errors deemed critical to the operation of the computer hardware will always halt the computer.

Table 42. System setup options — System Logs menu

System Logs	
BIOS Event Log	
Clear Bios Event Log	Displays BIOS events. By default, the Keep Log option is selected.
Thermal Event Log	
Clear Thermal Event Log	Displays Thermal events. By default, the Keep Log option is selected.
Power Event Log	
Clear Power Event Log	Displays power events. By default, the Keep Log option is selected.

Updating the BIOS

Updating the BIOS in Windows

About this task

CAUTION: If BitLocker is not suspended before updating the BIOS, the next time you reboot the system it will not recognize the BitLocker key. You will then be prompted to enter the recovery key to progress and the system will ask for this on each reboot. If the recovery key is not known this can result in data loss or an unnecessary operating system re-install. For more information on this subject, search in the Knowledge Base Resource at www.dell.com/support.

Steps

1. Go to www.dell.com/support.
2. Click **Product support**. In the **Search support** box, enter the Service Tag of your computer, and then click **Search**.

 **NOTE:** If you do not have the Service Tag, use the SupportAssist feature to automatically identify your computer. You can also use the product ID or manually browse for your computer model.

3. Click **Drivers & Downloads**. Expand **Find drivers**.
4. Select the operating system installed on your computer.
5. In the **Category** drop-down list, select **BIOS**.
6. Select the latest version of BIOS, and click **Download** to download the BIOS file for your computer.
7. After the download is complete, browse the folder where you saved the BIOS update file.
8. Double-click the BIOS update file icon and follow the on-screen instructions.

For more information, search in the Knowledge Base Resource at www.dell.com/support.

Updating the BIOS in Linux and Ubuntu

To update the system BIOS on a computer that is installed with Linux or Ubuntu, see the knowledge base article [000131486](https://www.dell.com/support) at www.dell.com/support.

Updating the BIOS using the USB drive in Windows

About this task

 **CAUTION:** If BitLocker is not suspended before updating the BIOS, the next time you reboot the system it will not recognize the BitLocker key. You will then be prompted to enter the recovery key to progress and the system will ask for this on each reboot. If the recovery key is not known this can result in data loss or an unnecessary operating system re-install. For more information on this subject, search in the Knowledge Base Resource at www.dell.com/support.

Steps

1. Follow the procedure from step 1 to step 6 in [Updating the BIOS in Windows](#) to download the latest BIOS setup program file.
2. Create a bootable USB drive. For more information, search in the Knowledge Base Resource at www.dell.com/support.
3. Copy the BIOS setup program file to the bootable USB drive.
4. Connect the bootable USB drive to the computer that needs the BIOS update.
5. Restart the computer and press **F12**.
6. Select the USB drive from the **One Time Boot Menu**.
7. Type the BIOS setup program filename and press **Enter**.
The **BIOS Update Utility** appears.
8. Follow the on-screen instructions to complete the BIOS update.

Updating the BIOS from the F12 One-Time boot menu

Update your computer BIOS using the BIOS update.exe file that is copied to a FAT32 USB drive and booting from the F12 One-Time boot menu.

About this task

 **CAUTION:** If BitLocker is not suspended before updating the BIOS, the next time you reboot the system it will not recognize the BitLocker key. You will then be prompted to enter the recovery key to progress and the system will ask for this on each reboot. If the recovery key is not known this can result in data loss or an unnecessary operating system re-install. For more information on this subject, search in the Knowledge Base Resource at www.dell.com/support.

BIOS Update

You can run the BIOS update file from Windows using a bootable USB drive or you can also update the BIOS from the F12 One-Time boot menu on the computer.

Most of the Dell computers built after 2012 have this capability, and you can confirm by booting your computer to the F12 One-Time Boot Menu to see if BIOS FLASH UPDATE is listed as a boot option for your computer. If the option is listed, then the BIOS supports this BIOS update option.

 **NOTE:** Only computers with BIOS Flash Update option in the F12 One-Time boot menu can use this function.

Updating from the One-Time boot menu

To update your BIOS from the F12 One-Time boot menu, you need the following:

- USB drive formatted to the FAT32 file system (key does not have to be bootable)
- BIOS executable file that you downloaded from the Dell Support website and copied to the root of the USB drive
- AC power adapter that is connected to the computer
- Functional computer battery to flash the BIOS

Perform the following steps to perform the BIOS update flash process from the F12 menu:

 **CAUTION:** Do not turn off the computer during the BIOS update process. The computer may not boot if you turn off your computer.

Steps

1. From a turn off state, insert the USB drive where you copied the flash into a USB port of the computer.
2. Turn on the computer and press F12 to access the One-Time Boot Menu, select BIOS Update using the mouse or arrow keys then press Enter.
The flash BIOS menu is displayed.
3. Click **Flash from file**.
4. Select external USB device.
5. Select the file and double-click the flash target file, and then click **Submit**.
6. Click **Update BIOS**. The computer restarts to flash the BIOS.
7. The computer will restart after the BIOS update is completed.

System and setup password

Table 43. System and setup password

Password type	Description
System password	Password that you must enter to log in to your system.
Setup password	Password that you must enter to access and make changes to the BIOS settings of your computer.

You can create a system password and a setup password to secure your computer.

 **CAUTION:** The password features provide a basic level of security for the data on your computer.

 **CAUTION:** Anyone can access the data that is stored on your computer if it is not locked and left unattended.

 **NOTE:** System and setup password feature is disabled.

Assigning a system setup password

Prerequisites

You can assign a new **System or Admin Password** only when the status is in **Not Set**.

About this task

To enter the system setup, press F12 immediately after a power-on or reboot.

Steps

1. In the **System BIOS** or **System Setup** screen, select **Security** and press Enter.
The **Security** screen is displayed.
2. Select **System/Admin Password** and create a password in the **Enter the new password** field.
Use the following guidelines to assign the system password:
 - A password can have up to 32 characters.
 - At least one special character: ! " # \$ % & ' () * + , - . / : ; < = > ? @ [\] ^ _ ` { | }
 - Numbers 0 through 9.
 - Upper case letters from A to Z.
 - Lower case letters from a to z.
3. Type the system password that you entered earlier in the **Confirm new password** field and click **OK**.
4. Press Esc and save the changes as prompted by the pop-up message.
5. Press Y to save the changes.
The computer restarts.

Deleting or changing an existing system setup password

Prerequisites

Ensure that the **Password Status** is Unlocked (in the System Setup) before attempting to delete or change the existing System and/or Setup password. You cannot delete or change an existing System or Setup password, if the **Password Status** is Locked.

About this task

To enter the System Setup, press F12 immediately after a power-on or reboot.

Steps

1. In the **System BIOS** or **System Setup** screen, select **System Security** and press Enter.
The **System Security** screen is displayed.
2. In the **System Security** screen, verify that **Password Status** is **Unlocked**.
3. Select **System Password**, update, or delete the existing system password, and press Enter or Tab.
4. Select **Setup Password**, update, or delete the existing setup password, and press Enter or Tab.
 **NOTE:** If you change the System and/or Setup password, reenter the new password when prompted. If you delete the System and/or Setup password, confirm the deletion when prompted.
5. Press Esc and a message prompts you to save the changes.
6. Press Y to save the changes and exit from System Setup.
The computer restarts.

Clearing BIOS (System Setup) and System passwords

About this task

To clear the system or BIOS passwords, contact Dell technical support as described at www.dell.com/contactdell.

-  **NOTE:** For information on how to reset Windows or application passwords, refer to the documentation accompanying Windows or your application.

Troubleshooting

Handling swollen Lithium-ion batteries

Like most laptops, Dell laptops use lithium-ion batteries. One type of lithium-ion battery is the lithium-ion polymer battery. Lithium-ion polymer batteries have increased in popularity in recent years and have become standard in the electronics industry due to customer preferences for a slim form factor (especially with newer ultra-thin laptops) and long battery life. Inherent to lithium-ion polymer battery technology is the potential for swelling of the battery cells.

Swollen battery may impact the performance of the laptop. To prevent possible further damage to the device enclosure or internal components leading to malfunction, discontinue the use of the laptop and discharge it by disconnecting the AC adapter and letting the battery drain.

Swollen batteries should not be used and should be replaced and disposed of properly. We recommend contacting Dell product support for options to replace a swollen battery under the terms of the applicable warranty or service contract, including options for replacement by a Dell authorized service technician.

The guidelines for handling and replacing Lithium-ion batteries are as follows:

- Exercise caution when handling Lithium-ion batteries.
- Discharge the battery before removing it from the system. To discharge the battery, unplug the AC adapter from the system and operate the system only on battery power. When the system will no longer power on when the power button is pressed, the battery is fully discharged.
- Do not crush, drop, mutilate, or penetrate the battery with foreign objects.
- Do not expose the battery to high temperatures, or disassemble battery packs and cells.
- Do not apply pressure to the surface of the battery.
- Do not bend the battery.
- Do not use tools of any type to pry on or against the battery.
- If a battery gets stuck in a device as a result of swelling, do not try to free it as puncturing, bending, or crushing a battery can be dangerous.
- Do not attempt to reassemble a damaged or swollen battery into a laptop.
- Swollen batteries that are covered under warranty should be returned to Dell in an approved shipping container (provided by Dell)—this is to comply with transportation regulations. Swollen batteries that are not covered under warranty should be disposed of at an approved recycling center. Contact Dell product support at <https://www.dell.com/support> for assistance and further instructions.
- Using a non-Dell or incompatible battery may increase the risk of fire or explosion. Replace the battery only with a compatible battery purchased from Dell that is designed to work with your Dell computer. Do not use a battery from other computers with your computer. Always purchase genuine batteries from <https://www.dell.com> or otherwise directly from Dell.

Lithium-ion batteries can swell for various reasons such as age, number of charge cycles, or exposure to high heat. For more information on how to improve the performance and lifespan of the laptop battery and to minimize the possibility of occurrence of the issue, search Dell Laptop Battery in the Knowledge Base Resource at www.dell.com/support.

Locate the Service Tag or Express Service Code of your Dell computer

Your Dell computer is uniquely identified by a Service Tag or Express Service Code. To view relevant support resources for your Dell computer, we recommend entering the Service Tag or Express Service Code at www.dell.com/support.

For more information on how to find the Service Tag for your computer, see [Locate the Service Tag for your Dell Laptop](#).

Dell SupportAssist Pre-boot System Performance Check diagnostics

About this task

SupportAssist diagnostics (also known as system diagnostics) performs a complete check of your hardware. The Dell SupportAssist Pre-boot System Performance Check diagnostics is embedded with the BIOS and is launched by the BIOS internally. The embedded system diagnostics provides a set of options for particular devices or device groups allowing you to:

- Run tests automatically or in an interactive mode
- Repeat tests
- Display or save test results
- Run thorough tests to introduce additional test options to provide extra information about the failed device(s)
- View status messages that inform you if tests are completed successfully
- View error messages that inform you of problems encountered during testing

 **NOTE:** Some tests for specific devices require user interaction. Always ensure that you are present at the computer terminal when the diagnostic tests are performed.

For more information, see [Resolve Hardware Issues With Integrated and Online Diagnostics \(SupportAssist ePSA, ePSA, or PSA Error Codes\)](#).

Running the SupportAssist Pre-Boot System Performance Check

Steps

1. Turn on your computer.
2. As the computer boots, press the F12 key as the Dell logo appears.
3. On the boot menu screen, select the **Diagnostics** option.
4. Click the arrow at the bottom left corner.
Diagnostics front page is displayed.
5. Click the arrow in the lower-right corner to go to the page listing.
The items detected are listed.
6. To run a diagnostic test on a specific device, press Esc and click **Yes** to stop the diagnostic test.
7. Select the device from the left pane and click **Run Tests**.
8. If there are any issues, error codes are displayed.
Note the error code and validation number and contact Dell.

Built-in self-test (BIST)

M-BIST

M-BIST (Built In Self-Test) is the system board's built-in self-test diagnostics tool that improves the diagnostics accuracy of system board embedded controller (EC) failures.

 **NOTE:** M-BIST can be manually initiated before POST (Power On Self Test).

How to run M-BIST

 **NOTE:** M-BIST must be initiated on the system from a power-off state either connected to AC power or with battery only.

1. Press and hold both the **M** key on the keyboard and the **power button** to initiate M-BIST.
2. With both the **M** key and the **power button** held down, the battery indicator LED may exhibit two states:
 - a. OFF: No fault detected with the system board
 - b. AMBER: Indicates a problem with the system board

- If there is a failure with the system board, the battery status LED will flash one of the following error codes for 30 seconds:

Table 44. LED error codes

Blinking Pattern		Possible Problem
Amber	White	
2	1	CPU Failure
2	8	LCD Power Rail Failure
1	1	TPM Detection Failure
2	4	Memory/RAM failure

- If there is no failure with the system board, the LCD will cycle through the solid color screens described in the LCD-BIST section for 30 seconds and then power off.

LCD Power rail test (L-BIST)

L-BIST is an enhancement to the single LED error code diagnostics and is automatically initiated during POST. L-BIST will check the LCD power rail. If there is no power being supplied to the LCD (that is if the L-BIST circuit fails), the battery status LED will flash either an error code [2,8] or an error code [2,7].

NOTE: If L-BIST fails, LCD-BIST cannot function as no power will be supplied to the LCD.

How to invoke L-BIST Test:

- Press the power button to start the system.
- If the system does not start up normally, look at the battery status LED:
 - If the battery status LED flashes an error code [2,7], the display cable may not be connected properly.
 - If the battery status LED flashes an error code [2,8], there is a failure on the LCD power rail of the system board, hence there is no power supplied to the LCD.
- For cases, when a [2,7] error code is shown, check to see if the display cable is properly connected.
- For cases when a [2,8] error code is shown, replace the system board.

LCD Built-in Self Test (BIST)

Dell laptops have a built-in diagnostic tool that helps you determine if the screen abnormality you are experiencing is an inherent problem with the LCD (screen) of the Dell laptop or with the video card (GPU) and PC settings.

When you notice screen abnormalities like flickering, distortion, clarity issues, fuzzy or blurry image, horizontal or vertical lines, color fade etc., it is always a good practice to isolate the LCD (screen) by running the Built-In Self Test (BIST).

How to invoke LCD BIST Test

- Power off the Dell laptop.
- Disconnect any peripherals that are connected to the laptop. Connect only the AC adapter (charger) to the laptop.
- Ensure that the LCD (screen) is clean (no dust particles on the surface of the screen).
- Press and hold **D** key and **Power on** the laptop to enter LCD built-in self test (BIST) mode. Continue to hold the D key, until the system boots up.
- The screen will display solid colors and change colors on the entire screen to white, black, red, green, and blue twice.
- Then it will display the colors white, black and red.
- Carefully inspect the screen for abnormalities (any lines, fuzzy color or distortion on the screen).
- At the end of the last solid color (red), the system will shut down.

NOTE: Dell SupportAssist Pre-boot diagnostics upon launch, initiates an LCD BIST first, expecting a user intervention confirm functionality of the LCD.

System-diagnostic lights

Power and battery-status light

The power and battery status light indicates the power and battery status of the computer. These are the power states:

Solid white: Power adapter is connected and the battery has more than 5% charge.

Amber: Computer is running on battery and the battery has less than 5% charge.

Off:

- Power adapter is connected, and the battery is fully charged.
- Computer is running on battery, and the battery has more than 5% charge.
- Computer is in sleep state, hibernation, or turned off.

The power and battery-status light may blink amber or white according to pre-defined "beep codes" indicating various failures.

For example, the power and battery-status light blinks amber two times followed by a pause, and then blinks white three times followed by a pause. This 2,3 pattern continues until the computer is turned off, indicating no memory or RAM is detected.

The following table shows different power and battery-status light patterns and associated problems.

i NOTE: The following diagnostic light codes and recommended solutions are intended for Dell service technicians to troubleshoot problems. You should only perform troubleshooting and repairs as authorized or directed by the Dell technical assistance team. Damage due to servicing that is not authorized by Dell is not covered by your warranty.

Table 45. Diagnostic-light LED codes

Blinking pattern		Problem description	Suggested resolution
Amber	White		
2	1	CPU failure	Replace the system board.
2	2	System board failure (included BIOS corruption or ROM error)	<ul style="list-style-type: none"> • Flash latest BIOS version. • If problem persists, replace the system board.
2	3	No memory/RAM detected	<ul style="list-style-type: none"> • Confirm that the memory module is installed properly. • If problem persists, replace the memory module.
2	4	Memory/RAM failure	Replace the memory module.
2	5	Invalid memory installed	Replace the memory module.
2	6	System board/chipset error	Replace the system board.
2	7	LCD failure	Replace the LCD module.
2	8	LCD power rail failure	Replace the LCD module.
3	1	RTC power failure	Replace the battery.
3	2	PCI or video card/chip failure	Replace the system board.
3	3	BIOS Recovery image not found	<ul style="list-style-type: none"> • Flash latest BIOS version. • If problem persists, replace the system board.
3	4	BIOS Recovery image found but invalid	<ul style="list-style-type: none"> • Flash latest BIOS version.

Table 45. Diagnostic-light LED codes (continued)

Blinking pattern		Problem description	Suggested resolution
Amber	White		
			<ul style="list-style-type: none"> If problem persists, replace the system board.
3	5	Power rail failure	<ul style="list-style-type: none"> Flash latest BIOS version. If problem persists, replace the system board.
3	6	SBIOS flash corruption	<ul style="list-style-type: none"> Flash latest BIOS version. If problem persists, replace the system board.
3	7	ME error	<ul style="list-style-type: none"> Flash latest BIOS version. If problem persists, replace the system board.

NOTE: Blinking 3-3-3 LEDs on Lock LED (Caps-Lock or Nums-Lock), Power button LED (without Fingerprint reader), and Diagnostic LED indicates failure to provide input during LCD panel test on Dell SupportAssist Pre-boot System Performance Check diagnostics.

Camera status light: Indicates whether the camera is in use.

- Solid white—Camera is in use.
- Off—Camera is not in use.

Caps Lock status light: Indicates whether Caps Lock is enabled or disabled.

- Solid white — Caps Lock enabled.
- Off — Caps Lock disabled.

Recovering the operating system

When your computer is unable to boot to the operating system even after repeated attempts, it automatically starts Dell SupportAssist OS Recovery.

Dell SupportAssist OS Recovery is a standalone tool that is preinstalled in all Dell computers installed with Windows operating system. It consists of tools to diagnose and troubleshoot issues that may occur before your computer boots to the operating system. It enables you to diagnose hardware issues, repair your computer, back up your files, or restore your computer to its factory state.

You can also download it from the Dell Support website to troubleshoot and fix your computer when it fails to boot into their primary operating system due to software or hardware failures.

For more information about the Dell SupportAssist OS Recovery, see *Dell SupportAssist OS Recovery User's Guide* at www.dell.com/serviceabilitytools. Click **SupportAssist** and then, click **SupportAssist OS Recovery**.

Real-Time Clock (RTC Reset)

The Real Time Clock (RTC) reset function allows you or the service technician to recover Dell systems from No POST/No Power/No Boot situations. The legacy jumper enabled RTC reset has been retired on these models.

Start the RTC reset with the system powered off and connected to AC power. Press and hold the power button for twenty (20) seconds . The system RTC Reset occurs after you release the power button.

Backup media and recovery options

It is recommended to create a recovery drive to troubleshoot and fix problems that may occur with Windows. Dell proposes multiple options for recovering Windows operating system on your Dell PC. For more information, see [Dell Windows Backup Media and Recovery Options](#).

Wi-Fi power cycle

About this task

If your computer is unable to access the Internet due to Wi-Fi connectivity issues a Wi-Fi power cycle procedure may be performed. The following procedure provides the instructions on how to conduct a Wi-Fi power cycle:

 **NOTE:** Some ISPs (Internet Service Providers) provide a modem/router combo device.

Steps

1. Turn off your computer.
2. Turn off the modem.
3. Turn off the wireless router.
4. Wait for 30 seconds.
5. Turn on the wireless router.
6. Turn on the modem.
7. Turn on your computer.

Drain residual flea power (perform hard reset)

About this task

Flea power is the residual static electricity that remains in the computer even after it has been powered off and the battery is removed.

For your safety, and to protect the sensitive electronic components in your computer, you are requested to drain residual flea power before removing or replacing any components in your computer.

Draining residual flea power, also known as a performing a "hard reset", is also a common troubleshooting step if your computer does not power on or boot into the operating system.

To drain residual flea power (perform a hard reset)

Steps

1. Turn off your computer.
2. Disconnect the power adapter from your computer.
3. Remove the base cover.
4. Remove the battery.
5. Press and hold the power button for 20 seconds to drain the flea power.
6. Install the battery.
7. Install the base cover.
8. Connect the power adapter to your computer.
9. Turn on your computer.



 **NOTE:** For more information about performing a hard reset, search in the Knowledge Base Resource at www.dell.com/support.

Getting help and contacting Dell

Self-help resources

You can get information and help on Dell products and services using these self-help resources:

Table 46. Self-help resources

Self-help resources	Resource location
Information about Dell products and services	www.dell.com
My Dell app	
Tips	
Contact Support	In Windows search, type <code>Contact Support</code> , and press Enter.
Online help for operating system	www.dell.com/support/windows www.dell.com/support/linux
Access top solutions, diagnostics, drivers and downloads, and learn more about your computer through videos, manuals and documents.	Your Dell computer is uniquely identified by a Service Tag or Express Service Code. To view relevant support resources for your Dell computer, enter the Service Tag or Express Service Code at www.dell.com/support . For more information on how to find the Service Tag for your computer, see Locate the Service Tag on your computer .
Dell knowledge base articles for a variety of computer concerns	<ol style="list-style-type: none"> 1. Go to www.dell.com/support. 2. On the menu bar at the top of the Support page, select Support > Knowledge Base. 3. In the Search field on the Knowledge Base page, type the keyword, topic, or model number, and then click or tap the search icon to view the related articles.

Contacting Dell

To contact Dell for sales, technical support, or customer service issues, see www.dell.com/contactdell.

 **NOTE:** Availability varies by country/region and product, and some services may not be available in your country/region.

 **NOTE:** If you do not have an active Internet connection, you can find contact information about your purchase invoice, packing slip, bill, or Dell product catalog.