

# Dell PowerEdge R360

## Installation and Service Manual

## Notes, cautions, and warnings

 **NOTE:** A NOTE indicates important information that helps you make better use of your product.

 **CAUTION:** A CAUTION indicates either potential damage to hardware or loss of data and tells you how to avoid the problem.

 **WARNING:** A WARNING indicates a potential for property damage, personal injury, or death.



<b>Chapter 1: About this document</b> .....	<b>7</b>
<b>Chapter 2: PowerEdge R360 system overview</b> .....	<b>8</b>
Front view of the system.....	8
Rear view of the system.....	9
Inside the system.....	11
Locating the Express Service Code and Service Tag.....	12
System information labels.....	12
Rail sizing and rack compatibility matrix.....	16
<b>Chapter 3: Technical specifications</b> .....	<b>17</b>
Chassis dimensions .....	18
System weight.....	18
Processor specifications.....	19
PSU specifications.....	19
Cooling fan specifications.....	20
Supported operating systems.....	21
System battery specifications.....	21
Expansion card riser specifications.....	21
Memory specifications.....	21
Storage controller specifications.....	22
Drives.....	22
GPU specifications.....	22
Ports and connectors specifications.....	22
NIC port specifications.....	22
Serial connector specifications.....	23
USB ports specifications.....	23
VGA ports specifications.....	23
Video specifications.....	23
Environmental specifications.....	24
Thermal air restrictions.....	25
Thermal restriction matrix.....	26
<b>Chapter 4: Initial system setup and configuration</b> .....	<b>28</b>
Setting up the system.....	28
iDRAC configuration.....	28
Options to set up iDRAC IP address.....	28
Options to log in to iDRAC.....	28
Resources to install operating system.....	29
Options to download drivers and firmware .....	29
Options to download and install OS drivers .....	30
Downloading drivers and firmware.....	30
<b>Chapter 5: Pre-operating system management applications</b> .....	<b>31</b>

System Setup.....	31
System Information.....	32
Memory Settings.....	32
Processor Settings.....	33
SATA Settings.....	33
Boot Settings.....	34
Network Settings.....	35
Integrated Devices.....	36
Serial Communication.....	38
System Profile Settings.....	39
System Security.....	39
Redundant OS Control.....	44
Miscellaneous Settings.....	44
Dell Lifecycle Controller.....	45
Embedded system management.....	45
Boot Manager.....	45
PXE boot.....	45
<b>Chapter 6: Minimum to POST .....</b>	<b>46</b>
Minimum configuration to POST .....	46
Configuration validation.....	46
Error messages.....	47
<b>Chapter 7: Installing and removing system components .....</b>	<b>48</b>
Safety instructions.....	48
Before working inside your system .....	48
After working inside your system.....	48
Recommended tools.....	49
Optional front bezel.....	49
Removing the front bezel.....	49
Installing the front bezel.....	50
System cover.....	51
Removing the system cover.....	51
Installing the system cover.....	52
Air shroud.....	54
Removing the air shroud.....	54
Installing the air shroud.....	54
Cooling fans.....	55
Removing the cooling fan.....	55
Installing a cooling fan.....	56
Intrusion switch.....	57
Removing the intrusion switch.....	57
Installing the intrusion switch.....	58
Drive backplane.....	59
Drive backplane guidelines.....	59
Removing the front drive bay backplane.....	60
Installing the front drive bay backplane.....	61
Cable routing.....	62
Drives.....	66

Removing a drive blank.....	66
Installing a drive blank.....	67
Removing a drive carrier.....	68
Removing the drive from the drive carrier.....	68
Installing a drive into the drive carrier.....	69
Installing a drive carrier.....	70
Removing a 2.5-inch drive from a 3.5-inch drive adapter.....	71
Installing a 2.5-inch drive into a 3.5-inch drive adapter.....	72
System memory.....	73
System memory guidelines.....	73
General memory module installation guidelines.....	75
Removing a memory module.....	75
Installing a memory module.....	76
Processor and heat sink module.....	77
Removing the heat sink module.....	77
Removing the processor.....	78
Installing the processor.....	79
Installing the processor and heat sink module.....	80
Expansion cards and expansion card risers .....	82
Expansion card installation guidelines.....	82
Removing an expansion card from the riser.....	83
Installing the expansion card in to the expansion card riser.....	84
Removing an expansion card riser.....	86
Installing an expansion card riser.....	86
Optional BOSS-N1 module.....	87
Removing the BOSS N1 module.....	87
Installing the BOSS N1 module.....	89
Removing the BOSS N1 blank.....	91
Installing the BOSS N1 blank.....	92
System battery .....	93
Replacing the system battery.....	93
PERC card.....	95
Removing the internal PERC card.....	95
Installing the internal PERC card.....	95
Removing the front mounting front PERC riser and front PERC module.....	96
Installing the front mounting front PERC riser and front PERC module.....	98
Power supply units.....	99
Hot spare feature.....	99
Removing a power supply unit blank.....	99
Installing a power supply unit blank.....	100
Removing a power supply unit.....	101
Installing a power supply unit.....	101
Power interposer board (PIB).....	102
Removing the PIB.....	102
Installing the PIB.....	103
System board.....	104
Removing the system board.....	104
Installing the system board.....	105
Restoring the system using Easy Restore.....	106
Manually update the Service Tag.....	107

Trusted Platform Module.....	107
Upgrading the Trusted Platform Module.....	107
Initializing TPM for users.....	108
Initializing the TPM 2.0 for users.....	108
Control panel.....	109
Removing the right control panel.....	109
Installing the right control panel.....	110
Removing the left control panel.....	110
Installing the left control panel.....	111
<b>Chapter 8: Upgrade Kits.....</b>	<b>113</b>
BOSS-N1 module kit.....	113
GPU kit.....	116
Filter bezel kit.....	116
<b>Chapter 9: Jumpers and connectors.....</b>	<b>119</b>
System board jumpers and connectors .....	119
System board jumper settings.....	120
Disabling a forgotten password.....	121
<b>Chapter 10: System diagnostics and indicator codes.....</b>	<b>122</b>
Status LED indicators.....	122
System health and system ID indicator codes.....	123
iDRAC Direct LED indicator codes.....	124
NIC indicator codes.....	124
Power supply unit indicator codes.....	125
Drive indicator codes.....	126
Power button LED.....	127
<b>Chapter 11: Using system diagnostics.....</b>	<b>128</b>
Dell Embedded System Diagnostics.....	128
Running the Embedded System Diagnostics from Boot Manager.....	128
Running the Embedded System Diagnostics from the Dell Lifecycle Controller.....	128
System diagnostic controls.....	129
<b>Chapter 12: Getting help.....</b>	<b>130</b>
Recycling or End-of-Life service information.....	130
Contacting Dell Technologies.....	130
Accessing system information by using QRL.....	130
Quick Resource Locator for PowerEdge R360 system.....	131
Receiving automated support with Secure Connect Gateway (SCG).....	131
<b>Chapter 13: Documentation resources.....</b>	<b>132</b>

# About this document

This document provides an overview about the system, information about installing and replacing components, diagnostic tools, and guidelines to be followed while installing certain components.

# PowerEdge R360 system overview

The PowerEdge R360 system is a 1U server that supports:

- One Intel Xeon E-2400 series processor with up to with up to eight cores or One Intel Pentium processor with two cores
- Four DIMM slots
- Two redundant AC or DC power supply units
- Up to 8 x 2.5 inch SAS/SATA (HDD/SSD) drives or Up to 4 x 3.5 inch SAS/SATA (HDD/SSD) drives or Up to 4 x 2.5 inch SAS/SATA (HDD/SSD) drives with 3.5 inch to 2.5-inch adapter in 3.5-inch carrier.

**NOTE:** All instances of SAS, SATA drives are referred to as drives in this document, unless specified otherwise.

**CAUTION:** Do not install GPUs, network cards, or other PCIe devices on your system that are not validated and tested by Dell. Damage caused by unauthorized and invalidated hardware installation will null and void the system warranty.

## Topics:

- [Front view of the system](#)
- [Rear view of the system](#)
- [Inside the system](#)
- [Locating the Express Service Code and Service Tag](#)
- [System information labels](#)
- [Rail sizing and rack compatibility matrix](#)

## Front view of the system



Figure 1. Front view of 4 x 3.5-inch drive system

Table 1. Features are available on the front of the system for a 3.5-inch drive system

Item	Ports, panels, and slots	Icon	Description
1	Left control panel	N/A	Contains the system health, system ID, and the status LED indicator.
2	3.5-inch drive or 2.5-inch drive in 3.5-inch carrier adapter.	NA	Enables you to install drives that are supported on your system. <b>NOTE:</b> For drive slot numbers, see the <a href="#">system information label</a> section.

**Table 1. Features are available on the front of the system for a 3.5-inch drive system (continued)**

Item	Ports, panels, and slots	Icon	Description
3	Right control panel	N/A	Contains the Power button, USB 2.0 port and iDRAC direct Micro USB port

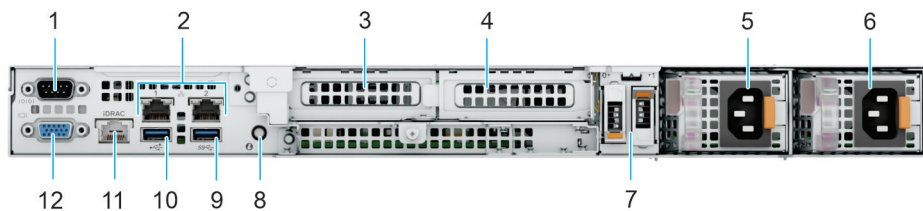

**Figure 2. Front view of 8 x 2.5-inch drive system**

**Table 2. Features are available on the front of the system for a 2.5-inch drive system**

Item	Ports, panels, and slots	Icon	Description
1	Left control panel	N/A	Contains the system health, system ID, and the status LED indicator.
2	2.5-inch drive	NA	Enables you to install drives that are supported on your system. <b>i</b> <b>NOTE:</b> For drive slot numbers, see the <a href="#">system information label</a> section.
3	Right control panel	N/A	Contains the Power button, USB 2.0 port and iDRAC direct Micro USB port

## Rear view of the system









**Figure 3. Rear view of the system**

**Table 3. Features available on the rear of the system**



Item	Ports, panels, or slots	Icon	Description
1	Serial port	IOIOI	Enables you to connect a serial device to the system.

**Table 3. Features available on the rear of the system (continued)**

Item	Ports, panels, or slots	Icon	Description
2	NIC ports		The NIC ports that are integrated on the system board provide network connectivity.
3	PCIe expansion riser card slot 1	N/A	The expansion card riser enables you to connect PCI Express expansion cards. For more information, see the Expansion card installation guidelines section.
4	PCIe expansion riser card slot 2	N/A	The expansion card riser enables you to connect PCI Express expansion cards. For more information, see the Expansion card installation guidelines section.
5	Power supply unit (PSU 1)		Indicates the PSU.
6	Power supply unit (PSU 2)		Indicates the PSU.
7	BOSS-N1 module	N/A	BOSS-N1 module for internal system boot.
8	System Identification (ID) button		<p>The System Identification (ID) button is available on the front and back of the system. Press the button to identify a system in a rack by turning on the system ID button. You can also use the system ID button to reset iDRAC and to access BIOS using the step through mode. When pressed, the system ID LED in the back panel blinks until either the front or rear button is pressed again. Press the button to toggle between on or off mode.</p> <p> <b>NOTE:</b> If the server stops responding during POST, press and hold the <b>System ID</b> button for more than five seconds to enter the BIOS progress mode</p> <p> <b>NOTE:</b> To reset the iDRAC (if not disabled on the iDRAC setup page by pressing F2 during system boot), press and hold the <b>System ID</b> button for more than 15 seconds.</p>
9	USB 3.2 Gen1 port		This port is USB 3.2 Gen1-compliant.



**Table 3. Features available on the rear of the system (continued)**

Item	Ports, panels, or slots	Icon	Description
10	USB 2.0 port		This port is USB 2.0-compliant.
11	Dedicated iDRAC Ethernet port	<b>iDRAC</b>	Enables you to remotely access iDRAC. For more information, see the Integrated Dell Remote Access Controller User's Guide at <a href="#">PowerEdge Manuals</a> .
12	VGA port		Enables you to connect a display device to the system.

## Inside the system

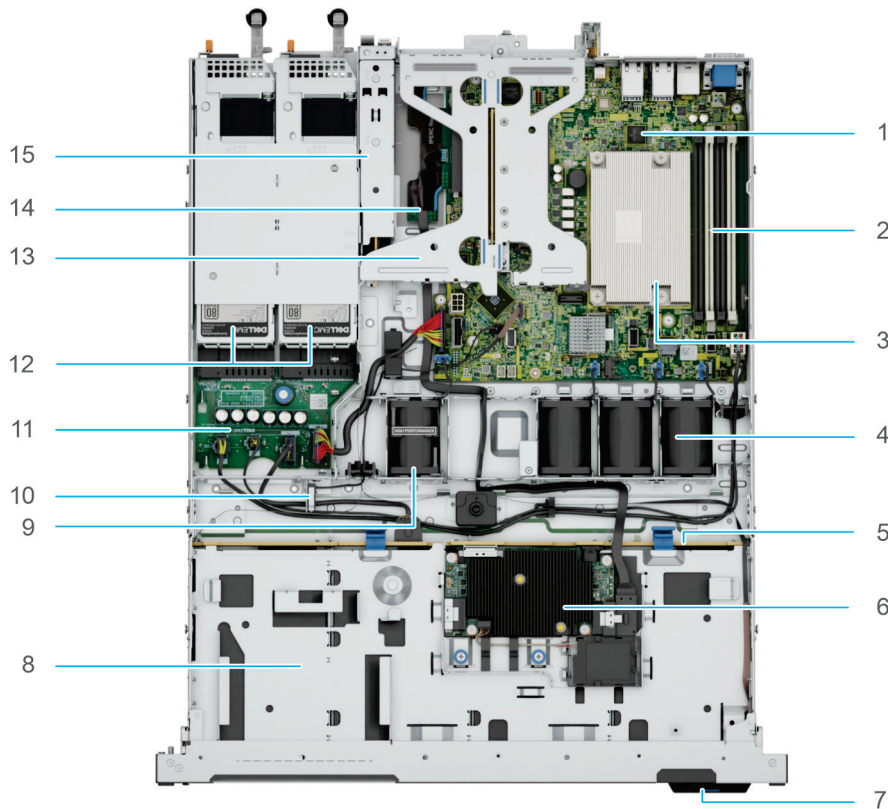

**Figure 4. Inside the system**

1. System board
2. DIMM slots
3. Processor heatsink
4. Standard (STD) cooling fans
5. Drive backplane
6. Front PERC card
7. Express Service Code Tag
8. Front drives
9. High Performance (HPR) fan - Optional
10. Intrusion switch
11. Power Interposer board (PIB)
12. Power supply units

- 13. Butterfly Riser with 2x PCIe slots
- 14. Front PERC card riser on the dedicated internal PCIe slot
- 15. BOSS N1 module

## Locating the Express Service Code and Service Tag

The unique Express Service Code and Service Tag are used to identify the system.

The information tag is located on the front of the system that includes system information such as the Service Tag, Express Service Code, Manufacture date, NIC, MAC address, QRL label, and so on. If you have opted for the secure default access to iDRAC, the Information tag also contains the iDRAC secure default password.

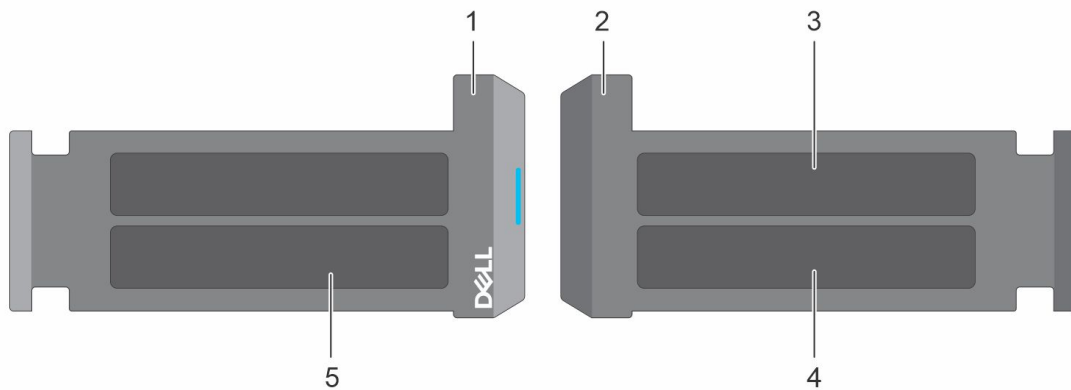

**Figure 5. Locating the Express Service Code and Service tag**

- 1. Information tag (front view)
- 2. Information tag (back view)
- 3. iDRAC MAC address and iDRAC secure password label
- 4. Service Tag, Express Service Code, QRL label

The Mini Enterprise Service Tag (MEST) label is on the rear of the system that includes the Service Tag (ST), and Express Service Code (Exp Svc Code). The Exp Svc Code is used by Dell to route support calls to the appropriate personnel.

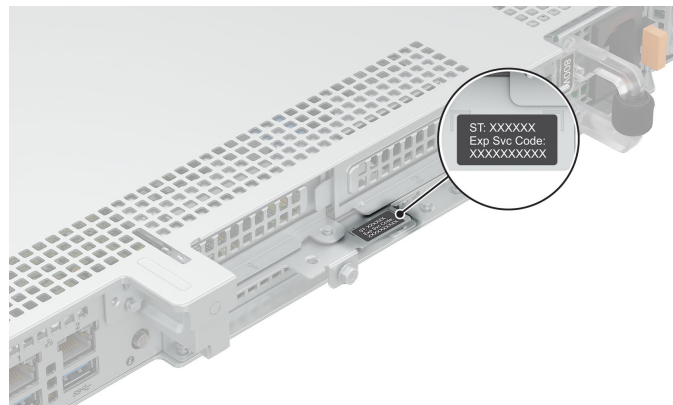

**Figure 6. Locating the Mini Express Service Tag**

## System information labels

The system information label is located on the back side of the system cover.

## System Touchpoints

- Hot swap touchpoints: Components with terracotta touchpoints can be serviced while the system is running.
- Cold swap touchpoints: Components with blue touchpoints require a full system shutdown before servicing.

Figure 7. System touchpoints

## 2 Jumper Settings

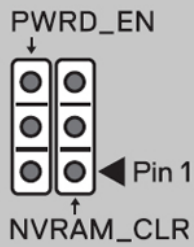

BIOS password is **enabled**. (default)

BIOS password is **disabled**.

BIOS configuration settings **retained** at system boot. (default)

BIOS configuration settings **cleared** at system boot.

Figure 8. Jumper settings

# Electrical Overview

## System Board Connections

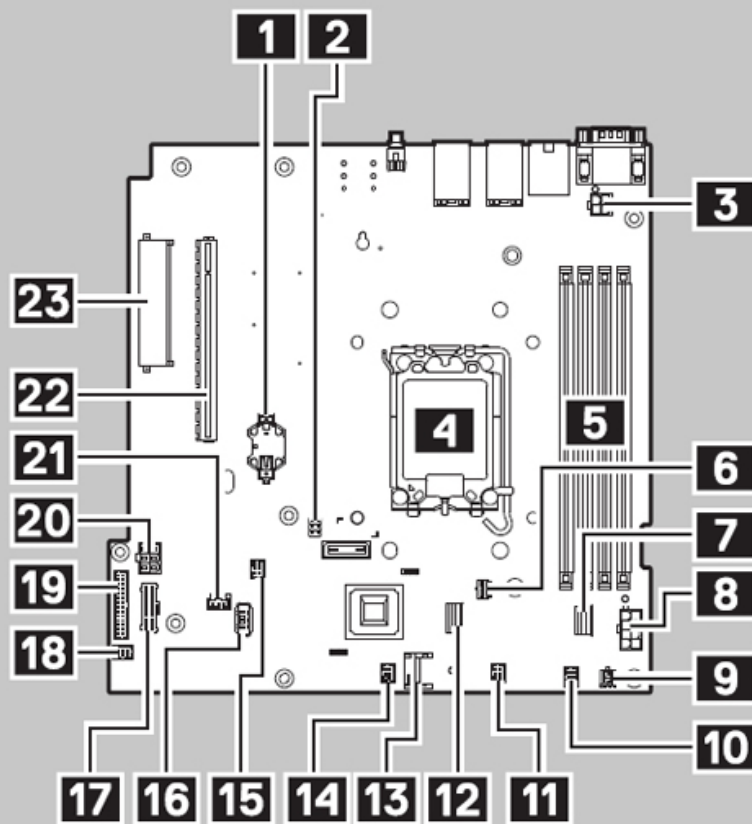

- 1** Coin Cell Battery
- 2** Jumper
- 3** CPU Power
- 4** CPU
- 5** DIMMs
- 6** BOSS Card Power
- 7** SATA Connector (SL1\_PCH\_SA1)
- 8** Power Connector
- 9** PSU Event Signal Cable
- 10** FAN 4
- 11** FAN 3
- 12** BOSS Connector (SL2\_PCH\_PA2)
- 13** TPM Connector
- 14** FAN 2
- 15** Left Control Panel
- 16** Internal USB 3.0
- 17** Right Control Panel
- 18** FAN 1
- 19** PIB Connector
- 20** HDD Power
- 21** Intrusion Switch Connector
- 22** Riser Connector
- 23** Internal PERC Connector

Figure 9. Electrical overview

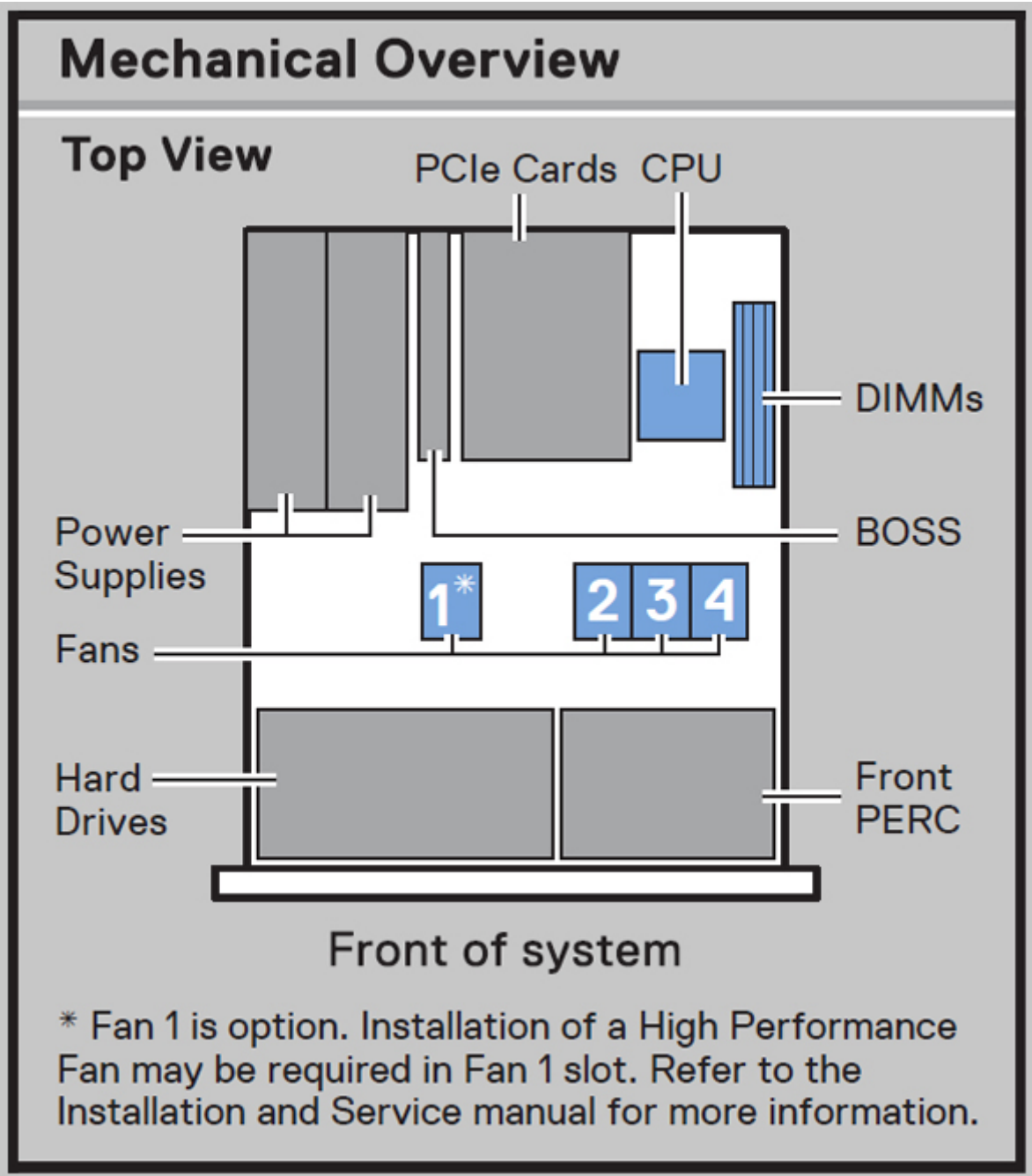

Figure 10. Mechanical overview



Figure 11. Quick Resource Locator

## Rail sizing and rack compatibility matrix

For specific information about the rail solutions compatible with your system, see the [Dell Enterprise Systems Rail Sizing and Rack Compatibility Matrix](#).

The document provides the information that is listed below:

- Specific details about rail types and their functionalities.
- Rail adjustability range for various types of rack mounting flanges.
- Rail depth with and without cable management accessories.
- Types of racks that are supported for various types of rack mounting flanges.

# Technical specifications

The technical and environmental specifications of your system are outlined in this section.

**Topics:**

- Chassis dimensions
- System weight
- Processor specifications
- PSU specifications
- Cooling fan specifications
- Supported operating systems
- System battery specifications
- Expansion card riser specifications
- Memory specifications
- Storage controller specifications
- Drives
- GPU specifications
- Ports and connectors specifications
- Video specifications
- Environmental specifications

# Chassis dimensions

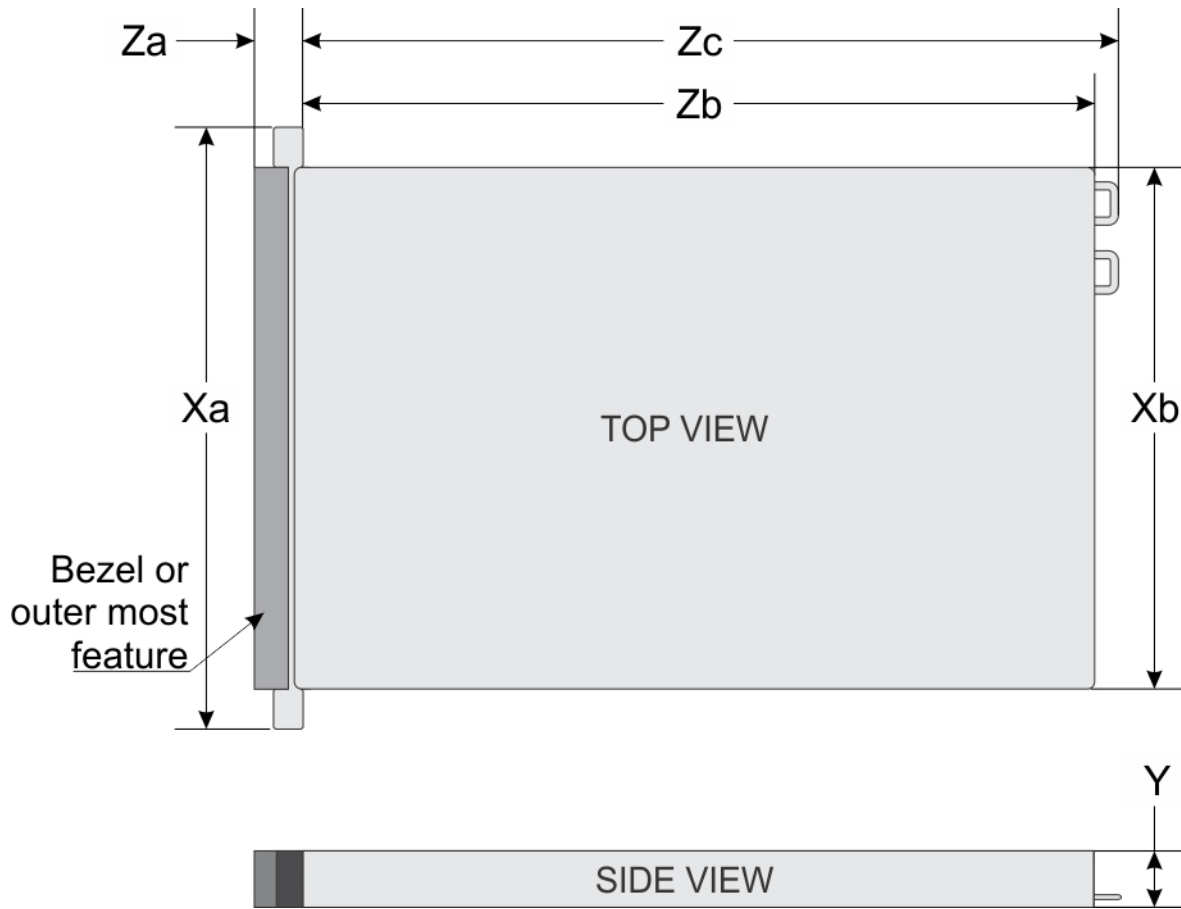

Figure 12. Chassis dimensions

Table 4. PowerEdge R360 chassis dimensions

Drives	Xa	Xb	Y	Za	Zb	Zc
8 drives 2.5 - inch	482.0 mm (18.976 inches)	434.0 mm (17.086 inches)	42.8 mm (1.685 inches)	With bezel 35.6 mm (1.401 inches) Without bezel 22.0 mm (0.866 inches)	483.82 mm (19.048 inches)	512.53 mm (20.178 inches)
4 drives 3.5 - inch	482.0 mm (18.976 inches)	434.0 mm (17.086 inches)	42.8 mm (1.685 inches)	With bezel 35.6 mm (1.401 inches) Without bezel 22.0 mm (0.866 inches)	534.59 mm (21.046 inches)	563.3 mm (22.177 inches)

**NOTE:** Zb is the nominal rear wall external surface where the system board I/O connectors reside.

# System weight

Table 5. PowerEdge R360 system weight

System configuration	Maximum weight (with all drives/SSDs)	
A server with fully populated drives	2.5 inch drives	11.64 kg (25.68 pounds)



**Table 5. PowerEdge R360 system weight (continued)**

System configuration	Maximum weight (with all drives/SSDs)	
	3.5 inch drives	13.23 kg (29.17 pounds)
A server without drives and PSU installed	2.5 inch drives	8.36 kg (18.45 pounds)
	3.5 inch drives	9.01 kg (19.88 pounds)

## Processor specifications

**Table 6. PowerEdge R360 processor specifications**

Supported processor	Number of processors supported
Intel® Pentium G7400/G7400T processor with up to 2 cores	One
Intel® Xeon E-2400 series processors with up to 8 cores	One

## PSU specifications

The PowerEdge R360 system supports up to two AC or DC power supply units (PSUs).

**Table 7. PSU specifications**

PSU	Class	Heat dissipation (maximum) (BTU/hr)	Frequency (Hz)	Voltage	AC		DC	Current (A)
					High line 200–240 V	Low line 100–120 V		
600 W	Platinum	2250	50/60	100 — 240 V AC	600 W	600 W	NA	7.1 - 3.6
	NA		NA	240 V DC	NA	NA	600 W	2.9
700 W	Titanium	2625	50/60	200 — 240 V AC	700 W	NA	NA	4.1
	NA		NA	240 V DC	NA	NA	700 W	3.4

**NOTE:** This system is also designed to connect to the IT power systems with a phase-to-phase voltage not exceeding 240 V.

**NOTE:** Heat dissipation is calculated using the PSU wattage rating.

**NOTE:** When selecting or upgrading the system configuration, to ensure optimum power utilization, verify the system power consumption with the Enterprise Infrastructure Planning Tool at [Dell.com/calculator](https://www.dell.com/calculator).

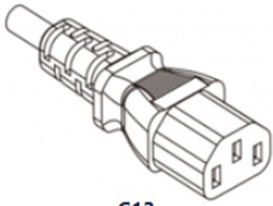

C13

Figure 13. PSU power cord

Table 8. PSU power cords

Form factor	Output	Power cord
Redundant 60 mm	600 W	C13 /C14 (inlet)
	700 W	

## Cooling fan specifications

The PowerEdge R360 system supports up to a maximum of four fans, three Brickfielder (BF), and one High performance (HPR) cooling fan based on the system configuration. These fans are not hot swappable.

Table 9. Cooling fan specifications

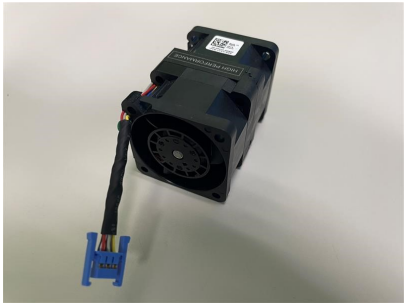
Fan type	Abbreviation	Label color	Label image
Standard (STD) fans	STD	No label	
High performance (HPR) silver fans	HPR	Silver	

# Supported operating systems

The PowerEdge R360 system supports the following operating systems:

- Canonical Ubuntu Server LTS
- Microsoft Windows Server with Hyper-V
- Red Hat Enterprise Linux
- SUSE Linux Enterprise Server
- VMware ESXi

For more information, go to [OS support](#).

# System battery specifications

The PowerEdge R360 system uses one CR 2032 3.0-V lithium coin cell battery.

# Expansion card riser specifications

The PowerEdge R360 system supports up to two Gen5 PCI express (PCIe) slots on the riser and one PCI express (PCIe) slot for PERC on system board.

**Table 10. Expansion card slots supported on the system board**

-	With Regular shroud	No Riser	Butterfly Riser	
			Mechanical	Electrical
Internal Slot	Half Length, Low Profile	X4	X8	X4
Slot-1 (Riser)	Half Length, Low Profile	-	X8	X8
Slot-2 (Riser)	Half Length, Low Profile	-	X16	X8

# Memory specifications

The PowerEdge R360 system supports DDR5 UDIMM ECC memory in the following memory specifications for optimized operation.

**Table 11. Memory specifications**

DIMM type	DIMM rank	DIMM capacity	Single processor	
			Minimum system capacity	Maximum system capacity
DDR5 ECC UDIMM	Single rank	16 GB	16 GB	64 GB
	Dual rank	32 GB	32 GB	128 GB

**Table 12. Memory module sockets**

Memory module sockets	Speed
4, 288-pin	Up to 4400 MT/s

 **NOTE:** Memory DIMM slots are not hot pluggable.

**NOTE:** The operating speed of the memory will be reduced due to processor limitation. For more information, refer R360 Technical Guide at [PowerEdge Manuals](#)

## Storage controller specifications

The PowerEdge R360 system supports the following controller cards with a maximum of one internal controller and one external controller:

**Table 13. Storage controller cards**

Supported storage controller cards
Internal controllers <ul style="list-style-type: none"><li>PERC H355</li><li>PERC H755</li><li>PERC H355 Front</li><li>PERC H755 Front</li></ul>
External controllers <ul style="list-style-type: none"><li>HBA355e</li></ul>
Software RAID <ul style="list-style-type: none"><li>S160</li></ul>
Internal Boot <ul style="list-style-type: none"><li>Boot Optimized Storage Subsystem (BOSS-N1): HWRAID 2 x M.2 NVMe SSDs</li></ul>
SAS Hot Bus Adapters (HBA) <ul style="list-style-type: none"><li>HBA355i, HBA355i Front</li></ul>

## Drives

The PowerEdge R360 system supports:

Front Drives

- 8 x 2.5-inch hot-swappable SAS,SATA drives through PERC
- 4 x 3.5-inch hot-swappable SAS,SATA drives through PERC
- 4 x 3.5-inch hot-swappable SATA drives through chipset

## GPU specifications

The PowerEdge R360 system supports one 60 W low profile Nvidia A2 GPU on the riser.

**NOTE:** Systems configured with GPUs will have higher fan acoustics.

**NOTE:** The R360 with GPU configuration is not recommended for an acoustic sensitive environment (Office environment, or general use space etc.).

## Ports and connectors specifications

### NIC port specifications

The PowerEdge R360 system supports up to two 10/100/1000 Mbps Network Interface Controller (NIC) ports embedded on the LAN on Motherboard (LOM).

**Table 14. NIC port specification for the system**

Feature	Specifications
LOM	1 Gb x 2
Network Card	1 GbE x 4, 10 GbE x 2, 10 GbE x 4

## Serial connector specifications

The PowerEdge R360 system supports one serial port on the system board, which is Data Terminal Equipment (DTE), 16550-compliant .

The serial connector is installed as default on the system board.

## USB ports specifications

**Table 15. PowerEdge R360 USB specifications**

Front		Rear		Internal	
USB port type	No. of ports	USB port type	No. of ports	USB port type	No. of ports
USB 2.0-compliant port	One	USB 2.0-compliant port	One	Internal USB 3.2 Gen1-compliant port	One
iDRAC Direct port (Micro-AB USB 2.0-compliant port)	One	USB 3.2 Gen1-compliant ports	One		

 **NOTE:** The micro USB 2.0 compliant port can only be used as an iDRAC Direct or a management port.

## VGA ports specifications

The PowerEdge R360 system supports DB-15 VGA port on rear of the system

## Video specifications

The PowerEdge R360 system supports integrated Matrox G200eW graphics controller with 16 MB of video frame buffer.

**Table 16. Supported video resolution options**

Resolution	Refresh rate (Hz)	Color depth (bits)
640 x 480	60 Hz	32
640 x 480	72 Hz	32
640 x 480	75 Hz	32
640 x 480	85 Hz	32
800 x 600	60 Hz	32
800 x 600	72 Hz	32
800 x 600	75 Hz	32
800 x 600	85 Hz	32
1024 x 768	60 Hz	32
1024 x 768	72 Hz	32

**Table 16. Supported video resolution options (continued)**

Resolution	Refresh rate (Hz)	Color depth (bits)
1024 x 768	75 Hz	32
1024 x 768	85 Hz	32
1280 x 800	60 Hz	32
1280 x 800	75 Hz	32
1280 x 1024	60 Hz	32
1280 x 1024	75 Hz	32
1360 x 768	60 Hz	32
1440 x 900	60 Hz	32
1440 x 900	60 Hz (RB)	32
1600 x 900	60 Hz (RB)	32
1600 x 900	60 Hz (RB)	32
1600 x 1200	60 Hz	32
1600 x 1200	60 Hz (RB)	32
1680 x 1050	60 Hz (RB)	32
1680 x 1050	60 Hz	32
1920 x 1080	60 Hz	32
1920 x 1080	60 Hz (RB)	32
1920 x 1200	60 Hz	32
1920 x 1200	60 Hz (RB)	32

## Environmental specifications

 **NOTE:** For additional information about environmental certifications, refer to the *Product Environmental Datasheet* located with the *Documentation* on [Dell Support](#).

**Table 17. Continuous Operation Specifications for ASHRAE A2**

-	Allowable continuous operations
Temperature range for altitudes <= 900 m (<= 2953 ft)	10–35°C (50–95°F) with no direct sunlight on the equipment
Humidity percent range (non-condensing at all times)	8% RH with -12°C minimum dew point to 80% RH with 21°C (69.8°F) maximum dew point
Operational altitude de-rating	Maximum temperature is reduced by 1°C/300 m (33.8°F/984 Ft) above 900 m (2953 Ft)

**Table 18. Continuous Operation Specifications for ASHRAE A3**

-	Allowable continuous operations
Temperature range for altitudes <= 900 m (<= 2953 ft)	5–40°C (41–104°F) with no direct sunlight on the equipment
Humidity percent range (non-condensing at all times)	8% RH with -12°C minimum dew point to 85% RH with 24°C (75.2°F) maximum dew point
Operational altitude de-rating	Maximum temperature is reduced by 1°C/175 m (33.8°F/574 Ft) above 900 m (2953 Ft)

**Table 19. Continuous Operation Specifications for ASHRAE A4**

-	Allowable continuous operations
Temperature range for altitudes <= 900 m (<= 2953 ft)	5–45°C (41–113°F) with no direct sunlight on the equipment
Humidity percent range (non-condensing at all times)	8% RH with -12°C minimum dew point to 90% RH with 24°C (75.2°F) maximum dew point
Operational altitude de-rating	Maximum temperature is reduced by 1°C/125 m (33.8°F/410 Ft) above 900 m (2953 Ft)

**Table 20. Common Environmental Specifications for ASHRAE A2, A3, and A4**

-	Allowable continuous operations
Maximum temperature gradient (applies to both operation and non-operation)	20°C in an hour* (36°F in an hour) and 5°C in 15 minutes (41°F in 15 minutes), 5°C in an hour* (41°F in an hour) for tape <i>i</i> <b>NOTE:</b> * - Per ASHRAE thermal guidelines for tape hardware, these are not instantaneous rates of temperature change.
Non-operational temperature limits	-40 to 65°C (-104 to 149°F)
Non-operational humidity limits	5% to 95% RH with 27°C (80.6°F) maximum dew point
Maximum non-operational altitude	12,000 meters (39,370 feet)
Maximum operational altitude	3,048 meters (10,000 feet)

**Table 21. Maximum vibration specifications**

Maximum vibration	Specifications
Operating	0.21 G <sub>rms</sub> at 5 Hz to 500 Hz (all operation orientations)
Storage	1.88 G <sub>rms</sub> at 10 Hz to 500 Hz for 15 minutes (all six sides tested)

**Table 22. Maximum shock pulse specifications**

Maximum shock pulse	Specifications
Operating	Six consecutively executed shock pulses in the positive and negative x, y, and z axis of 6 G for up to 11 ms.
Storage	Six consecutively executed shock pulses in the positive and negative x, y, and z axis (one pulse on each side of the system) of 71 G for up to 2 ms.

## Thermal air restrictions

### ASHRAE A3/A4 environment

- The operating temperature is for a maximum altitude of 950 m for ASHRAE A3/A4 Cooling.
- If over 950 m, we need to do the ambient temperature de-rating.
- CPU TDP greater than 80 W is not supported.
- BOSS-N1 (M.2) module is not supported.
- A2 GPU card is not supported.
- Non-Dell qualified peripheral cards and/or peripheral cards greater than 25 W are not supported.
- Two PSUs are required in redundant mode.

# Thermal restriction matrix

**Table 23. Processor and heat sink matrix**

Heat sink	Configuration No
1U HSK	All configurations

**Table 24. Label reference**

Label	Description
STD	Standard
LP	Low profile
FH	Full height

**Table 25. Thermal restriction matrix**

Configuration		Configuration 1 2.5 inch and 3.5 inch Drives With Riser	Configuration 2 2.5 inch and 3.5 inch Drives With N1- BOSS	Configuration 3 2.5 inch and 3.5 inch Drives Without Riser and N1 - BOSS	Ambient temperature
CPU TDP/ cTDP	≤ 80 W	4 x STD Fans 1U STD HSK	1 x Silver Fan, 3 x STD Fans 1U STD HSK	3 x STD Fan 1U STD HSK	35°C (95°F)
	95 W	4 x STD Fans 1U Performance HSK	1 x Silver Fan, 3 x STD 1U Performance HSK	3 x STD Fan 1U Performance HSK	35°C (95°F)

**Table 26. GPU thermal restriction matrix**

Configuration		Configuration 1 2.5 inch and 3.5 inch Drives With Riser	Configuration 2 2.5 inch and 3.5 inch Drives With N1- BOSS	Configuration 3 2.5 inch and 3.5 inch Drives Without Riser and N1 - BOSS	Ambient temperature
CPU TDP/ cTDP	≤ 80 W	4 x STD Fans 1U STD HSK	1 x Silver Fan, 3 x STD Fans 1U STD HSK	NA	35°C (95°F)
	95 W	4 x STD Fans 1U Performance HSK	1 x Silver Fan, 3x STD 1U Performance HSK	NA	35°C (95°F)

**NOTE:** When A2 GPU card is populated, PCIe slot 2 has to be populated or should have a blank installed.

**Table 27. Fan Location**

Chassis	Configuration	Fan Quantity	Fan Location
2.5 inch and 3.5 inch Drives	With Riser Card	4	Fan 1 (STD), Fan 2, Fan 3, Fan 4



**Table 27. Fan Location (continued)**

<b>Chassis</b>	<b>Configuration</b>	<b>Fan Quantity</b>	<b>Fan Location</b>
2.5 inch and 3.5 inch Drives	With N1-BOSS Module	4	Fan 1 (Silver), Fan 2, Fan 3, Fan 4
2.5 inch and 3.5 inch Drives	Without Riser and N1- BOSS Module	3	Fan 2, Fan 3, Fan 4

# Initial system setup and configuration

This section describes the tasks for initial setup and configuration of the Dell system. The section also provides general steps to set up the system and the reference guides for detailed information.

## Topics:

- [Setting up the system](#)
- [iDRAC configuration](#)
- [Resources to install operating system](#)

## Setting up the system

Perform the following steps to set up the system:

### Steps

Unpack the system.

## iDRAC configuration

The Integrated Dell Remote Access Controller (iDRAC) is designed to make you more productive as a system administrator and improve the overall availability of Dell servers. iDRAC alerts you to system issues, helps you to perform remote management, and reduces the need for physical access to the system.

## Options to set up iDRAC IP address

To enable communication between your system and iDRAC, you must first configure the network settings based on your network infrastructure. The network settings option is set to **DHCP**, by default.

**i** **NOTE:** For static IP configuration, you must request for the settings at the time of purchase.

You can set up the iDRAC IP address using one of the interfaces in the table below. For information about setting up iDRAC IP address, see the documentation links provided in the table below.

**i** **NOTE:** To access iDRAC, ensure that you connect the ethernet cable to the iDRAC dedicated network port or use the iDRAC Direct port by using the micro USB (type AB) cable.

## Options to log in to iDRAC

To log in to the iDRAC Web User Interface, open a browser and enter the IP address.

You can log in to iDRAC as:

- iDRAC user
- Microsoft Active Directory user
- Lightweight Directory Access Protocol (LDAP) user

In the login screen displayed, if you have opted for secure default access to iDRAC, the default username is `root` and enter the iDRAC secure default password available on back of the Information Tag. If you opted for legacy password, use the iDRAC legacy username and password - `root` and `calvin`, the iDRAC default password will be blank on the information tag. Then you will be prompted and required to create a password of your choice before proceeding. You can also log in by using your Single Sign-On or Smart Card.

**NOTE:** Ensure that you change the default username and password after setting up the iDRAC IP address.

For more information about logging in to the iDRAC and iDRAC licenses, see the latest [Integrated Dell Remote Access Controller User's Guide](#)

**NOTE:** To determine the most recent iDRAC release for your platform and for latest documentation version, see KB article [KB78115](#).

You can also access iDRAC using command-line protocol - RACADM. For more information, see the [Integrated Dell Remote Access Controller RACADM CLI Guide](#) .

You can also access iDRAC using automation tool - Redfish API. For more information, see the [Integrated Dell Remote Access Controller User's Guide Redfish API Guide](#).

## Resources to install operating system

If the system is shipped without an operating system, you can install a supported operating system by using one of the resources provided in the table below. For information about how to install the operating system, see the documentation links provided in the table below.

**Table 28. Resources to install the operating system**

Resource	Documentation links
iDRAC	<a href="#">Integrated Dell Remote Access Controller User's Guide</a> or for system specific Integrated Dell Remote Access Controller User's Guide, go to <a href="#">PowerEdge Manuals</a> > <b>Product Support</b> page of your system > <b>Documentation</b> . <b>NOTE:</b> To determine the most recent iDRAC release for your platform and for latest documentation version, see KB article at <a href="#">KB78115</a> .
Lifecycle Controller	Dell Lifecycle Controller User's Guide at <a href="#">iDRAC Manuals</a> or for system specific Dell Lifecycle Controller User's Guide , go to <a href="#">PowerEdge Manuals</a> > <b>Product Support</b> page of your system > <b>Documentation</b> . Dell recommends using Lifecycle Controller to install the OS, since all required drivers are installed on the system. <b>NOTE:</b> To determine the most recent iDRAC release for your platform and for latest documentation version, see KB article at <a href="#">KB78115</a> .
OpenManage Deployment Toolkit	<a href="#">OpenManage Manuals</a> > OpenManage Deployment Toolkit
Dell certified VMware ESXi	<a href="#">Virtualization solutions</a>

**NOTE:** For more information about installation and how-to videos for operating systems supported on PowerEdge systems, see [Supported Operating Systems for Dell PowerEdge systems](#).

## Options to download drivers and firmware

You can download the firmware from the Dell support site. For information about downloading firmware, see the [Downloading drivers and firmware](#) section.

You can also choose any one of the following options to download the firmware. For information about how to download the firmware, see the documentation links provided in the table below.

**Table 29. Options to download firmware**

Option	Documentation link
Using Integrated Dell Remote Access Controller Lifecycle Controller (iDRAC with LC)	<a href="#">iDRAC Manuals</a>
Using Dell Repository Manager (DRM)	<a href="#">OpenManage Manuals</a>
Using Dell Server Update Utility (SUU)	<a href="#">OpenManage Manuals</a>

**Table 29. Options to download firmware (continued)**

Option	Documentation link
Using Dell OpenManage Deployment Toolkit (DTK)	<a href="#">OpenManage Manuals</a>
Using iDRAC virtual media	<a href="#">iDRAC Manuals</a>

## Options to download and install OS drivers

You can choose any one of the following options to download and install OS drivers. For information about how to download or install OS drivers, see the documentation links provided in the table below.

**Table 30. Options to download and install OS drivers**

Option	Documentation
Dell support site	<a href="#">Downloading drivers and firmware</a> section.
iDRAC virtual media	<a href="#">Integrated Dell Remote Access Controller User's Guide</a> or for system specific, go to <a href="#">Integrated Dell Remote Access Controller User's Guide &gt; Product Support</a> page of your system > <b>Documentation</b> . <b>NOTE:</b> To determine the most recent iDRAC release for your platform and for latest documentation version, see <a href="#">Integrated Dell Remote Access Controller Release Notes</a> .

## Downloading drivers and firmware

It is recommended that you download and install the latest BIOS, drivers, and systems management firmware on the system.

### Prerequisites

Ensure that you clear the web browser cache before downloading the drivers and firmware.

### Steps

1. Go to [Drivers](#).
2. Enter the Service Tag of the system in the **Enter a Dell Service Tag, Dell Product ID or Model** field, and then press Enter.  
**NOTE:** If you do not have the Service Tag, click **Browse all products**, and navigate to your product.
3. On the displayed product page, click **Drivers & Downloads**.  
On the **Drivers & Downloads** page, all drivers that are applicable to the system are displayed.
4. Download the drivers to a USB drive, CD, or DVD.

# Pre-operating system management applications

You can manage basic settings and features of a system without booting to the operating system by using the system firmware.

## Options to manage the pre-operating system applications

You can use any one of the following options to manage the pre-operating system applications:

- System Setup
- Dell Lifecycle Controller
- Boot Manager
- Preboot Execution Environment (PXE)

### Topics:

- [System Setup](#)
- [Dell Lifecycle Controller](#)
- [Boot Manager](#)
- [PXE boot](#)

## System Setup

Using the

**System Setup** option, you can configure the BIOS settings, iDRAC settings, and device settings of the system.

You can access system setup by using any one of the following interfaces:

- Graphical User interface — To access go to iDRAC Dashboard, click **Configurations > BIOS Settings**.
- Text browser — To enable the text browser, use the Console Redirection.

To view

**System Setup**, power on the system, press F2, and click **System Setup Main Menu**.

 **NOTE:** If the operating system begins to load before you press F2, wait for the system to finish booting, and then restart the system and try again.

The options on the

**System Setup Main Menu** screen are described in the following table:

**Table 31. System Setup Main Menu**

Option	Description
<b>System BIOS</b>	Enables you to configure the BIOS settings.
<b>iDRAC Settings</b>	Enables you to configure the iDRAC settings. The iDRAC settings utility is an interface to set up and configure the iDRAC parameters by using UEFI (Unified Extensible Firmware Interface). You can enable or disable various iDRAC parameters by using the iDRAC settings utility. For more information about this utility, see <a href="#">Integrated Dell Remote Access Controller User's Guide</a>

**Table 31. System Setup Main Menu (continued)**

Option	Description
<b>Device Settings</b>	Enables you to configure device settings for devices such as storage controllers or network cards.
<b>Service Tag Settings</b>	Enables you to configure the System Service Tag.

## System Information

To view the **System Information** screen, power on the system, press F2, and click **System Setup Main Menu > System BIOS > System Information**.

**Table 32. System Information details**

Option	Description
<b>System Model Name</b>	Specifies the system model name.
<b>System BIOS Version</b>	Specifies the BIOS version installed on the system.
<b>System Management Engine Version</b>	Specifies the current version of the Management Engine firmware.
<b>System Service Tag</b>	Specifies the system Service Tag.
<b>System Manufacturer</b>	Specifies the name of the system manufacturer.
<b>System Manufacturer Contact Information</b>	Specifies the contact information of the system manufacturer.
<b>System CPLD Version</b>	Specifies the current version of the system Complex Programmable Logic Device (CPLD) firmware.
<b>UEFI Compliance Version</b>	Specifies the UEFI compliance level of the system firmware.

## Memory Settings

To view the **Memory Settings** screen, power on the system, press F2, and click **System Setup Main Menu > System BIOS > Memory Settings**.

**Table 33. Memory Settings details**

Option	Description
<b>System Memory Size</b>	Specifies the size of the system memory.
<b>System Memory Type</b>	Specifies the type of memory installed in the system.
<b>System Memory Speed</b>	Specifies the speed of the system memory.
<b>Video Memory</b>	Specifies the size video memory.
<b>System Memory Testing</b>	Specifies whether the system memory tests are run during system boot. The two options available are <b>Enabled</b> and <b>Disabled</b> . This option is set to <b>Disabled</b> by default.
<b>Memory Operating Mode</b>	This field selects the memory operating mode. This feature is active only if a valid memory configuration is detected. When <b>Optimizer Mode</b> is enabled, the DRAM controllers operate independently in 64-bit mode and provide optimized memory performance. When <b>Dell Fault Resilient Mode (FRM)</b> is enabled, a percentage of the total installed memory is configured to create a fault resilient zone starting from lowest system memory address for use by select hypervisors for host virtualization resilience. Specify the FRM percentage by using the Fault Resilient Mode Memory Size[%] feature. When <b>Dell NUMA Fault Resilient Mode (FRM)</b> is enabled, a percentage of the installed memory in every NUMA node is configured to create a fault resilient zone for use by select

**Table 33. Memory Settings details (continued)**

Option	Description
	hypervisors for host virtualization resilience. Specify the FRM percentage by using the Fault Resilient Mode Memory Size[%] feature.
<b>Current State of Memory Operating Mode</b>	Specifies the current state of the memory operating mode.
<b>Memory training</b>	<p>When option is set to <b>Fast</b> and memory configuration is not changed, the system uses previously saved memory training parameters to train the memory subsystems and system boot time is also reduced. If memory configuration is changed, the system automatically enables <b>Retrain at Next boot</b> to force one-time full memory training steps, and then go back to <b>Fast</b> afterward.</p> <p>When option is set to <b>Retrain at Next boot</b>, the system performs the force one-time full memory training steps at next power on and boot time is slowed on next boot.</p> <p>When option is set to <b>Enable</b>, the system performs the force full memory training steps on every power on and boot time is slowed on every boot.</p>
<b>DIMM Population</b>	Provides information about the DIMM slots which has an installed DIMM.

## Processor Settings

To view the **Processor Settings** screen, power on the system, press F2, and click **System Setup Main Menu > System BIOS > Processor Settings**.

## SATA Settings

To view the **SATA Settings** screen, power on the system, press F2, and click **System Setup Main Menu > System BIOS > SATA Settings**.

**Table 34. SATA Settings details**

Option	Description
<b>Embedded SATA</b>	<p>Enables the embedded SATA option to be set to <b>Off</b>, <b>AHCI mode</b>, or <b>RAID modes</b>. This option is set to <b>AHCI Mode</b> by default.</p> <p><b>NOTE:</b></p> <ol style="list-style-type: none"> <li>1. You might also need to change the Boot Mode setting to UEFI. Otherwise, you should set the field to Non-RAID mode.</li> <li>2. No ESXi and Ubuntu OS support under RAID mode.</li> </ol>
<b>Security Freeze Lock</b>	Sends <b>Security Freeze Lock</b> command to the embedded SATA drives during POST. This option is applicable only for AHCI Mode. This option is set to <b>Enabled</b> by default.
<b>Write Cache</b>	Enables or disables the command for the embedded SATA drives during POST. This option is applicable only for AHCI Mode. This option is set to <b>Disabled</b> by default.
<b>Port n</b>	<p>Sets the drive type of the selected device.</p> <p>For <b>AHCI Mode</b>, BIOS support is always enabled.</p>

**Table 35. Port n**

Options	Descriptions
<b>Model</b>	Specifies the drive model of the selected device.
<b>Drive Type</b>	Specifies the type of drive attached to the SATA port.

**Table 35. Port n (continued)**

Options	Descriptions
Capacity	Specifies the total capacity of the drive. This field is undefined for removable media devices such as optical drives.

## Boot Settings

You can use the **Boot Settings** screen to set the boot mode to either **BIOS** or **UEFI**. It also enables you to specify the boot order. The **Boot Settings** only support **UEFI** mode.



- **UEFI:** The Unified Extensible Firmware Interface (UEFI) is a new interface between operating systems and platform firmware. The interface consists of data tables with platform related information, boot and runtime service calls that are available to the operating system and its loader. The following benefits are available when the **Boot Mode** is set to **UEFI**:
  - Support for drive partitions larger than 2 TB.
  - Enhanced security (e.g., UEFI Secure Boot).
  - Faster boot time.

 **NOTE:** You must use only the UEFI boot mode in order to boot from NVMe drives.

- **BIOS:** The **BIOS Boot Mode** is the legacy boot mode. It is maintained for backward compatibility.

To view the **Boot Settings** screen, power on the system, press F2, and click **System Setup Main Menu > System BIOS > Boot Settings**.

**Table 36. Boot Settings details**

Option	Description
<b>Boot Mode</b>	Enables you to set the boot mode of the system. If the operating system supports UEFI, you can set this option to UEFI. Setting this field to BIOS allows compatibility with non-UEFI operating systems. This option is set to <b>UEFI</b> by default.  <b>CAUTION: Switching the boot mode may prevent the system from booting if the operating system is not installed in the same boot mode.</b>  <b>NOTE:</b> Setting this field to UEFI disables the <b>BIOS Boot Settings</b> menu.
<b>Boot Sequence Retry</b>	Enables or disables the Boot sequence retry feature or resets the system. When this option is set to <b>Enabled</b> and the system fails to boot, the system re-attempts the boot sequence after 30 seconds. When this option is set to <b>Reset</b> and the system fails to boot, the system reboots immediately. This option is set to <b>Enabled</b> by default.
<b>Hard-disk Failover</b>	Enables or disables the Hard-disk failover. This option is set to <b>Disabled</b> by default.
<b>Generic USB Boot</b>	Enables or disables the generic USB boot placeholder. This option is set to <b>Disabled</b> by default.
<b>Hard-disk Drive Placeholder</b>	Enables or disables the Hard-disk drive placeholder. This option is set to <b>Disabled</b> by default.
<b>Clean all Sysprep variables and order</b>	When this option is set to <b>None</b> , BIOS will do nothing. When set to <b>Yes</b> , BIOS will delete variables of SysPrep #### and SysPrepOrder this option is a onetime option, will reset to none when deleting variables. This setting is only available in <b>UEFI Boot Mode</b> . This option is set to <b>None</b> by default.
<b>UEFI Boot Settings</b>	Specifies the UEFI boot sequence. Enables or disables UEFI Boot options.  <b>NOTE:</b> This option controls the UEFI boot order. The first option in the list will be attempted first.

**Table 37. UEFI Boot Settings**

Option	Description
<b>UEFI Boot Sequence</b>	Enables you to change the boot device order.
<b>Boot Option Enable/Disable</b>	Enables you to select the enabled or disabled boot devices



## Choosing system boot mode

System Setup enables you to specify one of the following boot modes for installing your operating system:

- UEFI boot mode (the default), is an enhanced 64-bit boot interface. If you have configured your system to boot to UEFI mode, it replaces the system BIOS.

1. From the **System Setup Main Menu**, click **Boot Settings**, and select **Boot Mode**.
2. Select the UEFI boot mode you want the system to boot into.

 **CAUTION: Switching the boot mode may prevent the system from booting if the operating system is not installed in the same boot mode.**

3. After the system boots in the specified boot mode, proceed to install your operating system from that mode.

 **NOTE:** Operating systems must be UEFI-compatible to be installed from the UEFI boot mode. DOS and 32-bit operating systems do not support UEFI and can only be installed from the BIOS boot mode.

 **NOTE:** For the latest information about supported operating systems, go to [OS support](#).

## Network Settings

To view the **Network Settings** screen, power on the system, press F2, and click **System Setup Main Menu > System BIOS > Network Settings**.

 **NOTE:** Network Settings are not supported in BIOS boot mode.

**Table 38. Network Settings details**

Option	Description
<b>UEFI PXE Settings</b>	Enables you to control the configuration of the UEFI PXE device.
<b>PXE Device n</b> (n = 1 to 4)	Enables or disables the device. When enabled, a UEFI PXE boot option is created for the device.
<b>PXE Device n Settings</b> (n = 1 to 4)	Enables you to control the configuration of the PXE device.
<b>UEFI HTTP Settings</b>	Enables you to control the configuration of the UEFI HTTP device.
<b>HTTP Device n</b> (n = 1 to 4)	Enables or disables the device. When enabled, a UEFI HTTP boot option is created for the device.
<b>HTTP Device n Settings</b> (n = 1 to 4)	Enables you to control the configuration of the HTTP device.
<b>UEFI iSCSI Settings</b>	Enables you to control the configuration of the iSCSI device.

**Table 39. PXE Device n Settings details**

Option	Description
<b>Interface</b>	Specifies NIC interface used for the PXE device.
<b>Protocol</b>	Specifies Protocol used for PXE device. This option is set to <b>IPv4</b> or <b>IPv6</b> . This option is set to <b>IPv4</b> by default.
<b>VLAN</b>	Enables Vlan for PXE device. This option is set to <b>Enabled</b> or <b>Disabled</b> . This option is set to <b>Disabled</b> by default.
<b>VLAN ID</b>	Shows the Vlan ID for the PXE device
<b>VLAN Priority</b>	Shows the Vlan Priority for the PXE device.

**Table 40. HTTP Device n Settings details**

Option	Description
<b>Interface</b>	Specifies the NIC interface used for the HTTP device.
<b>Protocol</b>	Specifies Protocol used for HTTP device. This option is set to <b>IPv4</b> or <b>IPv6</b> . This option is set to <b>IPv4</b> by default.

**Table 40. HTTP Device n Settings details (continued)**

Option	Description
<b>VLAN</b>	Enables Vlan for HTTP device. This option is set to <b>Enable</b> or <b>Disable</b> . This option is set to <b>Disable</b> by default.
<b>VLAN ID</b>	Shows the Vlan ID for the HTTP device
<b>Vlan Priority</b>	Shows the Vlan Priority for the HTTP device.
<b>DHCP</b>	Enables or disables DHCP for this HTTP device. This option is set to <b>Enabled</b> by default.
<b>IP Address</b>	Specifies IP address for the HTTP device.
<b>Subnet Mask</b>	Specifies subnet mask for the HTTP device.
<b>Autoconfiguration</b>	Enables or disables the <b>IPv6Autoconfiguration</b> for the HTTP Device. When set to Enabled, IPv6 Address and Gateway are retrieved from Autoconfiguration mechanism.
<b>Prefix Length</b>	IPv6 Prefix Length (0~127) for this HTTP Device.
<b>IPv6 Address</b>	IPv6 Unicast address for this HTTP Device.
<b>Gateway</b>	Specifies gateway for the HTTP device.
<b>DNS info via DHCP</b>	Enables or disables DNS Information from DHCP. This option is set to <b>Enabled</b> by default.
<b>Primary DNS</b>	Specifies the primary DNS server IP address for the HTTP Device.
<b>Secondary DNS</b>	Specifies the secondary DNS server IP address for the HTTP Device.
<b>URI (will obtain from DHCP server if not specified)</b>	Obtain URI from the DHCP server if not specified
<b>TLS Authentication Configuration</b>	Specifies the option for TLS authentication configuration.

 **NOTE:** Autoconfiguration, Prefix Length and IPv6 Address options are visible only when **Protocol** is set to **IPv6**

**Table 41. UEFI iSCSI Settings screen details**

Option	Description
<b>iSCSI Initiator Name</b>	Specifies the name of the iSCSI initiator in IQN format.
<b>iSCSI Device1</b>	Enables or disables the iSCSI device. When disabled, a UEFI boot option is created for the iSCSI device automatically. This is set to <b>Disabled</b> by default.
<b>iSCSI Device1 Settings</b>	Enables you to control the configuration of the iSCSI device.

**Table 42. iSCSI Device1 Settings screen details**

Option	Description
<b>Connection 1</b>	Enables or disables the iSCSI connection. This option is set to <b>Disabled</b> by default.
<b>Connection 2</b>	Enables or disables the iSCSI connection. This option is set to <b>Disabled</b> by default.
<b>Connection 1 Settings</b>	Enables you to control the configuration for the iSCSI connection.
<b>Connection 2 Settings</b>	Enables you to control the configuration for the iSCSI connection.
<b>Connection Order</b>	Enables you to control the order for which the iSCSI connections will be attempted.

## Integrated Devices

To view the **Integrated Devices** screen, power on the system, press F2, and click **System Setup Main Menu > System BIOS > Integrated Devices**.

**Table 43. Integrated Devices details**

Option	Description
<b>User Accessible USB Ports</b>	<p>Configures the user accessible USB ports. Selecting <b>Only Back Ports On</b> disables the front USB ports; selecting <b>All Ports Off</b> disables all front and back USB ports. This option is set to <b>All Ports On</b> by default.</p> <p>The USB keyboard and mouse still function in certain USB ports during the boot process, depending on the selection. After the boot process is complete, the USB ports will be enabled or disabled as per the setting.</p>
<b>Internal USB Port</b>	<p>Enables or disables the internal USB port. This option is set to <b>ON</b> by default.</p>
<b>iDRAC Direct USB Port</b>	<p>The iDRAC Direct USB port is managed by iDRAC exclusively with no host visibility. This option is set to <b>ON</b> or <b>OFF</b>. When set to <b>OFF</b>, iDRAC does not detect any USB devices installed in this managed port. This option is set to <b>On</b> by default.</p>
<b>Integrated RAID Controller</b>	<p>Enables or disables the Integrated RAID Controller. This option is set to <b>Enabled</b> by default. When set to <b>Disabled</b> the device is not visible to the operating system</p>
<b>Embedded NIC1 and NIC2</b>	<p>Enables or disables the OS interface of the Embedded NIC1 and NIC2 controller. If set to <b>Disabled (OS)</b>, the NIC may still be available for shared network access by the embedded management controller. Configure the <b>Embedded NIC1 and NIC2</b> option by using the NIC management utilities of the system. This option is set to <b>Enabled</b> by default.</p>
<b>I/OAT DMA Engine</b>	<p>Enables or disables the I/O Acceleration Technology (I/OAT) option. I/OAT is a set of DMA features designed to accelerate network traffic and lower CPU utilization. Enable only if the hardware and software support the feature. This option is set to <b>Disabled</b> by default.</p>
<b>Embedded Video Controller</b>	<p>Enables or disables the use of Embedded Video Controller as the primary display. When set to <b>Enabled</b>, the Embedded Video Controller will be the primary display even if add-in graphic cards are installed. When set to <b>Disabled</b>, an add-in graphics card is used as the primary display. BIOS will output displays to both the primary add-in video and the embedded video during POST and preboot environment. The embedded video will then be disabled right before the operating system boots. This option is set to <b>Enabled</b> by default.</p> <p><b>NOTE:</b> When there are multiple add-in graphic cards installed in the system, the first card discovered during PCI enumeration is selected as the primary video. You might have to rearrange the cards in the slots in order to control which card is the primary video.</p>
<b>Current State of Embedded Video Controller</b>	<p>Displays the current state of the embedded video controller. The <b>Current State of Embedded Video Controller</b> option is a read-only field. If the Embedded Video Controller is the only display capability in the system (that is, no add-in graphics card is installed), then the Embedded Video Controller is automatically used as the primary display even if the <b>Embedded Video Controller</b> setting is set to <b>Disabled</b>.</p>
<b>OS Watchdog Timer</b>	<p>If your system stops responding, this watchdog timer aids in the recovery of your operating system. When this option is set to <b>Enabled</b>, the operating system initializes the timer. When this option is set to <b>Disabled</b> (the default), the timer does not have any effect on the system.</p>
<b>Empty Slot Unhide</b>	<p>Enables or disables the root ports of all the empty slots that are accessible to the BIOS and operating system. This option is set to <b>Disabled</b> by default.</p>
<b>Slot Disablement</b>	<p>Enables or disables or boot driver disables the available PCIe slots on your system. The slot disablement feature controls the configuration of the PCIe cards installed in the specified slot. Slots must be disabled only when the installed peripheral card prevents booting into the operating system or causes delays in system startup. If the slot is disabled, both the Option ROM and UEFI drivers are disabled. Only slots that are present on the system will be available</p>

**Table 43. Integrated Devices details (continued)**





Option	Description
	for control. When this option is set to boot driver disabled, both the Option ROM and UEFI driver from the slot will not run during POST. The system will not boot from the card and its pre-boot services will not be available. However, the card is available to the operating system.
	<b>Slot n:</b> Enables or disables or only the boot driver is disabled for the PCIe slot n. This option is set to <b>Enabled</b> by default.

## Serial Communication

To view the **Serial Communication** screen, power on the system, press F2, and click **System Setup Main Menu > System BIOS > Serial Communication**.

 **NOTE:** PowerEdge R360 system does not support the serial COM port.

**Table 44. Serial Communication details**

Option	Description
<b>Serial Communication</b>	Enables the serial communication options. Selects serial communication devices (Serial Device 1 and Serial Device 2) in BIOS. BIOS console redirection can also be enabled, and the port address can be specified.
<b>Serial Port Address</b>	Enables you to set the port address for serial devices. This option is set to <b>Serial Device1=COM2,, Serial Device 2=COM1</b> and set to by default.  <b>NOTE:</b> You can use only Serial Device 2 for the Serial Over LAN (SOL) feature. To use console redirection by SOL, configure the same port address for console redirection and the serial device.  <b>NOTE:</b> Every time the system boots, the BIOS syncs the serial MUX setting that is saved in iDRAC. The serial MUX setting can independently be changed in iDRAC. Loading the BIOS default settings from within the BIOS setup utility may not always revert the serial MUX setting to the default setting of Serial Device 1.
<b>External Serial Connector</b>	Enables you to associate the External Serial Connector to <b>Serial Device 1</b> , <b>Serial Device 2</b> , or the <b>Remote Access Device</b> by using this option. This option is set to <b>Serial Device 1</b> by default.  <b>NOTE:</b> Only Serial Device 2 can be used for Serial Over LAN (SOL). To use console redirection by SOL, configure the same port address for console redirection and the serial device.  <b>NOTE:</b> Every time the system boots, the BIOS syncs the serial MUX setting saved in iDRAC. The serial MUX setting can independently be changed in iDRAC. Loading the BIOS default settings from within the BIOS setup utility may not always revert this setting to the default setting of Serial Device 1.
<b>Failsafe Baud Rate</b>	Specifies the failsafe baud rate for console redirection. The BIOS attempts to determine the baud rate automatically. This failsafe baud rate is used only if the attempt fails, and the value must not be changed. This option is set to <b>115200</b> by default.
<b>Remote Terminal Type</b>	Sets the remote console terminal type. This option is set to <b>VT100/VT220</b> by default.
<b>Redirection After Boot</b>	Enables or disables the BIOS console redirection when the operating system is loaded. This option is set to <b>Enabled</b> by default.

## System Profile Settings

To view the **System Profile Settings** screen, power on the system, press F2, and click **System Setup Main Menu > System BIOS > System Profile Settings**.

**Table 45. System Profile Settings details**

Option	Description
<b>System Profile</b>	<p>Sets the system profile. If you set the System Profile option to a mode other than <b>Performance Per Watt (DAPC)</b>, the BIOS automatically sets the rest of the options. You can only change the rest of the options if the mode is set to <b>Custom</b>. This option is set to <b>Performance Per Watt (DAPC)</b> by default. Other options include <b>Custom, Performance, Performance Per Watt (OS)</b> and <b>Workstation Performance</b>.</p> <p><b>NOTE:</b> All the parameters on the system profile setting screen are available only when the <b>System Profile</b> option is set to <b>Custom</b>.</p>
<b>CPU Power Management</b>	<p>Sets the CPU power management. This option is set to <b>System DBPM (DAPC)</b> by default. Other option includes <b>Maximum Performance, OS DBPM</b>.</p>
<b>Memory Frequency</b>	<p>Sets the speed of the system memory. You can select <b>Maximum Performance, Maximum Reliability</b> or a specific speed. This option is set to <b>Maximum Performance</b> by default.</p>
<b>Turbo Boost</b>	<p>Enables or disables the processor to operate in the turbo boost mode. This option is set to <b>Enabled</b> by default.</p>
<b>C1E</b>	<p>Enables or disables the processor to switch to a minimum performance state when it is idle. This option is set to <b>Enabled</b> by default.</p>
<b>C-States</b>	<p>Enables or disables the processor to operate in all available power states. C States allow the processor to enter lower power states when idle. When set to <b>Enabled</b> (OS controlled) or when set to <b>Autonomous</b> (if hardware controlled is supported), the processor can operate in all available Power States to save power, but may increase memory latency and frequency jitter. This option is set to <b>Enabled</b> by default.</p>
<b>Memory Refresh Rate</b>	<p>Sets the memory refresh rate to either 1x or 2x. This option is set to <b>2x</b> by default.</p>
<b>Uncore Frequency</b>	<p>Enables you to select the <b>Uncore Frequency</b> option. <b>Dynamic mode</b> enables the processor to optimize power resources across cores and uncores during runtime. The optimization of the uncore frequency to either save power or optimize performance is influenced by the setting of the <b>Energy Efficiency Policy</b> option.</p>
<b>Dynamic Load Line Switch</b>	<p>Dynamic Load Line Switch control. Dynamic Load Line (DLL) is a Power Management feature, which dynamically switches to the performance mode during periods of high CPU utilization. This setting is read-only and set to <b>Enabled</b> when Optimized Power Mode is Enabled. <b>Read - Only</b> unless System Profile is set to Custom.</p>
<b>Monitor/Mwait</b>	<p>Enables the Monitor/Mwait instructions in the processor. This option is set to <b>Enabled</b> for all system profiles, except <b>Custom</b> by default.</p> <p><b>NOTE:</b> This option can be disabled when System Profile is set to <b>Custom</b>.</p> <p><b>NOTE:</b> When C States is set to Enabled in the Custom mode, changing the Monitor/Mwait setting does not impact the system power or performance.</p>
<b>PCI ASPM L1 Link Power Management</b>	<p>Enables or disables the PCI <b>ASPM L1 Link Power Management</b>. This option is set to <b>Enabled</b> by default.</p>
<b>Workload Configuration</b>	<p>This feature allows you to select a preconfigured workload profile. This option is set to <b>IO Sensitive</b> by default.</p>

## System Security

To view the **System Security** screen, power on the system, press F2, and click **System Setup Main Menu > System BIOS > System Security**.

**Table 46. System Security details**

Option	Description
<b>CPU AES-NI</b>	Improves the speed of applications by performing encryption and decryption by using the Advanced Encryption Standard Instruction Set (AES-NI). This option is set to <b>Enabled</b> by default.
<b>System Password</b>	Sets the system password. This option is set to <b>Enabled</b> by default and is read-only if the password jumper is not installed in the system.
<b>Setup Password</b>	Sets the setup password. This option is read-only if the password jumper is not installed in the system.
<b>Password Status</b>	Locks the system password. This option is set to <b>Unlocked</b> by default.
<b>TPM Information</b>	Indicates the type of Trusted Platform Module, if present.

**Table 47. TPM 2.0 security information**

Option	Description
<b>TPM Information</b>	
<b>TPM Security</b>	 <b>NOTE:</b> The TPM menu is available only when the TPM module is installed. Enables you to control the reporting mode of the TPM. When set to Off, the presence of the TPM is not reported to the OS. When set to On, the presence of the TPM is reported to the OS. The <b>TPM Security</b> option is set to <b>Off</b> by default.
	When TPM 2.0 is installed, the <b>TPM Security</b> option is set to <b>On</b> or <b>Off</b> . This option is set to <b>Off</b> by default.
<b>TPM Information</b>	Indicates the type of Trusted Platform Module, if present.
<b>TPM Firmware</b>	Indicates the firmware version of the TPM.
<b>TPM Hierarchy</b>	Enables, disables, or clears the storage and endorsement hierarchies. When set to <b>Enabled</b> , the storage and endorsement hierarchies can be used.
	When set to <b>Disabled</b> , the storage and endorsement hierarchies cannot be used.
	When set to <b>Clear</b> , the storage and endorsement hierarchies are cleared of any values, and then reset to <b>Enabled</b> .
<b>TPM Advanced Settings</b>	<b>TPM PPI Bypass Provision</b> When set to <b>Enabled</b> , allows the Operating System to bypass Physical Presence Interface (PPI) prompts when issuing PPI Advanced Configuration and Power interface (ACPI) provisioning operations.
	<b>TPM PPI Bypass Clear</b> When set to <b>Enabled</b> allows the Operating System to bypass Physical Presence Interface (PPI) prompts when issuing PPI Advanced Configuration and Power Interface (ACPI) clear operations.
	<b>TPM2 Algorithm Selection</b> Allows the user to change the cryptographic algorithms used in the Trusted Platform Module (TPM). The available options are dependent on the TPM firmware.  To enable TPM2 Algorithm Selection, Intel(R) TXT technology must be disabled.  The TPM2 Algorithm Selection option supports SHA256 by detecting the TPM module. This option is set to <b>SHA256</b> by default.

**Table 48. System Security details**

Option	Description
<b>Power button:</b>	Enables or disables the power button on the front of the system. This option is set to <b>Enabled</b> by default.

**Table 48. System Security details (continued)**

Option	Description
<b>AC Power Recovery</b>	Sets how the system behaves after AC power is restored to the system. This option is set to <b>Last</b> by default. <b>i</b> <b>NOTE:</b> The host system will not power on up until iDRAC Root of Trust (RoT) is completed, host power on will be delayed by minimum 90 seconds after the AC applied.
<b>AC Power Recovery Delay</b>	Sets the time delay for the system to power up after AC power is restored to the system. This option is set to <b>Immediate</b> by default. When this option is set to <b>Immediate</b> , there is no delay for power up. When this option is set to <b>Random</b> , the system creates a random delay for power up. When this option is set to <b>User Defined</b> , the system delay time is manually to power up.
<b>User Defined Delay (120 s to 600 s)</b>	Sets the <b>User Defined Delay</b> option when the <b>User Defined</b> option for <b>AC Power Recovery Delay</b> is selected. The actual AC recovery time needs to add iDRAC root of trust time (around 50 seconds).
<b>UEFI Variable Access</b>	Provides varying degrees of securing UEFI variables. When set to <b>Standard</b> (the default), UEFI variables are accessible in the operating system per the UEFI specification. When set to <b>Controlled</b> , selected UEFI variables are protected in the environment and new UEFI boot entries are forced to be at the end of the current boot order.
<b>In-Band Manageability Interface</b>	When set to <b>Disabled</b> , this setting hides the Management Engine's (ME), HECI devices, and the system's IPMI devices from the operating system. This prevents the operating system from changing the ME power capping settings, and blocks access to all in-band management tools. All management should be managed through out-of-band. This option is set to <b>Enabled</b> by default. <b>i</b> <b>NOTE:</b> BIOS update requires HECI devices to be operational and DUP updates require IPMI interface to be operational. This setting needs to be set to Enabled to avoid updating errors.
<b>SMM Security Mitigation</b>	Enables or disables the UEFI SMM security migration protections. It is set to <b>Disabled</b> by default.
<b>Secure Boot</b>	Enables Secure Boot, where the BIOS authenticates each pre-boot image by using the certificates in the Secure Boot Policy. Secure Boot is set to <b>Disabled</b> by default.
<b>Secure Boot Policy</b>	When Secure Boot policy is set to <b>Standard</b> , the BIOS uses the system manufacturer's key and certificates to authenticate pre-boot images. When Secure Boot policy is set to <b>Custom</b> , the BIOS uses the user-defined key and certificates. Secure Boot policy is set to <b>Standard</b> by default.
<b>Secure Boot Mode</b>	Configures how the BIOS uses the Secure Boot Policy Objects (PK, KEK, db, dbx). If the current mode is set to <b>Deployed Mode</b> , the available options are <b>User Mode</b> and <b>Deployed Mode</b> . If the current mode is set to <b>User Mode</b> , the available options are <b>User Mode</b> , <b>Audit Mode</b> , and <b>Deployed Mode</b> . Below are the details of different boot modes available in the <b>Secure Boot Mode</b> option. <b>User Mode</b> In <b>User Mode</b> , PK must be installed, and BIOS performs signature verification on programmatic attempts to update policy objects. The BIOS allows unauthenticated programmatic transitions between modes. <b>Audit mode</b> In <b>Audit Mode</b> , PK is not present. BIOS does not authenticate programmatic update to the policy objects and transitions between modes. The BIOS performs a signature verification on pre-boot images and logs the results in the image Execution Information Table, but executes the images whether they pass or fail verification. <b>Audit Mode</b> is useful for programmatic determination of a working set of policy objects.



**Table 48. System Security details (continued)**

Option	Description
	<p><b>Deployed Mode</b> <b>Deployed Mode</b> is the most secure mode. In <b>Deployed Mode</b>, PK must be installed and the BIOS performs signature verification on programmatic attempts to update policy objects. <b>Deployed Mode</b> restricts the programmatic mode transitions.</p>
<p><b>Secure Boot Policy Summary</b></p>	<p>Specifies the list of certificates and hashes that secure boot uses to authenticate images. Below are the list of options available on the <b>Secure Boot Policy Summary</b> screen:</p> <ol style="list-style-type: none"> <li>1. <b>Platform Key (PK)</b></li> <li>2. <b>Key Exchange Key (KEK) Database Entries</b></li> <li>3. <b>Authorized Signature Database (db) Entries</b></li> </ol> <p>The options above are described through the following fields:</p> <ul style="list-style-type: none"> <li>• Type</li> <li>• Issuer</li> <li>• Subject</li> <li>• Signature Owner GUID</li> </ul> <ol style="list-style-type: none"> <li>4. <b>Forbidden Signature Database (dbx) Entries</b></li> </ol>
<p><b>Secure Boot Custom Policy Settings</b></p>	<p>Configures the Secure Boot Custom Policy. To enable this option, set the Secure Boot Policy to <b>Custom</b> option. Below are the list of options available on the <b>Secure Boot Custom Policy Settings</b> screen:</p> <ol style="list-style-type: none"> <li>1. <b>Platform Key (PK)</b></li> <li>2. <b>Key Exchange Key (KEK) Database</b></li> <li>3. <b>Authorized Signature Database (db)</b></li> <li>4. <b>Forbidden Signature Database (dbx)</b></li> <li>5. <b>Delete All Policy Entries (PK, KEK, db, and dbx)</b></li> <li>6. <b>Restore Default Policy Entries (PK, KEK, db, and dbx)</b></li> <li>7. <b>Export Firmware Hash Values</b></li> </ol>

## Creating a system and setup password

### Prerequisites

Ensure that the password jumper is enabled. The password jumper enables or disables the system password and setup password features. For more information, see the System board jumper settings section.

 **NOTE:** If the password jumper setting is disabled, the existing system password and setup password are deleted and you need not provide the system password to boot the system.

### Steps

1. To enter System Setup, press F2 immediately after turning on or rebooting your system.
2. On the **System Setup Main Menu** screen, click **System BIOS > System Security**.
3. On the **System Security** screen, verify that **Password Status** is set to **Unlocked**.
4. In the **System Password** field, type your system password, and press Enter or Tab.
 

Use the following guidelines to assign the system password:

  - A password can have up to 32 characters.

A message prompts you to reenter the system password.
5. Reenter the system password, and click **OK**.
6. In the **Setup Password** field, type your setup password and press Enter or Tab.
 

A message prompts you to reenter the setup password.
7. Reenter the setup password, and click **OK**.
8. Press Esc to return to the System BIOS screen. Press Esc again.
 

A message prompts you to save the changes.



 **NOTE:** Password protection does not take effect until the system reboots.

## Using your system password to secure your system

### About this task

If you have assigned a setup password, the system accepts your setup password as an alternate system password.

### Steps

1. Turn on or reboot your system.
2. Type the system password and press Enter.

### Next steps

When **Password Status** is set to **Locked**, type the system password and press Enter when prompted at reboot.

 **NOTE:** If an incorrect system password is typed, the system displays a message and prompts you to reenter your password. You have three attempts to type the correct password. After the third unsuccessful attempt, the system displays an error message that the system has stopped functioning and must be turned off. Even after you turn off and restart the system, the error message is displayed until the correct password is entered.

## Deleting or changing system and setup password

### Prerequisites

 **NOTE:** You cannot delete or change an existing system or setup password if the **Password Status** is set to **Locked**.

### Steps

1. To enter System Setup, press F2 immediately after turning on or restarting your system.
2. On the **System Setup Main Menu** screen, click **System BIOS > System Security**.
3. On the **System Security** screen, ensure that **Password Status** is set to **Unlocked**.
4. In the **System Password** field, alter or delete the existing system password, and then press Enter or Tab.
5. In the **Setup Password** field, alter or delete the existing setup password, and then press Enter or Tab.  
If you change the system and setup password, a message prompts you to reenter the new password. If you delete the system and setup password, a message prompts you to confirm the deletion.
6. Press Esc to return to the **System BIOS** screen. Press Esc again, and a message prompts you to save the changes.
7. Select **Setup Password**, change, or delete the existing setup password and press Enter or Tab.

 **NOTE:** If you change the system password or setup password, a message prompts you to reenter the new password. If you delete the system password or setup password, a message prompts you to confirm the deletion.

## Operating with setup password enabled

If **Setup Password** is set to **Enabled**, type the correct setup password before modifying the system setup options.

If you do not type the correct password in three attempts, the system displays the following message:

```
Invalid Password! Number of unsuccessful password attempts: <x> System Halted! Must power down.
```

Even after you power off and restart the system, the error message is displayed until the correct password is typed. The following options are exceptions:

- If **System Password** is not set to **Enabled** and is not locked through the **Password Status** option, you can assign a system password. For more information, see the System Security Settings screen section.
- You cannot disable or change an existing system password.

**NOTE:** You can use the password status option with the setup password option to protect the system password from unauthorized changes.

## Redundant OS Control

To view the **Redundant OS Control** screen, power on the system, press F2, and click **System Setup Main Menu > System BIOS > Redundant OS Control**.

**Table 49. Redundant OS Control details**

Option	Description
<b>Redundant OS Location</b>	Enables you to select a backup disk from the following devices: <ul style="list-style-type: none"> <li>• <b>None</b></li> <li>• <b>BOSS PCIe Cards (Internal M.2 Drives)</b></li> <li>• SATA Port A</li> </ul>
<b>Redundant OS State</b>	<p><b>NOTE:</b> This option is disabled if <b>Redundant OS Location</b> is set to <b>None</b>.</p> <p>When set to <b>Visible</b>, the backup disk is visible to the boot list and OS. When set to <b>Hidden</b>, the backup disk is disabled and is not visible to the boot list and OS. This option is set to <b>Visible</b> by default.</p> <p><b>NOTE:</b> BIOS disables the device in hardware, so it is not accessed by the OS.</p>
<b>Redundant OS Boot</b>	<p><b>NOTE:</b> This option is disabled if <b>Redundant OS Location</b> is set to <b>None</b> or if <b>Redundant OS State</b> is set to <b>Hidden</b>.</p> <p>When set to <b>Enabled</b>, BIOS boots to the device specified in <b>Redundant OS Location</b>. When set to <b>Disabled</b>, BIOS preserves the current boot list settings. This option is set to <b>Disabled</b> by default.</p>

## Miscellaneous Settings

To view the **Miscellaneous Settings** screen, power on the system, press F2, and click **System Setup Main Menu > System BIOS > Miscellaneous Settings**.

**Table 50. Miscellaneous Settings details**

Option	Description
<b>System Time</b>	Enables you to set the time on the system.
<b>System Date</b>	Enables you to set the date on the system.
<b>Time Zone</b>	Enables you to select required Time Zone.
<b>Daylight Savings Time</b>	Enables or disables Daylight Savings Time. This option is set to <b>Disabled</b> by default.
<b>Asset Tag</b>	Specifies the asset tag and enables you to modify it for security and tracking purposes.
<b>Keyboard NumLock</b>	Enables you to set whether the system boots with the NumLock enabled or disabled. This option is set to <b>On</b> by default. <b>NOTE:</b> This option does not apply to 84-key keyboards.
<b>F1/F2 Prompt on Error</b>	Enables or disables the F1/F2 prompt on error. This option is set to <b>Enabled</b> by default. The F1/F2 prompt also includes keyboard errors.
<b>Dell Wyse P25/P45 BIOS Access</b>	Enables or disables the Dell Wyse P25/P45 BIOS Access. This option is set to <b>Enabled</b> by default.
<b>Power Cycle Request</b>	Enables or disables the Power Cycle Request. This option is set to <b>None</b> by default.

# Dell Lifecycle Controller

Dell Lifecycle Controller (LC) provides advanced embedded systems management capabilities including system deployment, configuration, update, maintenance, and diagnosis. LC is delivered as part of the iDRAC out-of-band solution and Dell system embedded Unified Extensible Firmware Interface (UEFI) applications.

## Embedded system management

The Dell Lifecycle Controller provides advanced embedded system management throughout the lifecycle of the system. The Dell Lifecycle Controller is started during the boot sequence and functions independently of the operating system.

 **NOTE:** Certain platform configurations may not support the full set of features provided by the Dell Lifecycle Controller.

For more information about setting up the Dell Lifecycle Controller, configuring hardware and firmware, and deploying the operating system, see the Dell Lifecycle Controller documentation at [iDRAC Manuals](#).

## Boot Manager

The **Boot Manager** option enables you to select boot options and diagnostic utilities.

To enter **Boot Manager**, power on the system and press F11.

**Table 51. Boot Manager details**

Option	Description
<b>Continue Normal Boot</b>	The system attempts to boot to devices starting with the first item in the boot order. If the boot attempt fails, the system continues with the next item in the boot order until the boot is successful or no more boot options are found.
<b>One-shot UEFI Boot Menu</b>	Enables you to access boot menu, where you can select a one-time boot device to boot from.
<b>Launch System Setup</b>	Enables you to access System Setup.
<b>Launch Lifecycle Controller</b>	Exits the Boot Manager and invokes the Dell Lifecycle Controller program.
<b>System Utilities</b>	Enables you to launch System Utilities menu such as Launch Diagnostics, BIOS update File Explorer, Reboot System.

## PXE boot

You can use the Preboot Execution Environment (PXE) option to boot and configure the networked systems remotely.

To access the **PXE boot** option, boot the system and then press F12 during POST instead of using standard Boot Sequence from BIOS Setup. It does not pull any menu or allows managing of network devices.

# Minimum to POST

This section describes the minimum to POST system requirement of the Dell system.

## Topics:

- [Minimum configuration to POST](#)
- [Configuration validation](#)

## Minimum configuration to POST

The components that are listed below are the minimum configuration to POST:

- Processor
- One memory module (DIMM) in slot A1
- One power supply unit in PSU 1
- Power Interposer Board (PIB)
- System board + FIO card (Right control panel)

## Configuration validation

The new generation of Dell systems have added interconnect flexibility and advanced iDRAC management features to collect precise system configuration information and report configuration errors.

When the system is powered on, information about installed cables, risers, backplanes, power supplies, floating card (fPERC, adapter PERC , BOSS), and processor is obtained from the CPLD and backplane memory maps are analyzed. This information forms a unique configuration, which is compared with one of the qualified configurations that are stored in a table that is maintained by iDRAC.

One or more sensors are assigned to each of the configuration elements. During POST, any configuration validation error is logged in the System Event Log (SEL)/LifeCycle (LC) log. The reported events are categorized in the configuration validation error table.

**Table 52. Configuration validation error**

Error	Description	Possible cause and recommendations	Example
Config Error	A configuration element within the closest match contains something that is unexpected and does not match any Dell qualified configuration.	Wrong configuration	Config Error: Backplane cable CTRS_SRC_SA1 and BP-DST_SA1
		The element reported in HWC8010 errors are assembled incorrectly. Verify element (cable, risers, etc) placement in the system.	Config Error : SL Cable PLANAR_SL7 and CTRL_DST_PA1
Config Missing	iDRAC found a configuration element missing within the closest match detected.	Missing or damaged cable, device, or part	Config Missing: Float card front PERC/HBAadapter PERC/HBA
		Missing element or cable is reported in HWC8010 error logs. Install the missing element (cable, risers, etc).	Config Missing : SL cable PLANAR_SL8 and CTRL_DST_PA1

**Table 52. Configuration validation error (continued)**

Error	Description	Possible cause and recommendations	Example
Comm Error	A configuration element is not responding to iDRAC using the management interface while running an inventory check.	System management sideband communication Unplug AC Power, reset the element and replace the element if the problem persists.	Comm Error: Backplane 2

## Error messages

This section describes the error messages that are displayed on the screen during POST or captured in the system event log (SEL)/LifeCycle (LC) log.

**Table 53. Error message HWC8010**

Error code	HWC8010
Message	The System Configuration Check operation that is resulted in the following issue involving the indicated component type
Arguments	Riser, floating card (fPERC, adapter PERC, BOSS), backplane, processor, cable, or other components
Detailed Description	The issue that is identified in the message is observed in the System Configuration Check operation.
Recommended Response Action	Do the following and retry the operation: <ol style="list-style-type: none"> <li>1. Disconnect the input power.</li> <li>2. Check for proper cable connection and component placement. If the issue persists, contact the service provider.</li> </ol>
Category	System Health (HWC = Hardware Config)
Severity	Critical
Trap/EventID	2329

**Table 54. Error message HWC8011**

Error code	HWC8011
Message	The System Configuration Check operation that is resulted in multiple issues involving the indicated component type
Arguments	Riser, floating card (fPERC, adapter PERC, BOSS), backplane, processor, cable, or other components
Detailed Description	Multiple issues are observed in the System Configuration Check operation.
Recommended Response Action	Do the following and retry the operation: <ol style="list-style-type: none"> <li>1. Disconnect the input power.</li> <li>2. Check for proper cable connection and component placement. If the issue persists, contact the service provider.</li> </ol>
Category	System Health (HWC = Hardware Config)
Severity	Critical

# Installing and removing system components

## Topics:

- Safety instructions
- Before working inside your system
- After working inside your system
- Recommended tools
- Optional front bezel
- System cover
- Air shroud
- Cooling fans
- Intrusion switch
- Drive backplane
- Cable routing
- Drives
- System memory
- Processor and heat sink module
- Expansion cards and expansion card risers
- Optional BOSS-N1 module
- System battery
- PERC card
- Power supply units
- Power interposer board (PIB)
- System board
- Trusted Platform Module
- Control panel

## Safety instructions

### Before working inside your system

#### Prerequisites

Follow the safety guidelines listed in the [Safety instructions](#).

#### Steps

1. Power off the system and all attached peripherals.
2. Disconnect the system from the electrical outlet and disconnect the peripherals.
3. If applicable, remove the system from the rack.  
For more information, see the *Rail Installation Guide* relevant to your rail solutions at [PowerEdge Manuals](#).
4. Remove the system cover.

### After working inside your system

#### Prerequisites

Follow the safety guidelines listed in [Safety instructions](#).

## Steps

1. Replace the system cover.
2. If applicable, install the system into the rack.  
For more information, see the *Rail Installation Guide* relevant to your system at [PowerEdge Manuals](#).
3. Reconnect the peripherals and connect the system to the electrical outlet, and then power on the system.

## Recommended tools

You may need some or all of the following tools to perform the removal and installation procedures:

- Key to the bezel lock. The key is required only if your system includes a bezel.
- Phillips 1 screwdriver
- Phillips 2 screwdriver
- Torx T15 screwdriver
- 5 mm hex nut screwdriver
- Plastic scribe
- 1/4-inch flat blade screwdriver
- Wrist grounding strap connected to the ground
- ESD mat
- Needle-nose pliers

## Optional front bezel

### Removing the front bezel

#### Prerequisites

1. Follow the safety guidelines listed in [Safety instructions](#).
2. Follow the procedure listed in [Before working on your system](#).
3. If installed, remove the system from the rack and place it on an ESD work bench. For more information, see the *Rail Installation Guide* at [PowerEdge manuals](#).
4. Keep the bezel key handy.

 **NOTE:** The bezel key is part of the LCD bezel package.

#### Steps

1. Unlock the bezel.
2. Press the release button, and disengage the left end of the bezel.
3. Unhook the right end, and remove the bezel.

 **NOTE:** The numbers on the image do not depict the exact steps. The numbers are for representation of sequence.

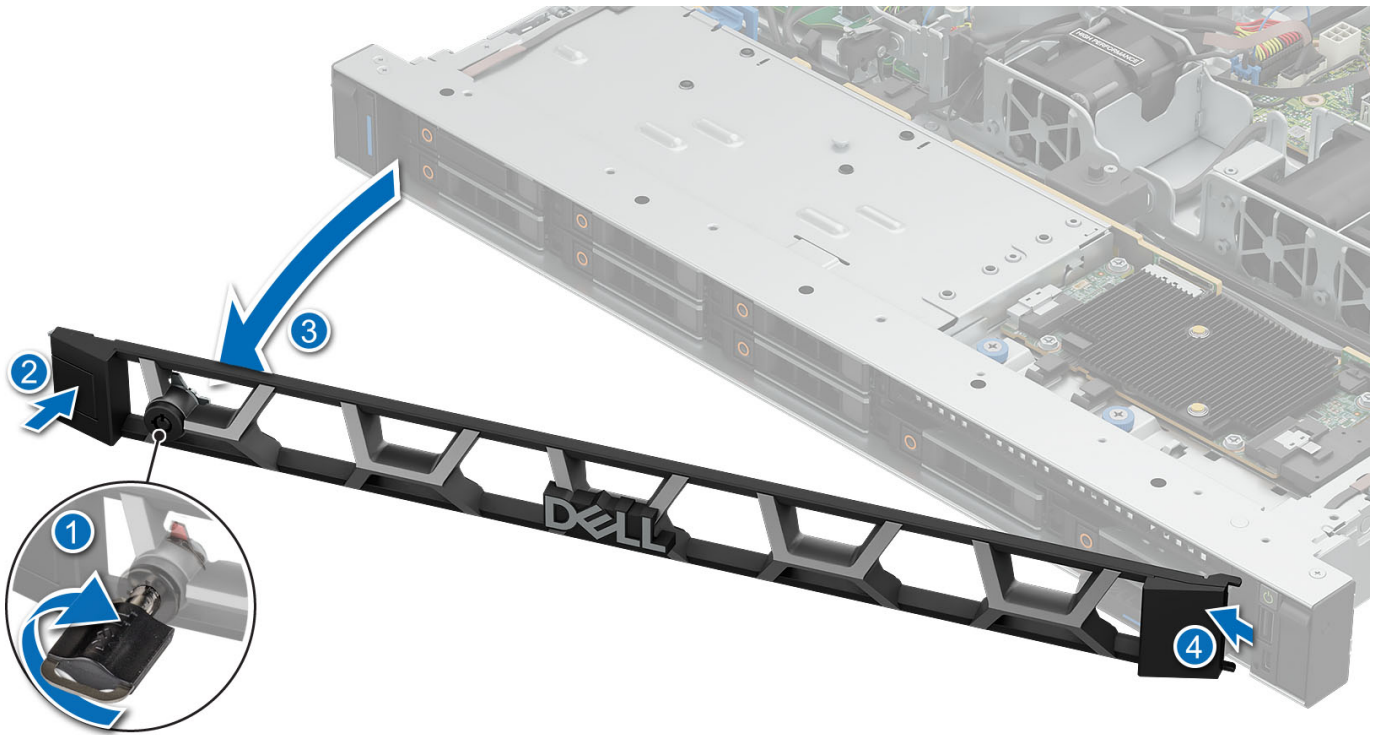

Figure 14. Removing the front bezel

#### Next steps

installing the front bezel.

## Installing the front bezel

#### Prerequisites

1. Follow the safety guidelines listed in [Safety instructions](#).
2. Follow the procedure listed in [Before working on your system](#).

#### Steps

1. Align and insert the tabs on the bezel into the slots on the system.
2. Press the bezel until the release button clicks in place.
3. Lock the bezel.

**NOTE:** The numbers on the image do not depict the exact steps. The numbers are for representation of sequence.



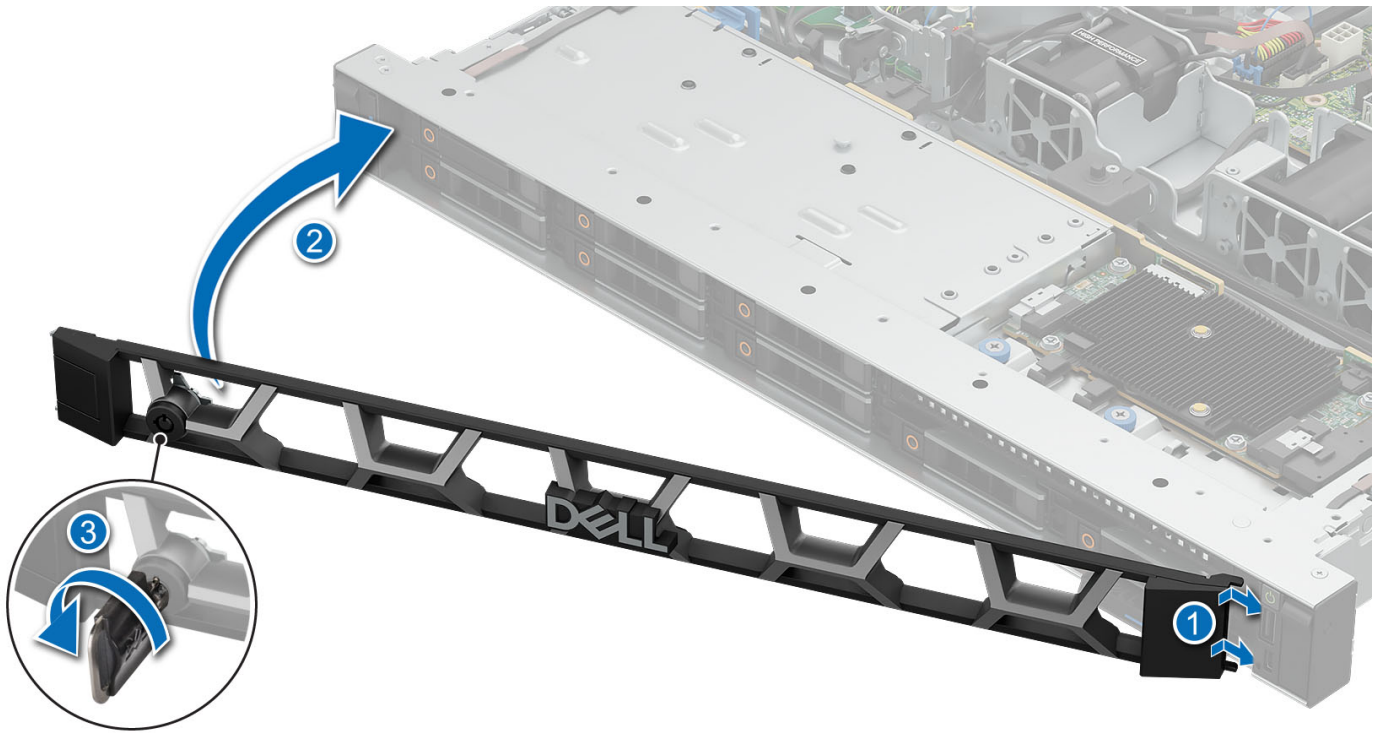

Figure 15. Installing the front bezel

#### Next steps

1. Follow the procedure listed in [After working inside your system](#).

## System cover

### Removing the system cover

#### Prerequisites

1. Follow the safety guidelines listed in [Safety instructions](#).
2. Follow the procedure listed in [Before working on your system](#).

#### Steps

1. Using a 1/4-inch flat head or Phillips #2 screwdriver, rotate the lock counterclockwise to the unlock position.
2. Lift the release latch until the system cover slides back.
3. Lift the cover from the system.

**NOTE:** The numbers on the image do not depict the exact steps. The numbers are for representation of sequence.



**Figure 16. Removing the system cover**

#### **Next steps**

1. [Install the system cover.](#)

## **Installing the system cover**

#### **Prerequisites**

1. Follow the safety guidelines listed in [Safety instructions](#).
2. Follow the procedure listed in [Before working on your system](#).

#### **Steps**

1. Align the tabs on the system cover with the guide slots on the system.
2. Close the system cover release latch.
3. Using a 1/4-inch flat head or Phillips #2 screwdriver, rotate the lock clockwise to the lock position.

**NOTE:** The numbers on the image do not depict the exact steps. The numbers are for representation of sequence.



**Figure 17. Installing system cover**

**Next steps**

1. Follow the procedure listed in [After working inside your system.](#)

# Air shroud

## Removing the air shroud

### Prerequisites

**CAUTION:** Never operate your system with the air shroud removed. The system may get overheated quickly, resulting in shutdown of the system and loss of data.

1. Follow the safety guidelines listed in [Safety instructions](#).
2. Follow the procedure listed in [Before working on your system](#).
3. [Remove the system cover](#).

### Steps

Hold the air shroud at both ends and lift the air shroud out of the system.

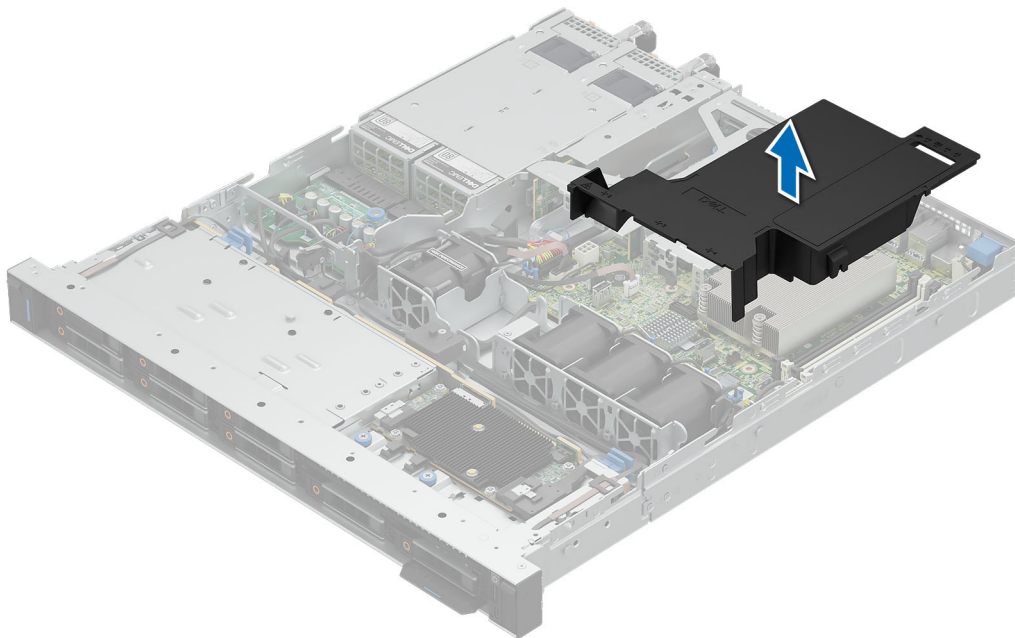

Figure 18. Removing air shroud

### Next steps

[Install the air shroud](#).

## Installing the air shroud

### Prerequisites

1. Follow the safety guidelines listed in [Safety instructions](#).
2. Follow the procedure listed in [Before working on your system](#).
3. [Remove the system cover](#).

### Steps

1. Align the air shroud with the standoff on the chassis wall.

**NOTE:** Route the cable properly to prevent the cable from being pinched or crimped.

2. Lower the air shroud into the system until it is firmly seated.

**NOTE:** The numbers on the image do not depict the exact steps. The numbers are for representation of sequence.

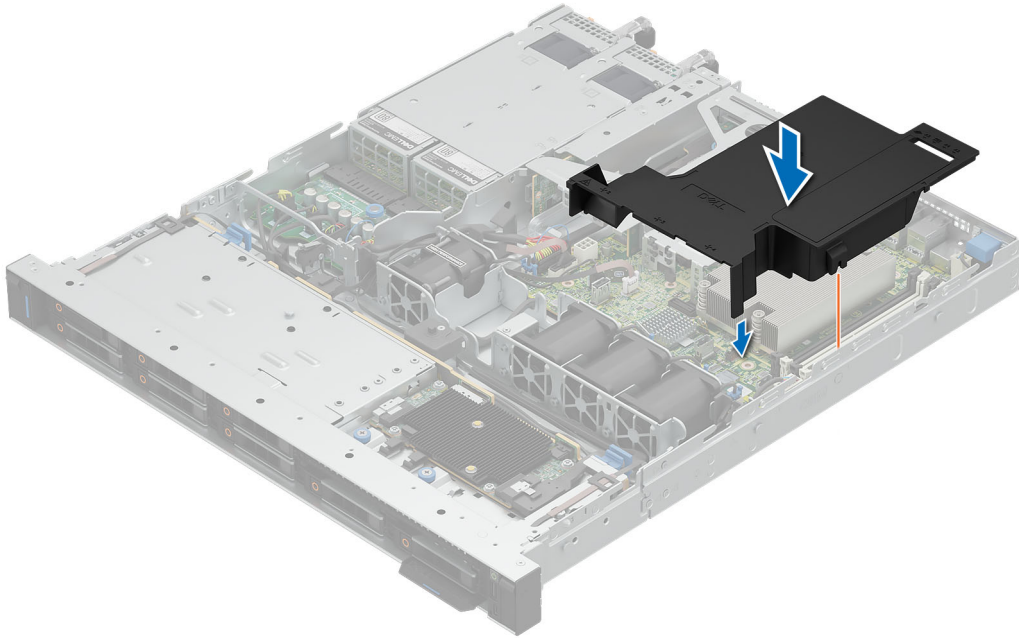

**Figure 19. Installing air shroud**

#### Next steps

1. [Install the system cover.](#)
2. Follow the procedure listed in [After working inside your system.](#)

## Cooling fans

### Removing the cooling fan

#### Prerequisites

1. Follow the safety guidelines listed in [Safety instructions.](#)
2. Follow the procedure listed in [Before working on your system.](#)
3. [Remove air shroud.](#)

#### Steps

1. Press the release tabs on the fan cable connector and disconnect the cable from the system board.
2. Lift the cooling fan from the cooling fan cage.

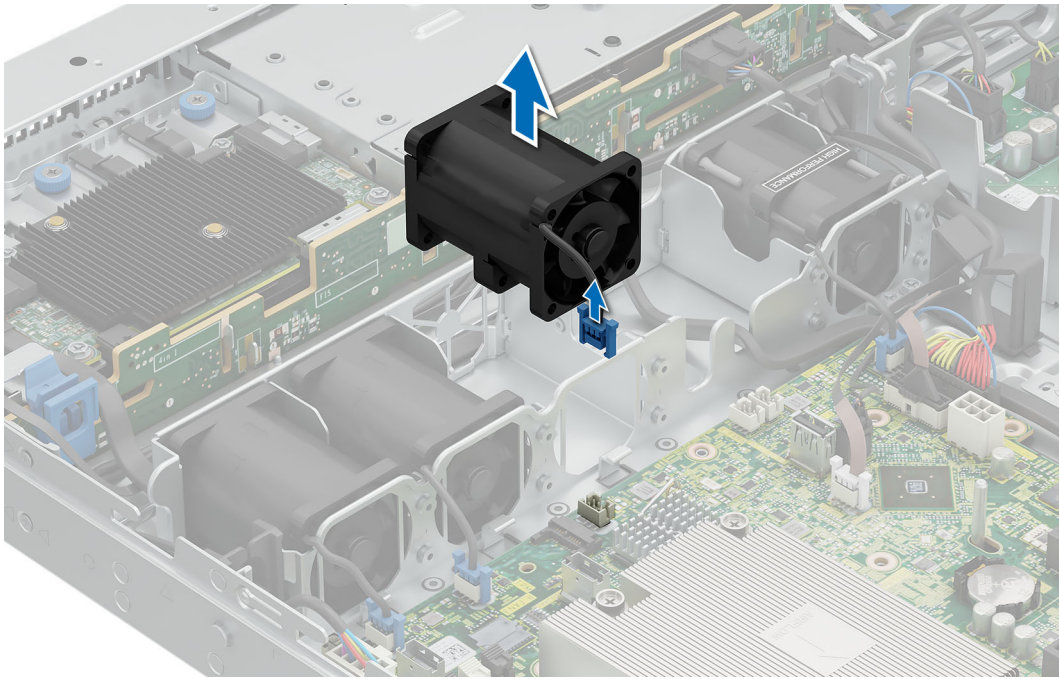

**Figure 20. Removing cooling fan**

#### **Next steps**

1. [Install the cooling fan.](#)
2. Follow the procedure listed in [After working inside your system.](#)

## **Installing a cooling fan**

#### **Prerequisites**

1. Follow the safety guidelines listed in [Safety instructions.](#)
2. Follow the procedure listed in [Before working on your system.](#)
3. [Remove air shroud.](#)

#### **Steps**

1. Lower the cooling fan into the cage until it is seated firmly.
2. Press the release tabs on the fan cable connector and connect the cable to the system board.



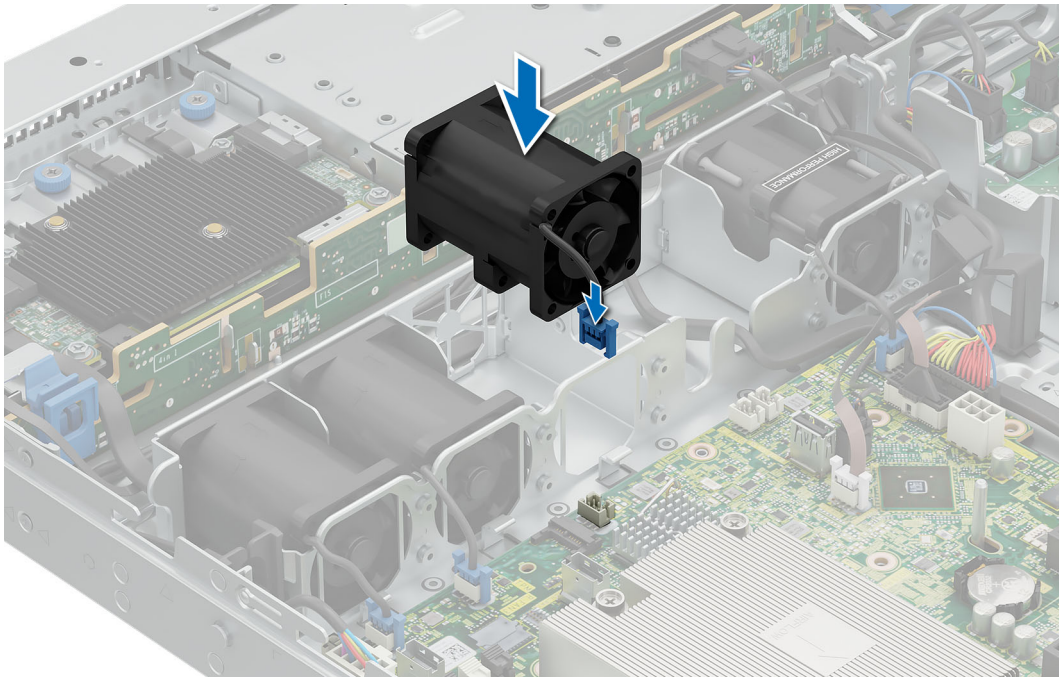

**Figure 21. Installing a cooling fan**

#### Next steps

1. [Install the air shroud.](#)
2. Follow the procedure listed in [After working inside your system.](#)

## Intrusion switch

### Removing the intrusion switch

#### Prerequisites

1. Follow the safety guidelines listed in [Safety instructions.](#)
2. Follow the procedure listed in [Before working on your system.](#)
3. [Remove air shroud.](#)

#### Steps

1. Disconnect and remove the intrusion switch cable from the system board.  
**i** **NOTE:** Observe the routing of the cable as you remove it from the system. Route the cable properly when you replace it to prevent the cable from being pinched or crimped.
2. Loosen and remove the single screw to remove the intrusion switch from the chassis.  
**i** **NOTE:** The numbers on the image do not depict the exact steps. The numbers are for representation of sequence.

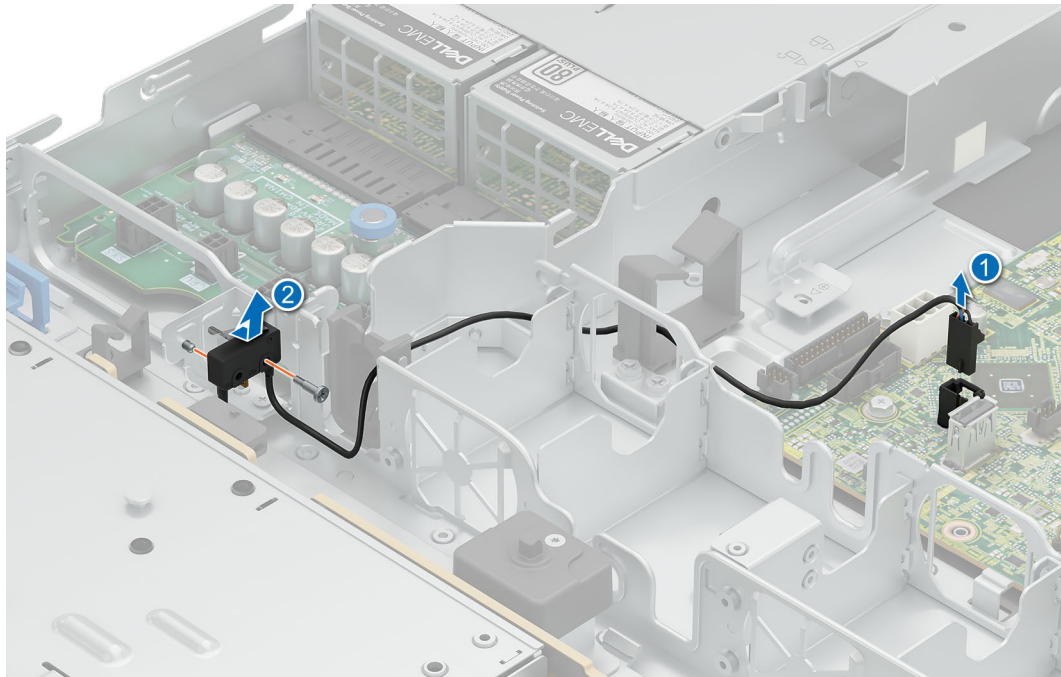

**Figure 22. Removing the intrusion switch**

### Next steps

1. [Install the intrusion switch.](#)
2. Follow the procedure listed in [After working inside your system.](#)

## Installing the intrusion switch

### Prerequisites

1. Follow the safety guidelines listed in [Safety instructions.](#)
2. Follow the procedure listed in [Before working on your system.](#)
3. [Remove system cover.](#)
4. [Remove air shroud.](#)

### Steps

1. Align and slide the intrusion switch into the guide pin on the chassis.
2. Tighten the screw to secure the intrusion switch to the chassis.

**NOTE:** The numbers on the image do not depict the exact steps. The numbers are for representation of sequence.



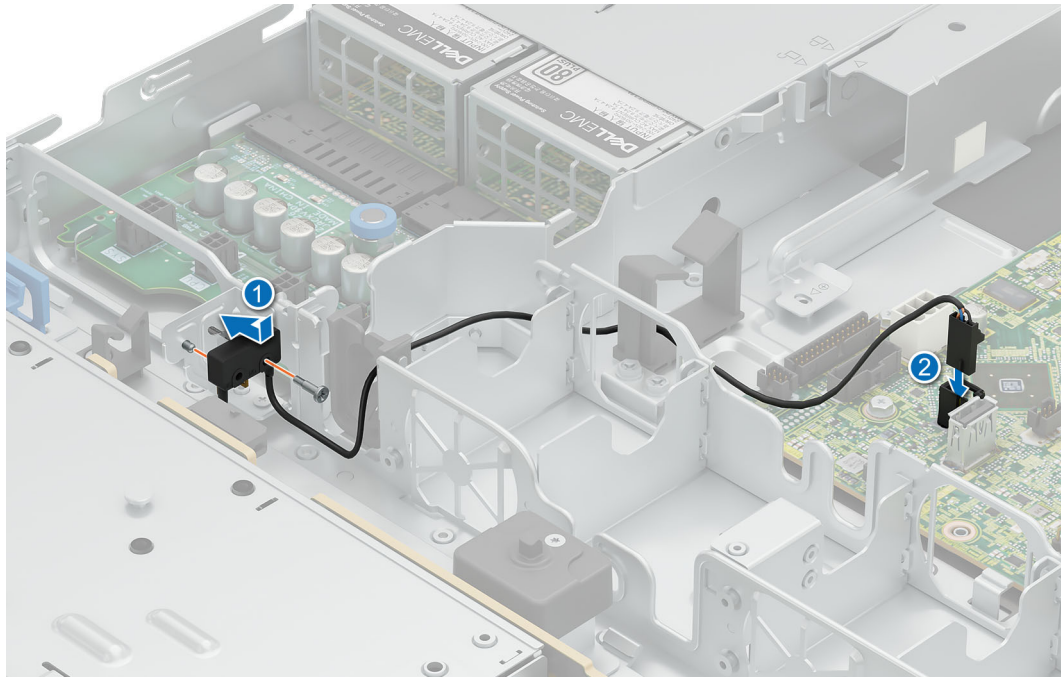

**Figure 23. Installing the intrusion switch**

3. Connect the intrusion switch cable to the connector on the system board.

**NOTE:** Route the cable properly when you replace it to prevent the cable from being pinched or crimped.

**Next steps**

1. [Install the air shroud.](#)
2. Follow the procedure listed in [After working inside your system.](#)

## Drive backplane

This is a service technician replaceable part only.

### Drive backplane guidelines

Depending on your system configuration, the drive backplanes supported in PowerEdge R360 are listed here:

**Table 55. Supported backplane options for PowerEdge R360 system**

System	Supported backplane options
PowerEdge R360	2.5-inch (x8) SAS/SATA/SSD backplane
	3.5-inch (x4) SAS/SATA/SSD backplane

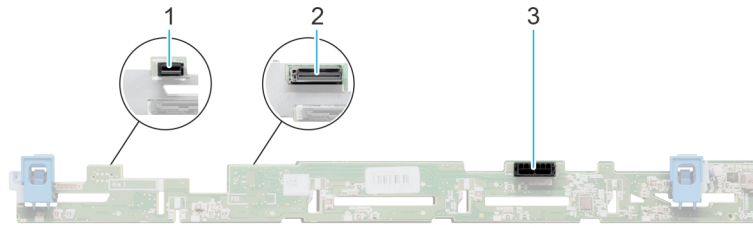

**Figure 24. 8 x 2.5-inch SAS/SATA/SSD drive backplane**

1. BP\_PWR\_CTRL (backplane power)
2. BP\_DST\_SA1 (SAS/SATA connector)
3. BP\_PWR\_1 (backplane power and signal cable to PIB)

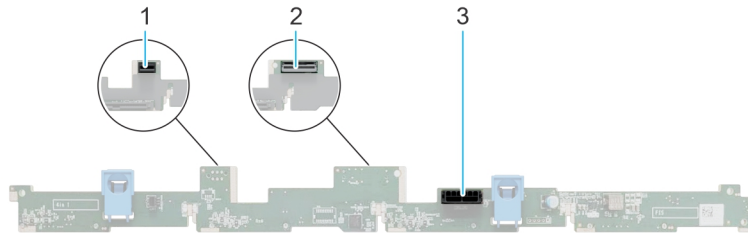

**Figure 25. 4 x 3.5-inch SAS/SATA/SSD drive backplane**

1. BP\_PWR\_CTRL (backplane power)
2. BP\_DST\_SA1 (SAS/SATA connector)
3. BP\_PWR\_1 (backplane power and signal cable to PIB)

## Removing the front drive bay backplane

### Prerequisites

**CAUTION:** Note the number of each drive and temporarily label them before you remove the drive so that you can replace them in the same location.

1. Follow the safety guidelines listed in [Safety instructions](#).
2. Follow the procedure listed in [Before working on your system](#).
3. [Remove the drives](#).
4. Disconnect the cables from the backplane.
  - NOTE:** Observe the routing of the cable as you remove it from the system. Route the cable properly when you replace it to prevent the cable from being pinched or crimped.

### Steps

1. Press the blue release tabs to disengage the drive backplane from the hooks on the system.
2. Lift the drive backplane out of the system.
  - NOTE:** The numbers on the image do not depict the exact steps. The numbers are for representation of sequence.

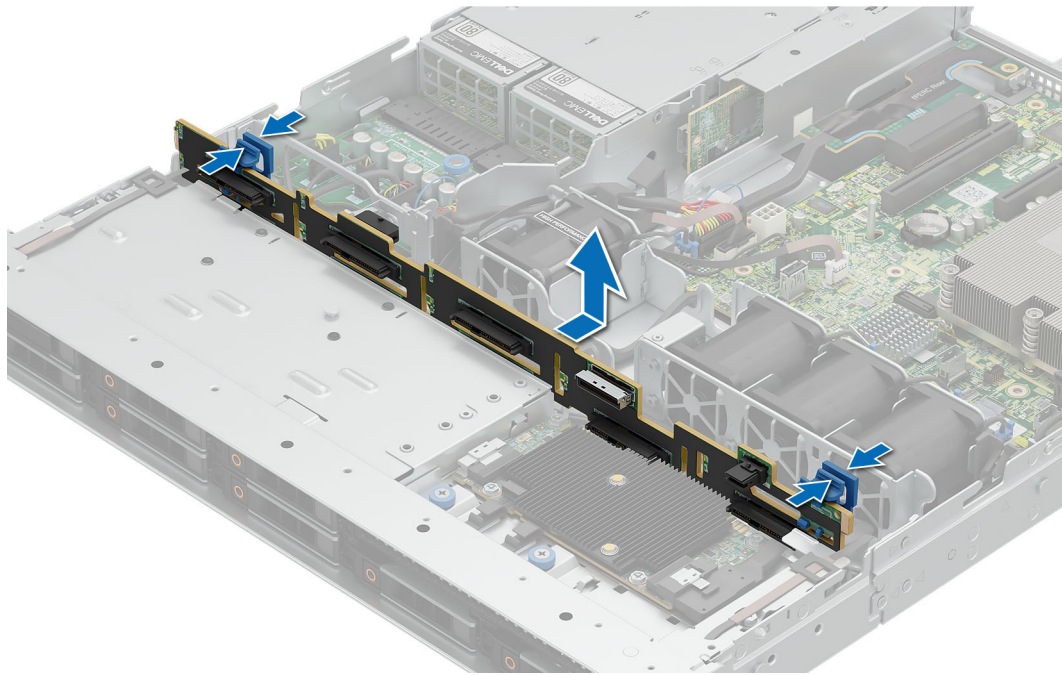

**Figure 26. Removing front drive bay backplane**

**NOTE:** To avoid damaging the backplane, ensure that you move the control panel cables from the cable routing clips before removing the backplane.

#### Next steps

Install the backplane.

## Installing the front drive bay backplane

#### Prerequisites

1. Follow the safety guidelines listed in [Safety instructions](#).
2. Follow the procedure listed in [Before working on your system](#).
3. [Remove the drives](#).
4. Disconnect the cables from the backplane.

**NOTE:** To avoid damaging the backplane, ensure to move the control panel cables from the cable routing clips before removing the backplane.

**NOTE:** Route the cable properly when you replace it to prevent the cable from being pinched or crimped.

#### Steps

1. Align the backplane to the guide hooks on the system.
2. Insert the backplane into the hooks till the blue release tabs click in place.

**NOTE:** The numbers on the image do not depict the exact steps. The numbers are for representation of sequence.

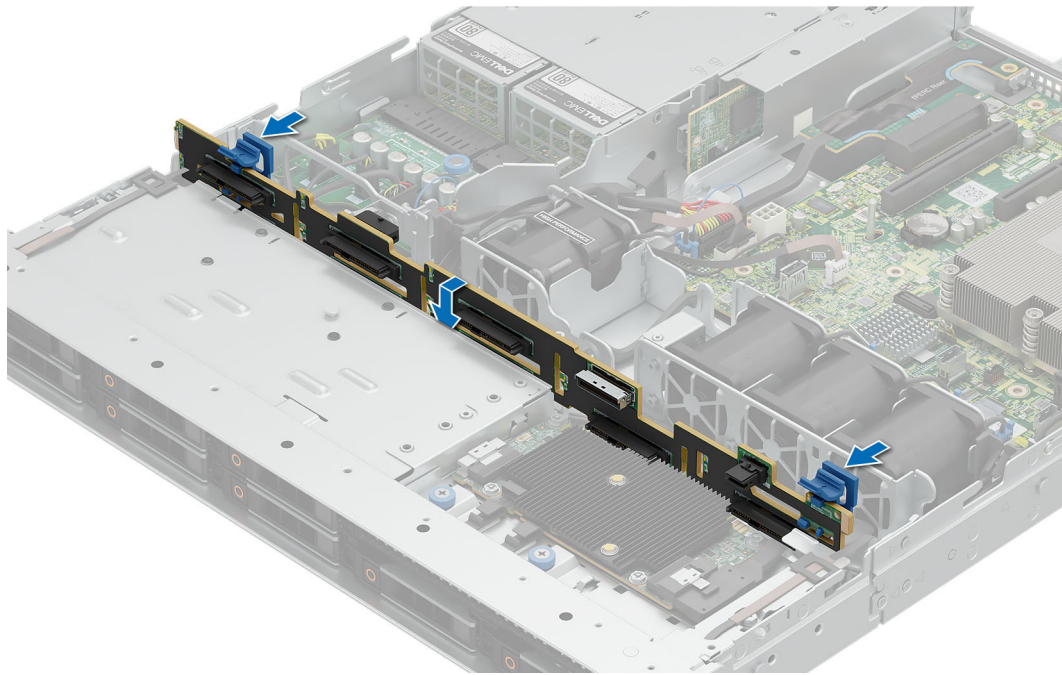

Figure 27. Installing front drive bay backplane

**Next steps**

1. Connect all the cables to the backplane.
2. [Install the drives](#) back into their original locations.
3. Follow the procedure listed in [After working inside your system](#).

## Cable routing

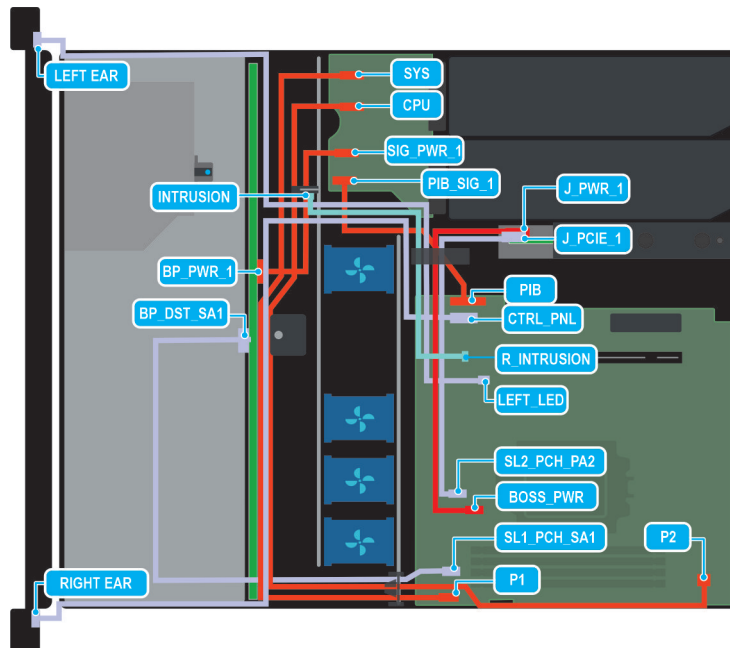
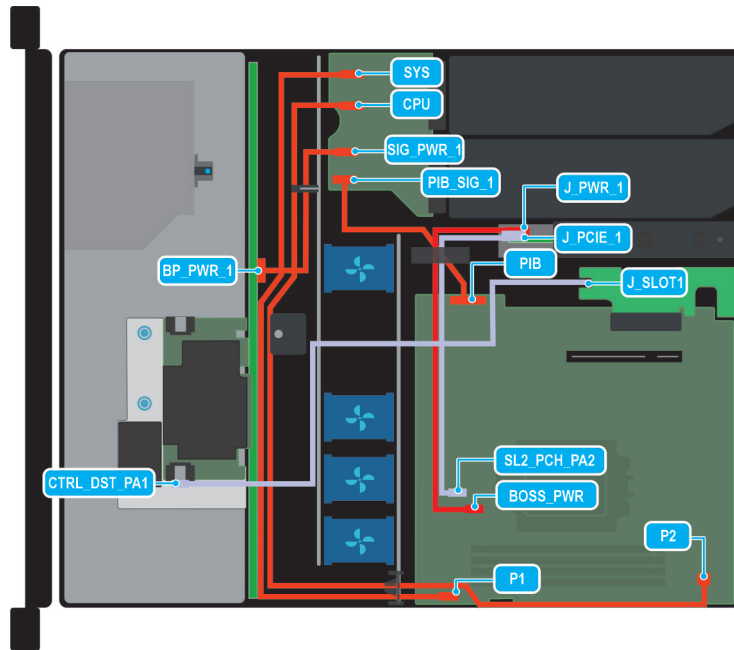

Figure 28. Configuration 0: 4 x 3.5 inch SATA with BOSS N1 (optopnal)

**NOTE:** Follow the sequential order as shown in the table to remove the cables, to install the cables follow the reverse sequential order.

**Table 56. Connector descriptions for 4 x 3.5 inch SATA with BOSS N1 (optional)**

Order	From	To
1	SL1_PCH_SA1 (system board signal connector)	BP_DST_SA1 (backplane signal connector)
2	PIB (system board connector)	PIB_SIG_1 (PIB signal connector)
3	P1 (system board power connector)	SYS (PIB power connector)
4	P2 (system board power connector)	CPU (PIB power connector)
5	SIG_PWR_1(PIB power connector)	BP_PWR_1 (backplane power connector)
6	CTRL_PNL (system board control panel connector)	Right Ear
7	LEFT_LED (system board control panel connector)	Left Ear
8	R_INTRUSION (system board intrusion switch connector)	Intrusion switch
9	SL2_PCH_PA2 (system board signal connector)	J_PCIE_1 (BOSS N1 signal connector)
10	MB_BOSS_PWR (System board power connector)	J_PWR_1 (BOSS N1 power connector)



**Figure 29. Configuration 1: 4 x 3.5 inch SAS/SATA and fPERC with BOSS N1 (optional)**

**NOTE:** Follow the sequential order as shown in the table to remove the cables, to install the cables follow the reverse sequential order.

**Table 57. Connector descriptions for 4 x 3.5 inch SAS/SATA and fPERC with BOSS N1 (optional)**

Order	From	To
1	J_SLOT1 (fPERC Riser)	CTRL_DST_PA1 (fPERC connector)

**Table 57. Connector descriptions for 4 x 3.5 inch SAS/SATA and fPERC with BOSS N1 (optional) (continued)**

Order	From	To
2	PIB (system board connector)	PIB_SIG_1 (PIB signal connector)
3	P1 (system board power connector)	SYS (PIB power connector)
4	P2 (system board power connector)	CPU (PIB power connector)
5	SIG_PWR_1(PIB power connector)	BP_PWR_1 (backplane power connector)
6	SL2_PCH_PA2 (system board signal connector)	J_PCIE_1 (BOSS N1 signal connector)
7	MB_BOSS_PWR (System board power connector)	J_PWR_1 (BOSS N1 power connector)

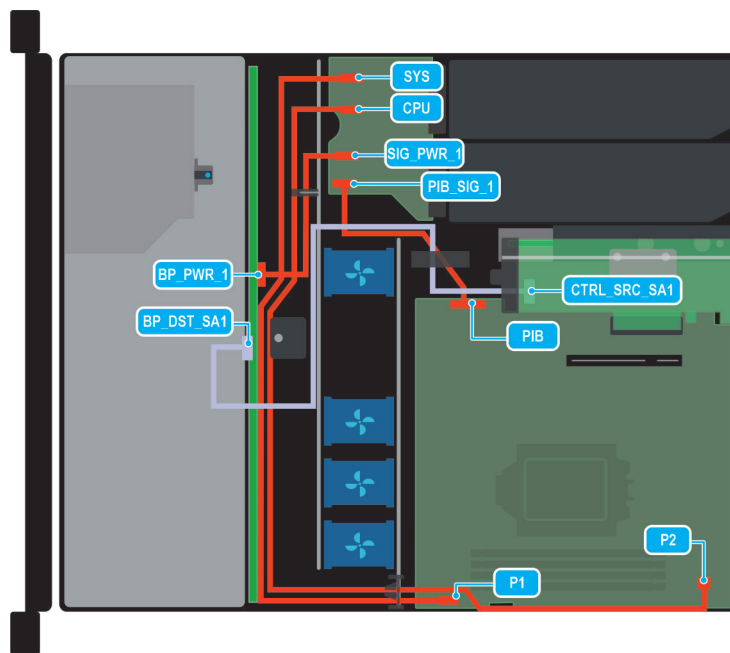
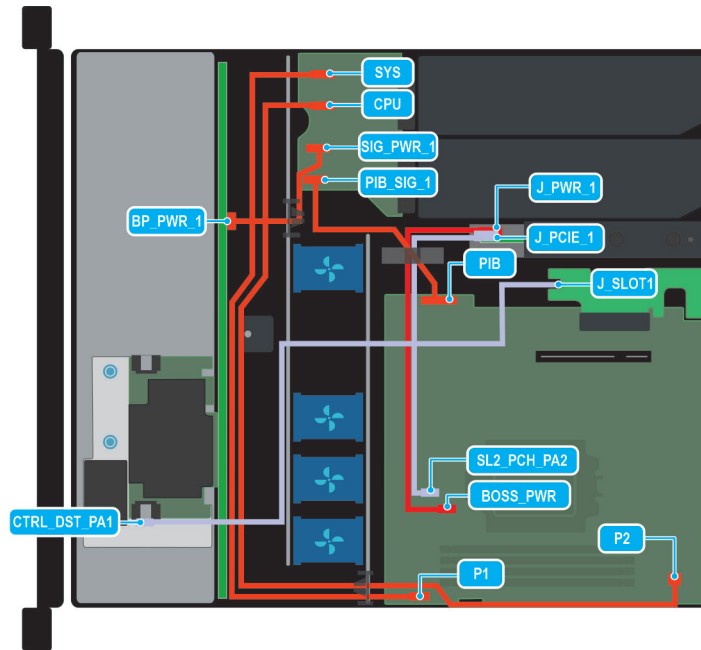

**Figure 30. Configuration 2: 4 x 3.5 inch SAS/SATA and internal PERC card**

**NOTE:** Follow the sequential order as shown in the table to remove the cables, to install the cables follow the reverse sequential order.

**Table 58. Connector descriptions for 4 x 3.5 inch SAS/SATA and internal PERC card**

Order	From	To
1	CTRL_SRC_SA1 (adapter PERC controller connector)	BP_DST_SA1 (backplane signal connector)
2	PIB (system board connector)	PIB_SIG_1 (PIB signal connector)
3	P1 (system board power connector)	SYS (PIB power connector)
4	P2 (system board power connector)	CPU (PIB power connector)
5	SIG_PWR_1(PIB power connector)	BP_PWR_1 (backplane power connector)



**Figure 31. Configuration 3: -8 x 2.5 inch SAS/SATA and fPERC card with optional BOSS N1**

**NOTE:** Follow the sequential order as shown in the table to remove the cables, to install the cables follow the reverse sequential order.

**Table 59. Connector descriptions for 8 x 2.5 inch SAS/SATA and fPERC card with optional BOSS N1**

Order	From	To
1	J_SLOT1 (fPERC Riser)	CTRL_DST_PA1 (fPERC connector)
2	PIB (system board connector)	PIB_SIG_1 (PIB signal connector)
3	P1 (system board power connector)	SYS (PIB power connector)
4	P2 (system board power connector)	CPU (PIB power connector)
5	SIG_PWR_1(PIB power connector)	BP_PWR_1 (backplane power connector)
6	SL2_PCH_PA2 (system board signal connector)	J_PCIE_1 (BOSS N1 signal connector)
7	MB_BOSS_PWR (System board power connector)	J_PWR_1 (BOSS N1 power connector)



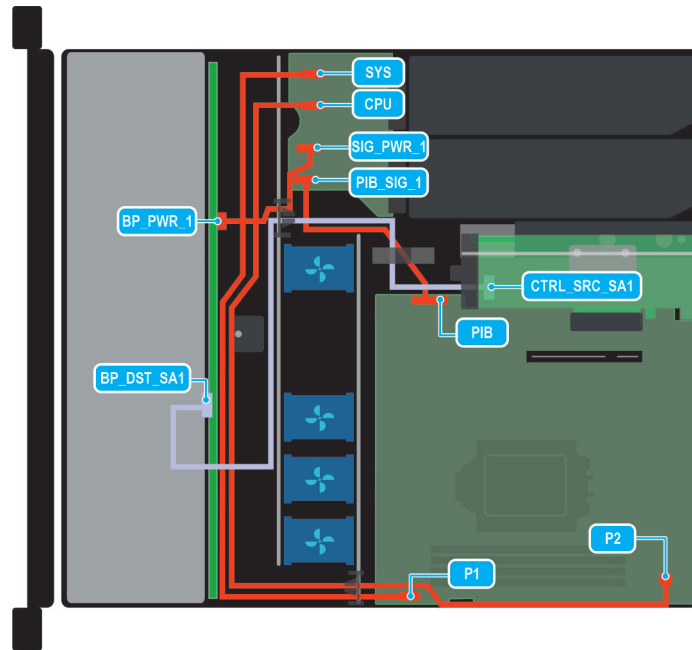

Figure 32. Configuration 4: - 8 x 2.5 inch SAS/SATA and internal PERC card

**NOTE:** Follow the sequential order as shown in the table to remove the cables, to install the cables follow the reverse sequential order.

Table 60. Connector descriptions for 8 x 2.5 inch SAS/SATA and internal PERC card

Order	From	To
1	CTRL_SRC_SA1 (adapter PERC controller connector)	BP_DST_SA1 (backplane signal connector)
2	PIB (system board connector)	PIB_SIG_1 (PIB signal connector)
3	P1 (system board power connector)	SYS (PIB power connector)
4	P2 (system board power connector)	CPU (PIB power connector)
5	SIG_PWR_1(PIB power connector)	BP_PWR_1 (backplane power connector)

**NOTE:** Follow the sequential order as shown in the table to remove the cables, to install the cables follow the reverse sequential order.

## Drives

### Removing a drive blank

#### Prerequisites

1. Follow the safety guidelines listed in [Safety instructions](#).
2. Follow the procedure listed in [Before working on your system](#).

**CAUTION:** To maintain proper system cooling, drive blanks must be installed in all empty drive slots.

**CAUTION:** Mixing drive blanks from previous generations of PowerEdge servers is not supported.



### Steps

Press the release button, and slide the drive blank out of the drive slot.

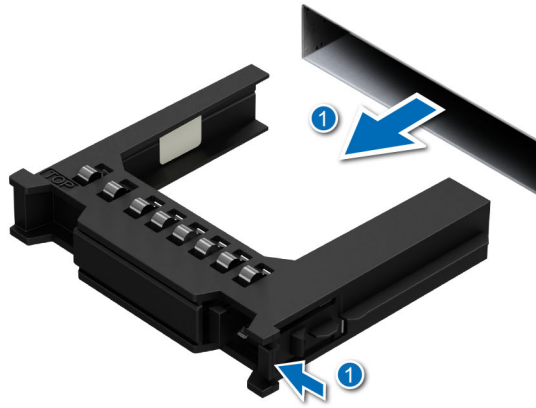

Figure 33. Removing a drive blank

### Next steps

Install the hard drive blank.

## Installing a drive blank

### Prerequisites

1. Follow the safety guidelines listed in [Safety instructions](#).
2. Follow the procedure listed in [Before working on your system](#).

**CAUTION:** To maintain proper system cooling, drive blanks must be installed in all empty drive slots.

**CAUTION:** Mixing drive blanks from previous generations of PowerEdge servers is not supported.

### Steps

Insert the drive blank into the drive slot, and push the blank until the release button clicks into place.

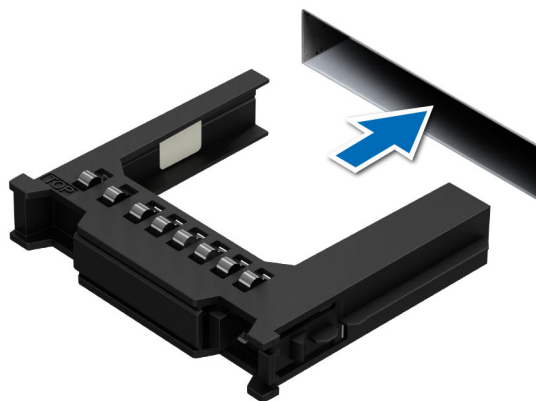

Figure 34. Installing a drive blank

## Removing a drive carrier

### Prerequisites

1. Follow the safety guidelines listed in [Safety instructions](#).
2. Follow the procedure listed in [Before working on your system](#).
3. Using the management software, prepare the drive for removal.
  - NOTE:** If the drive is online, the green activity or fault indicator flashes while the drive is turning off. When the drive indicators are off, the drive is ready for removal. For more information, see the documentation for the storage controller.

**CAUTION:** Before attempting to remove or install a drive while the system is running, see the documentation for the storage controller card to ensure that the host adapter is configured correctly to support drive removal and insertion.

**CAUTION:** Mixing drives from previous generations of PowerEdge servers is not supported.

**CAUTION:** To prevent data loss, ensure that your operating system supports drive installation. See the documentation supplied with your operating system.

### Steps

1. Press the release button to open the drive carrier release handle.
2. Holding the handle, slide the drive carrier out of the drive slot.
  - NOTE:** The numbers on the image do not depict the exact steps. The numbers are for representation of sequence.



Figure 35. Removing a drive carrier

### Next steps

1. [Install the drive carrier](#).
2. If you are not replacing the drive immediately, [Install the hard drive blank](#) in the empty drive slot to maintain proper system cooling.

## Removing the drive from the drive carrier

### Prerequisites

**CAUTION:** Mixing drives from previous generations of PowerEdge servers is not supported.

## Steps

1. Using a Phillips #1 screwdriver, remove the screws from the slide rails on the drive carrier.  
**i** **NOTE:** If the hard drive or SSD carrier has a Torx screw, use Torx 6 (for 2.5-inch drive) or Torx 8 (for 3.5-inch drive) screwdriver to remove the drive. 
2. Lift the drive out of the drive carrier.

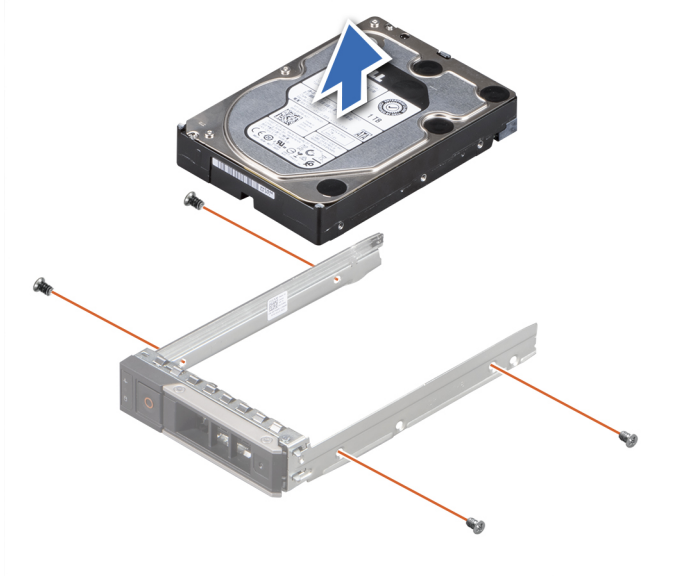

**Figure 36. Removing the drive from the drive carrier**

## Next steps

If applicable, [Install the drive into the drive carrier.](#)

# Installing a drive into the drive carrier

## Prerequisites

 **CAUTION:** Mixing drive carriers from other generations of PowerEdge servers is not supported.

## Steps

1. Insert the drive into the drive carrier with the connector end of the drive towards the back of the carrier.
2. Align the screw holes on the drive with the screw holes on the drive carrier.
3. Using a Phillips #1 screwdriver, replace the screws to secure the drive to the drive carrier.  
**i** **NOTE:** If the hard drive or SSD carrier has a Torx screw, use Torx 6 (for 2.5-inch drive) or Torx 8 (for 3.5-inch drive) screwdriver to install the drive. 

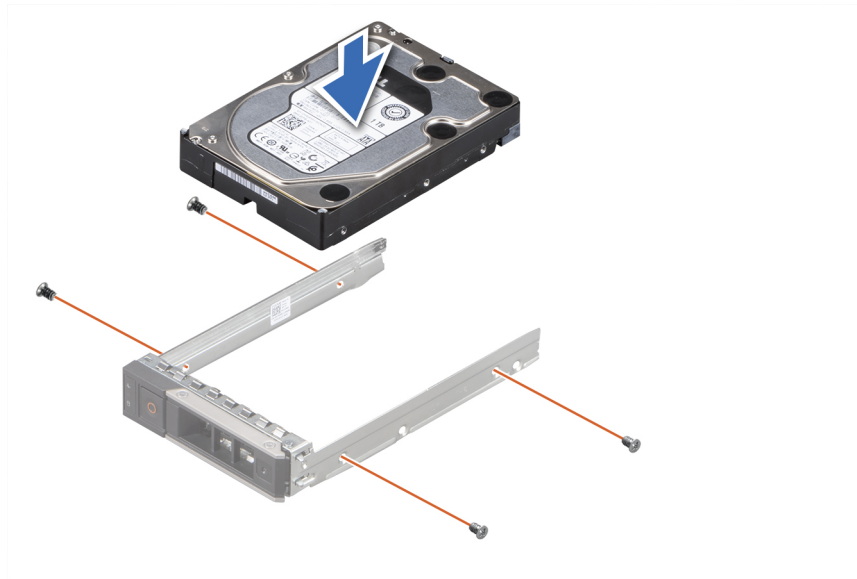

Figure 37. Installing a drive into the drive carrier

### Next steps

[Install a hard drive carrier.](#)

## Installing a drive carrier

### Prerequisites

- CAUTION:** Before attempting to remove or install a drive while the system is running, see the documentation for the storage controller card to ensure that the host adapter is configured correctly to support drive removal and insertion.
- CAUTION:** Mixing drives from previous generations of PowerEdge servers is not supported.
- CAUTION:** Combining SAS and SATA drives in the same RAID volume is not supported.
- CAUTION:** When installing a drive, ensure that the adjacent drives are installed correctly. Inserting a drive carrier and attempting to lock its handle next to an incorrectly installed carrier can damage the incorrectly installed carrier's shield spring, making it unusable.
- CAUTION:** To prevent data loss, ensure that your operating system supports hot-swap drive installation. See the documentation supplied with your operating system.
- NOTE:** When a replacement hot swappable drive is installed while the system is powered on, the drive automatically begins to rebuild. Ensure that the replacement drive is blank. Any data on the replacement drive is immediately lost once the drive is installed.

1. Follow the safety guidelines listed in [Safety instructions](#).
2. Follow the procedure listed in [Before working on your system](#).
3. If installed, [remove the hard drive blank](#).

### Steps

1. Press the release button on the front of the drive carrier to open the release handle.
2. Insert and slide the drive carrier into the drive slot.
3. Close the drive carrier release handle until it clicks in place.

**NOTE:** The numbers on the image do not depict the exact steps. The numbers are for representation of sequence.

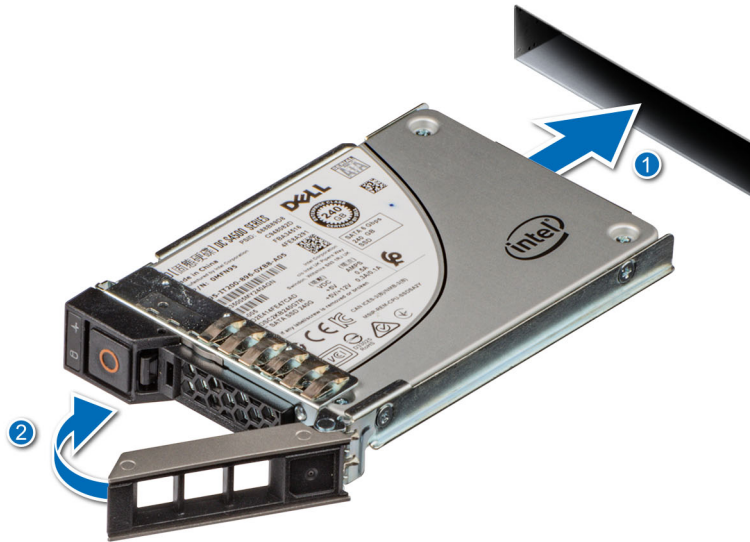

Figure 38. Installing a drive carrier

## Removing a 2.5-inch drive from a 3.5-inch drive adapter

### Prerequisites

**NOTE:** A 2.5-inch drive is installed in a 3.5-inch drive adapter, which is then installed in the 3.5-inch drive carrier.

### Steps

1. Using a Phillips #2 screwdriver, remove the screws from the side of the 3.5-inch drive adapter.

**NOTE:** If the 2.5-inch drive has a Torx screw, use Torx 6 screwdriver to remove the drive from a 3.5-inch drive adapter. 

2. Remove the 2.5-inch drive from the 3.5-inch drive adapter.

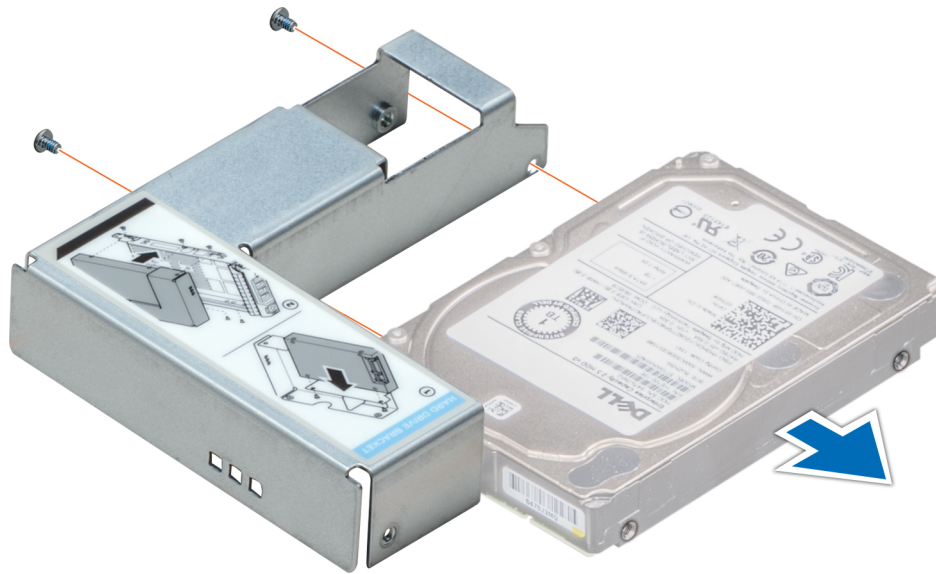

**Figure 39. Removing a 2.5 inch drive from a 3.5-inch drive adapter**

#### **Next steps**

Install 2.5 inch drive into 3.5 inch adapter.

## **Installing a 2.5-inch drive into a 3.5-inch drive adapter**

#### **Prerequisites**

1. Follow the safety guidelines listed in [Safety instructions](#).
2. Follow the procedure listed in [Before working on your system](#).

#### **Steps**

1. Align the screw holes on the 2.5-inch drive with the screw holes on the 3.5-inch drive adapter.
2. Using a Phillips #2 screwdriver, secure the 2.5-inch drive to the 3.5-inch drive adapter.

**NOTE:** If the 2.5-inch drive has a Torx screw, use Torx 6 screwdriver to install the drive to a 3.5-inch drive adapter. 

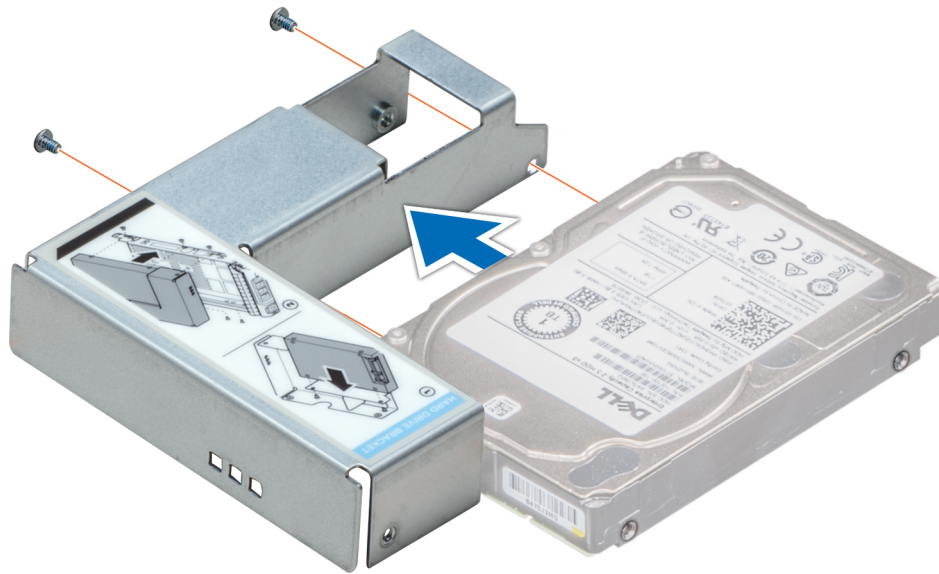

**Figure 40. Installing a 2.5-inch drive into a 3.5-inch drive adapter**

## System memory

### System memory guidelines

The PowerEdge R360 system supports DDR5 ECC unbuffered DIMMs (UDIMMs).

Your system memory is organized into two channels per processor (two memory sockets per channel), four memory sockets per system.



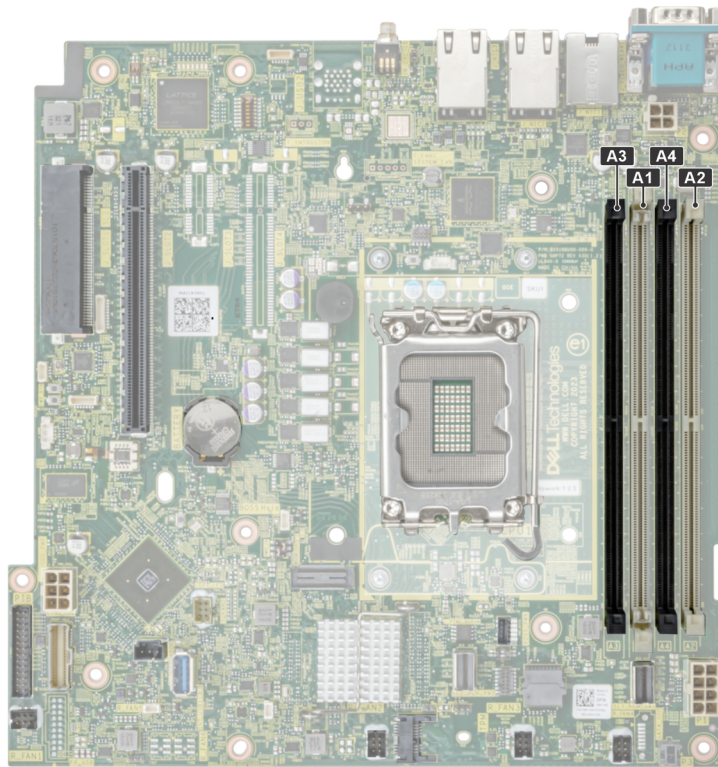

**Figure 41. Memory channels**

Memory channels are organized as follows:

**Table 61. Memory channels**

Processor	Channel A	Channel B
Processor 1	A1, A3	A2, A4

**Table 62. Supported memory matrix**

DIMM type	Rank	Capacity	DIMM rated voltage and speed	Operating Speed	
				1 DIMM per channel (DPC)	2 DIMM per channel (DPC)
ECC UDIMM	1 R	16 GB	DDR5 (1.1 V), 4800 MT/s	4400 MT/s	4000 MT/s
	2 R	32 GB	DDR5 (1.1 V), 4800 MT/s	4400 MT/s	3600 MT/s
	1 R	16 GB	DDR5 (1.1 V), 5600 MT/s	4400 MT/s	4000 MT/s
	2 R	32 GB	DDR5 (1.1 V), 5600 MT/s	4400 MT/s	3600 MT/s

**NOTE:** The processor may reduce the performance of the rated DIMM speed.



# General memory module installation guidelines

To ensure optimal performance of your system, observe the following general guidelines when configuring your system memory. If your system's memory configuration fails to observe these guidelines, your system might not boot, stop responding during memory configuration, or operate with reduced memory.

The memory bus may operate at speeds of 4800 MT/s, 4400 MT/s, 4000 MT/s, or 3600 MT/s depending on the following factors:

- System profile selected (for example, Performance, Performance Per Watt Optimized (OS), or Custom [can be run at high speed or lower])
- Maximum supported DIMM speed of the processors
- Maximum supported speed of the DIMMs

 **NOTE:** MT/s indicates DIMM speed in MegaTransfers per second.

- All DIMMs must be DDR5.
- If memory modules with different speeds are installed, they operate at the speed of the slowest installed memory module(s).
- Populate memory module sockets only if a processor is installed.
  - For single-processor systems, sockets A1 to A4 are available.
  - A minimum of one DIMM must be populated for each installed processor.
- In **Optimizer Mode**, the DRAM controllers operate independently in the 64-bit mode and provide optimized memory performance.

**Table 63. Memory population rules**

Processor	Memory population	Memory population information
Single processor	A{1}, A{2}, A{3}, A{4}	1, 2, 4 DIMMs are allowed.

- Populate all the sockets with white release tabs first.
- Unbalanced or odd memory configurations result in a performance loss, and the system may not identify the memory modules being installed. Always populate memory channels identically with equal DIMMs for the best performance.

## Removing a memory module

### Prerequisites

1. Follow the safety guidelines listed in [Safety instructions](#).
2. Follow the procedure listed in [Before working on your system](#).
3. Remove the system from the rack and place it on an ESD work bench. For more information, see the *Rail Installation Guide* at [PowerEdge manuals](#).
4. [Remove air shroud](#).

### Steps

1. Push the ejectors outward on both ends of the memory module socket to release the memory module from the socket.
2. Lift and remove the memory module from the system.

 **CAUTION:** Handle memory modules only by the card edges, ensuring not to touch the middle of the memory module or metallic contacts.

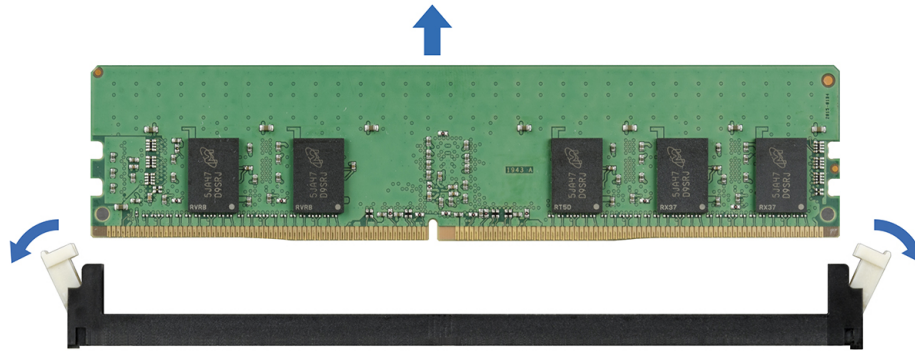

Figure 42. Removing a memory module

### Next steps

Install the memory module.

## Installing a memory module

### Prerequisites

1. Follow the safety guidelines listed in [Safety instructions](#).
2. Follow the procedure listed in [Before working on your system](#).
3. Remove the system from the rack and place it on an ESD work bench. For more information, see the *Rail Installation Guide* at [PowerEdge manuals](#).
4. [Remove air shroud](#).

Locate the appropriate memory module socket.

**NOTE:** The procedure to remove a memory module blank is similar to the procedure to remove a memory module. Retain the removed memory module blank for future use.

### Steps

1. Open the ejectors on the memory module socket outward to allow the memory module to be inserted into the socket.
2. Align the edge connector of the memory module with the alignment key of the memory module socket, and insert the memory module in the socket.

**CAUTION:** Handle each memory module only by the card edges, ensuring not to touch the middle of the memory module or metallic contacts.

**NOTE:** The memory module socket has an alignment notch that enables you to install the memory module in the socket in only one orientation.

3. Press the memory module with your thumbs until the ejectors firmly click into place.

**CAUTION:** To prevent damage to the memory module or the memory module socket during installation, do not bend or flex the memory module. You must insert both ends of the memory module simultaneously.

**CAUTION:** Do not apply pressure at the center of the memory module; apply pressure at both ends of the memory module evenly.

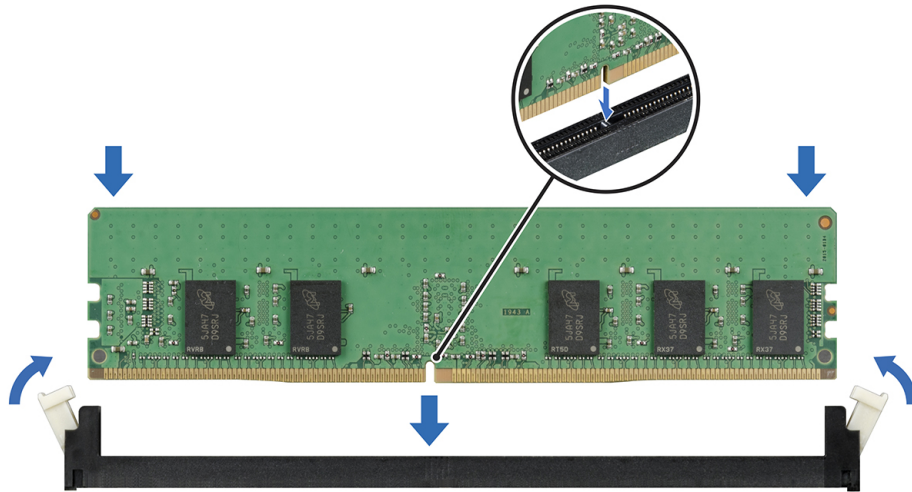

**Figure 43. Installing a memory module**

### Next steps

1. [Install the air shroud.](#)
2. Follow the procedure listed in [After working inside your system.](#)
3. To verify if the memory module has been installed properly, press F2 and navigate to **System Setup Main Menu > System BIOS > Memory Settings**. In the **Memory Settings** screen, the System Memory Size must reflect the updated capacity of the installed memory.
4. If the value is incorrect, one or more of the memory modules may not be installed properly. Ensure that the memory module is firmly seated in the memory module socket.
5. Run the system memory test in system diagnostics.

## Processor and heat sink module

This is a service technician replaceable part only.

## Removing the heat sink module

### Prerequisites

1. Follow the safety guidelines listed in the [Safety instructions.](#)
2. Follow the procedure listed in the [Before working inside your system.](#)
3. [Remove air shroud.](#)

**i** **NOTE:** The heat sink and processor are hot to touch for some time after the system has been powered off. Allow the heat sink and processor to cool down before handling them.

### Steps

1. Using a screwdriver, loosen the screws on the heat sink in the order below:
  - a. Loosen the first screw three turns.
  - b. Loosen the rest of the screws in the order numbered.
  - c. Return to the first screw and loosen it completely.
2. Lift the heat sink from the system.

**i** **NOTE:** The numbers on the image do not depict the exact steps. The numbers are for representation of sequence.

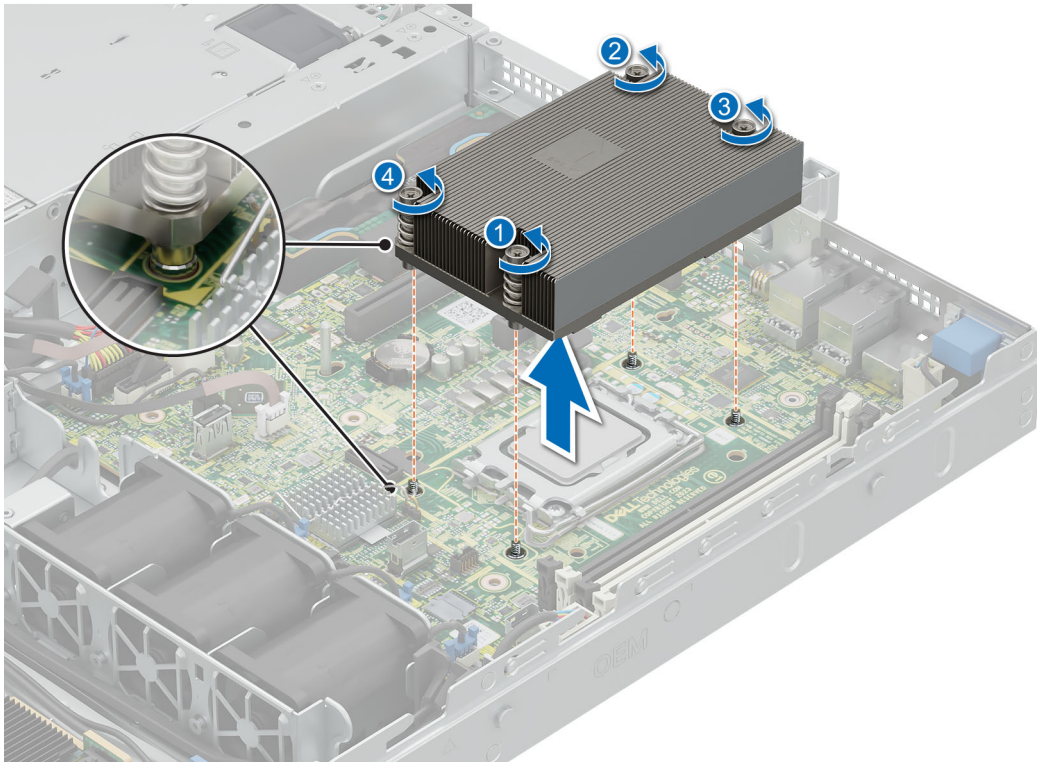

**Figure 44. Removing the heat sink module**

### Next steps

If you are removing a faulty heat sink [install the heatsink](#), if not [remove the processor](#).

## Removing the processor

### Prerequisites

**WARNING:** Remove the processor from processor and heat sink module (PHM) only if you are replacing the processor or heat sink.

1. Follow the safety guidelines listed in the [Safety instructions](#).
2. Follow the procedure listed in the [Before working inside your system](#).
3. [Remove air shroud](#).
4. [Remove the heatsink](#).

**CAUTION:** You may find the CMOS battery loss or CMOS checksum error that is displayed during the first instance of powering on the system after the processor or system board replacement which is expected. To fix this, simply go to setup option to configure the system settings.

### Steps

1. Release the socket lever by pushing the lever down and then out from under the tab on the processor shield.
2. Lift the lever upward until the processor shield lifts.

**CAUTION:** The processor socket pins are fragile and can be permanently damaged. Be careful not to bend the pins in the processor socket when removing the processor out of the socket.

3. Holding the processor by the edges, lift the processor out of the socket.

**NOTE:** The numbers on the image do not depict the exact steps. The numbers are for representation of sequence.



**Figure 45. Removing the processor**

### Next steps

Install the processor.

## Installing the processor

### Prerequisites

1. Follow the safety guidelines listed in the [Safety instructions](#).
2. Follow the procedure listed in [Before working inside your system](#).
3. [Remove air shroud](#).
4. [Remove the heatsink](#).

### Steps

1. Align the pin 1 indicator of the processor with the triangle on the socket and place the processor on the socket.

**NOTE:** Positioning the processor incorrectly can permanently damage the system board or the processor. Be careful not to bend the pins in the socket.

2. Lower the socket lever and push it under the tab to lock it.

**NOTE:** If the processor has previously been used in a system, remove any remaining thermal grease from the processor by using a lint-free cloth.

**NOTE:** The numbers on the image do not depict the exact steps. The numbers are for representation of sequence.

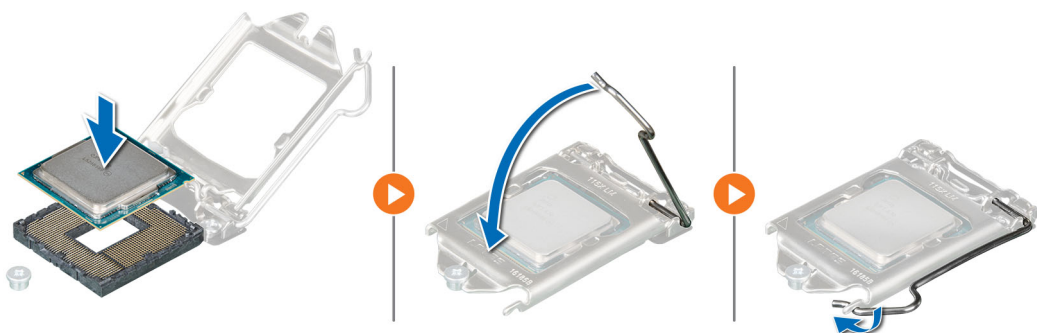

**Figure 46. Installing the retaining clip**

3. If you are using an existing heat sink, remove the thermal grease from the heat sink by using a clean lint-free cloth.
4. Apply the thermal grease in a thin spiral design on top of the processor.

**CAUTION:** Applying too much thermal grease can result in excess grease coming in contact with and contaminating the processor socket.

**NOTE:** The thermal grease syringe is intended for single use only. Dispose the syringe after you use it.



Figure 47. Applying thermal grease

**NOTE:** Ensure that you install the heat sink after you install the processor. The heat sink is necessary to maintain proper thermal conditions.

#### Next steps

1. Install the heatsink.
2. Install the air shroud.
3. Follow the procedure listed in [After working inside your system](#).

## Installing the processor and heat sink module

#### Prerequisites

Never remove the heat sink from a processor unless you intend to replace the processor or heat sink. The heat sink is necessary to maintain proper thermal conditions.

1. Follow the safety guidelines listed in the [Safety instructions](#).
2. Follow the procedure listed in [Before working inside your system](#).
3. [Remove air shroud](#).

#### Steps

1. If you are using an existing heat sink, remove the thermal grease from the heat sink by using a clean lint-free cloth.
2. Use the thermal grease syringe included with your processor kit to apply the grease in a quadrilateral design on the top of the processor.

**CAUTION:** Applying too much thermal grease can result in excess grease coming in contact with and contaminating the processor socket.

**NOTE:** The thermal grease syringe is intended for single use only. Dispose the syringe after you use it.



**Figure 48. Applying thermal grease**

3. Align the cut-off on the heat sink to the triangle system board, and then place the heat sink module on the processor socket.

**CAUTION:** To avoid damaging the fins on the heat sink, do not press down on the heat sink fins.

**NOTE:** Ensure that the heatsink is held parallel to the system board to prevent damaging the components.

4. Using a screwdriver, tighten the screws in the following order to secure the heat sink to the system board.
  - a. Tighten the first screw three turns.
  - b. Tighten the rest of the screws in the order numbered.
5. Return to the first screw to tighten it.

**NOTE:** The numbers on the image do not depict the exact steps. The numbers are for representation of sequence.



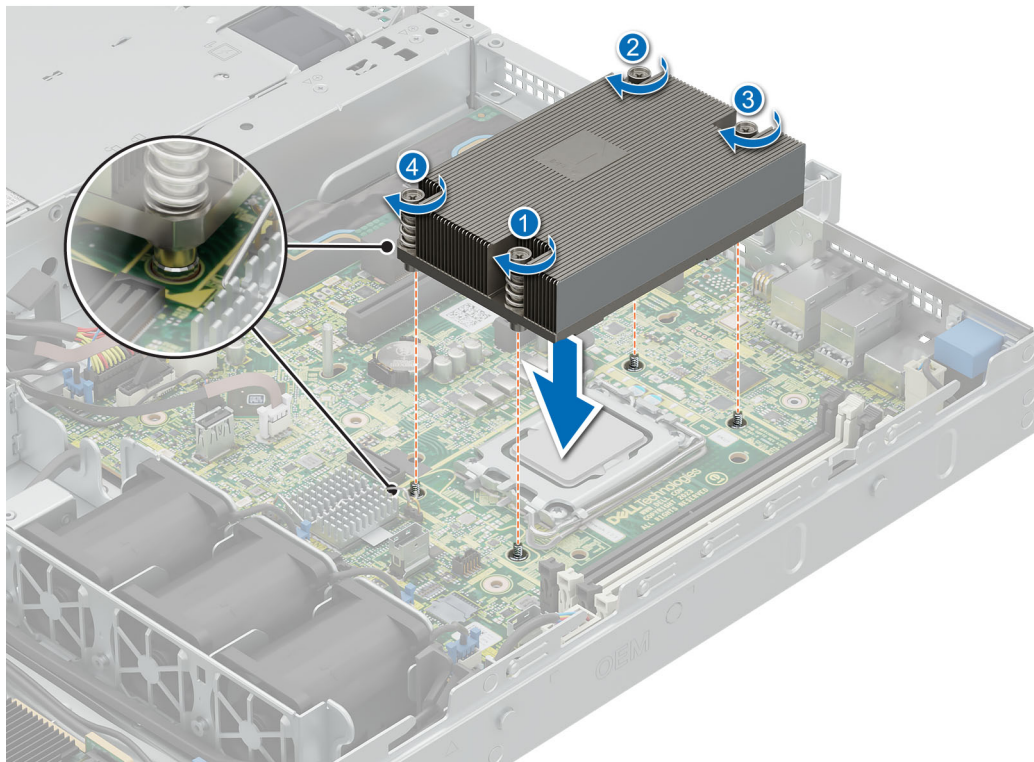

**Figure 49. Installing the heat sink**

**Next steps**

1. [Install the air shroud.](#)
2. Follow the procedure listed in [After working inside your system.](#)

## Expansion cards and expansion card risers

**NOTE:** A System Event Log (SEL) event is logged if an expansion card riser is not supported or missing. It does not prevent your system from turning on. However, if a F1/F2 pause occurs with an error message, see *Troubleshooting expansion cards* section in the *Dell PowerEdge Servers Troubleshooting Guide* at [PowerEdge manuals](#).

### Expansion card installation guidelines

The following table provides guidelines for installing expansion cards to ensure proper cooling and mechanical fit. The expansion cards with the highest priority should be installed first using the slot priority indicated. All the other expansion cards should be installed in the card priority and slot priority order.

**Table 64. Expansion card riser configurations**

Configurations	Expansion card risers	PCIe Slot number	Form factor	Controlling processor	Slot's electrical bandwidth/ physical connector
Config 0	No Riser	Integrated slot	Low Profile	Processor 1	PCIe Gen4 x4 (x8 connector)
Config 1	Butterfly Riser	1	Low Profile	Processor 1	PCIe Gen4 x8 (x8 connector)
		2	Low Profile	Processor 1	PCIe Gen4 x8 (x16 connector)



**Table 65. Riser configurations: System without riser - Configuration 0 SAS/SATA**

Card type	Slot Priority	Maximum number of cards
FOXCONN (aPERC 11)	Integrated slot	1
FOXCONN (FPERC 11)	Integrated slot	1
FOXCONN (aPERC HBA11)	Integrated slot	1
FOXCONN (FPERC HBA11)	Integrated slot	1
FOXCONN (aPERC 11)	Integrated slot	1
FOXCONN (FPERC 11)	Integrated slot	1
FOXCONN (BOSS-N1)	Integrated slot	1

**Table 66. Riser configurations: System with butterfly riser : Configuration 1**

Card type	Slot Priority	Maximum number of cards
FOXCONN (GPU)	1	1
FOXCONN (GPU)	1	1
FOXCONN (aPERC 11)	Integrated slot	1
FOXCONN (FPERC 11)	Integrated slot	1
FOXCONN (aPERC HBA11)	Integrated slot	1
FOXCONN (FPERC HBA11)	Integrated slot	1
FOXCONN (External Adapter)	2,1	2
FOXCONN (aPERC 11)	Integrated slot	1
FOXCONN (FPERC 11)	Integrated slot	1
Broadcom (NIC:1Gb)	1,2	2
Intel (NIC:10Gb)	1,2	2
Broadcom (NIC:10Gb)	1,2	2
Intel (NIC:1Gb)	1,2	2
FOXCONN (BOSS-N1)	Integrated slot	1
Broadcom (NIC:25Gb)	1,2	2
Intel (NIC:25Gb)	1,2	2

## Removing an expansion card from the riser

### Prerequisites

1. Follow the safety guidelines listed in [Safety instructions](#).
2. Follow the procedure listed in [Before working on your system](#).
3. [Remove air shroud](#).
4. [Remove the expansion card riser](#).
5. Disconnect any cables that are connected to the expansion card.

### Steps

Hold the expansion card by the edges and pull it to disengage from the connector .

 **NOTE:** The numbers on the image do not depict the exact steps. The numbers are for representation of sequence.

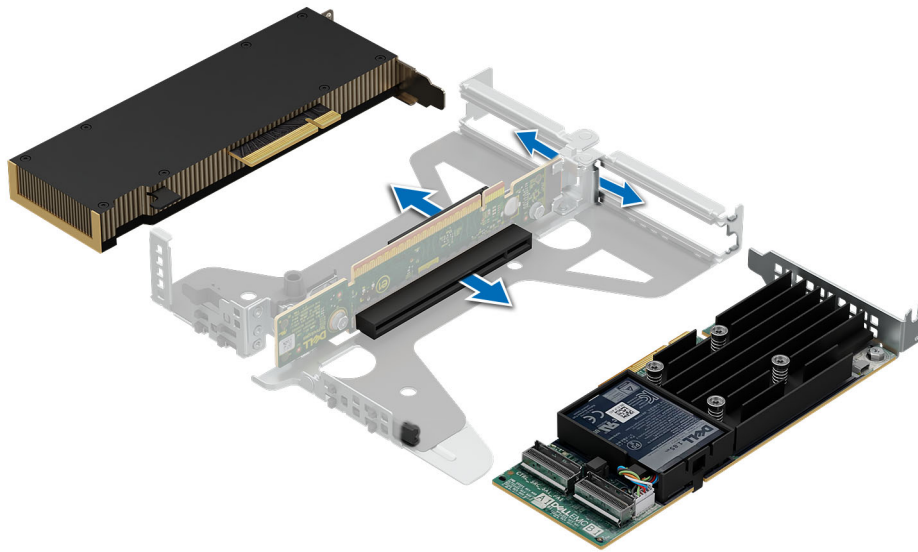

Figure 50. Removing an expansion card from the riser

### Next steps

Install the expansion card into the riser.

## Installing the expansion card in to the expansion card riser

### Prerequisites

1. Follow the safety guidelines listed in [Safety instructions](#).
2. Follow the procedure listed in [Before working on your system](#).
3. Disconnect the system from the electrical outlet, and disconnect the peripherals.
4. [Remove the expansion card riser](#).

### Steps

1. If installed, remove the filler bracket.

**i** **NOTE:** Store the filler bracket for future use. Filler brackets must be installed in empty expansion card slots to maintain Federal Communications Commission (FCC) certification of the system. The brackets also keep dust and dirt out of the system and aid in proper cooling and airflow inside the system.

**i** **NOTE:** The numbers on the image do not depict the exact steps. The numbers are for representation of sequence.

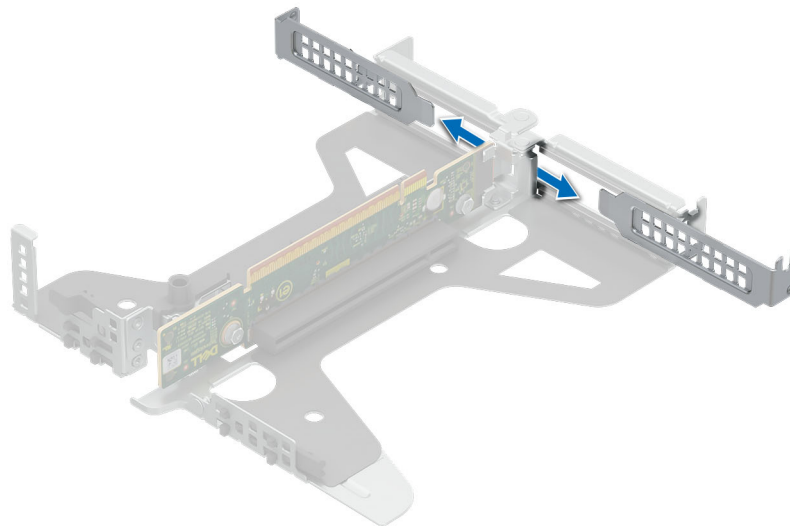

**Figure 51. Removing filler bracket from the riser**

2. To Install an expansion card into the riser.
  - a. Insert the card edge connector firmly into the expansion card connector until the card is fully seated.

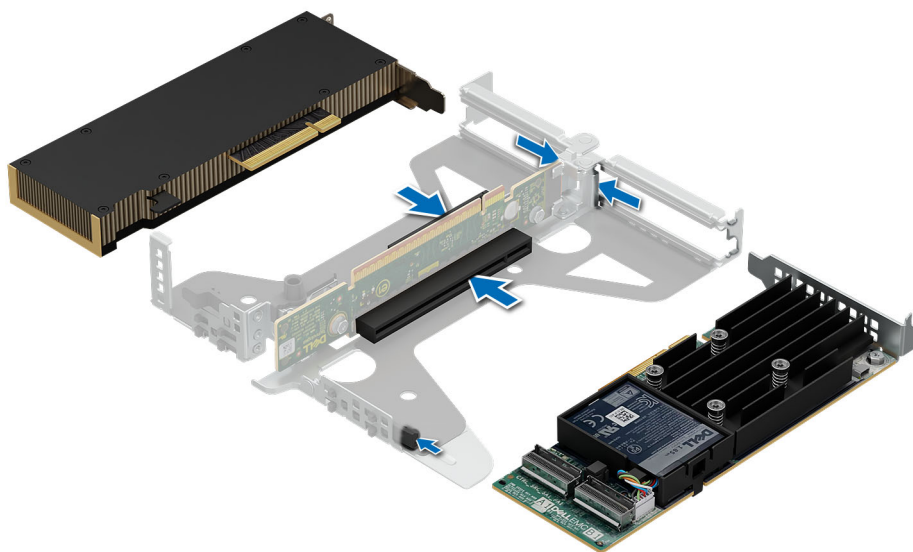

**Figure 52. Installing expansion card into the riser**

#### **Next steps**

1. [Install the expansion card riser](#)
2. If applicable, connect the cables to the expansion card.
3. [Install the air shroud.](#)
4. Follow the procedure listed in [After working inside your system.](#)

## Removing an expansion card riser

### Prerequisites

1. Follow the safety guidelines listed in [Safety instructions](#).
2. Follow the procedure listed in [Before working on your system](#).
3. [Remove air shroud](#).
4. Disconnect any cables that are connected to the expansion card.

### Steps

Hold the butterfly riser by the blue touch points and lift it from the system.

**NOTE:** The numbers on the image do not depict the exact steps. The numbers are for representation of sequence.

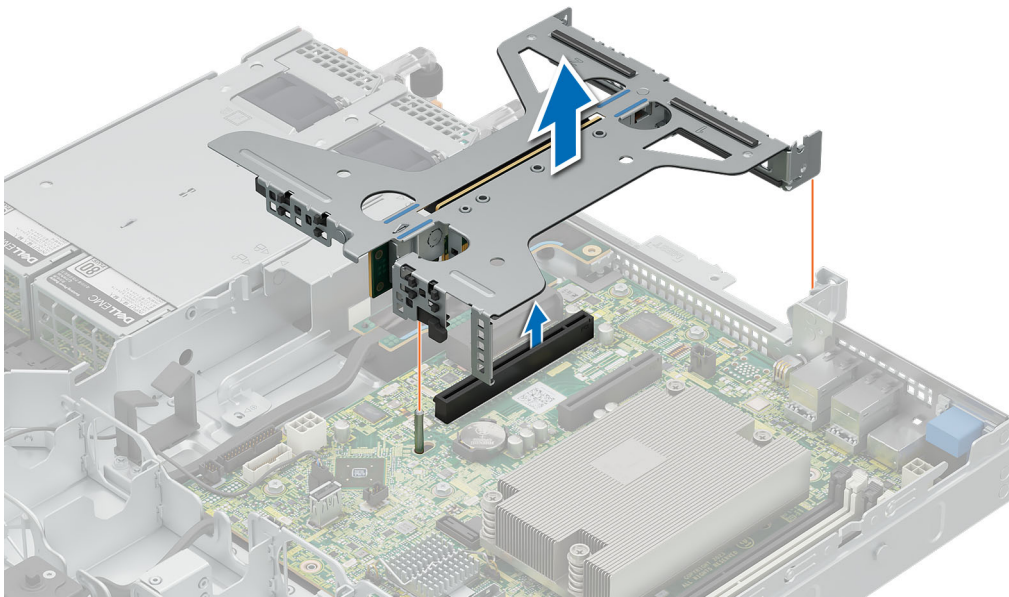

Figure 53. Removing the riser

### Next steps

Install the expansion card riser.

## Installing an expansion card riser

### Prerequisites

1. Follow the safety guidelines listed in [Safety instructions](#).
2. Follow the procedure listed in [Before working on your system](#).
3. [Remove air shroud](#).

### Steps

1. Hold the riser by the blue touch points and align it to the connector and the guide pin on the system.
2. Lower the riser into place till its firmly seated on the connector.

**NOTE:** The numbers on the image do not depict the exact steps. The numbers are for representation of sequence.

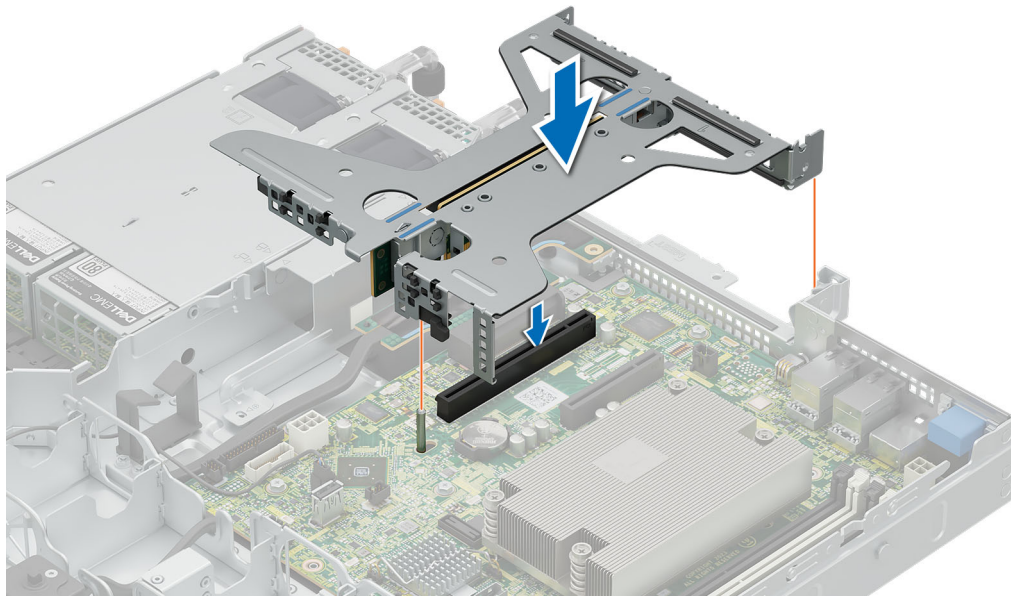

**Figure 54. Installing the riser**

#### Next steps

1. [Install the air shroud.](#)
2. Follow the procedure listed in [After working inside your system.](#)

## Optional BOSS-N1 module

### Removing the BOSS N1 module

#### Prerequisites

1. Follow the safety guidelines listed in [Safety instructions.](#)
2. Follow the procedure listed in [Before working on your system.](#)
3. [Remove air shroud.](#)

#### Steps

1. Disconnect the cables from the BOSS N1 module.
2. Lift the retention latch to unlock the BOSS N1 M.2 module.
3. Pull the BOSS N1 M.2 module out from the rear of the system.

**NOTE:** The numbers on the image do not depict the exact steps. The numbers are for representation of sequence.

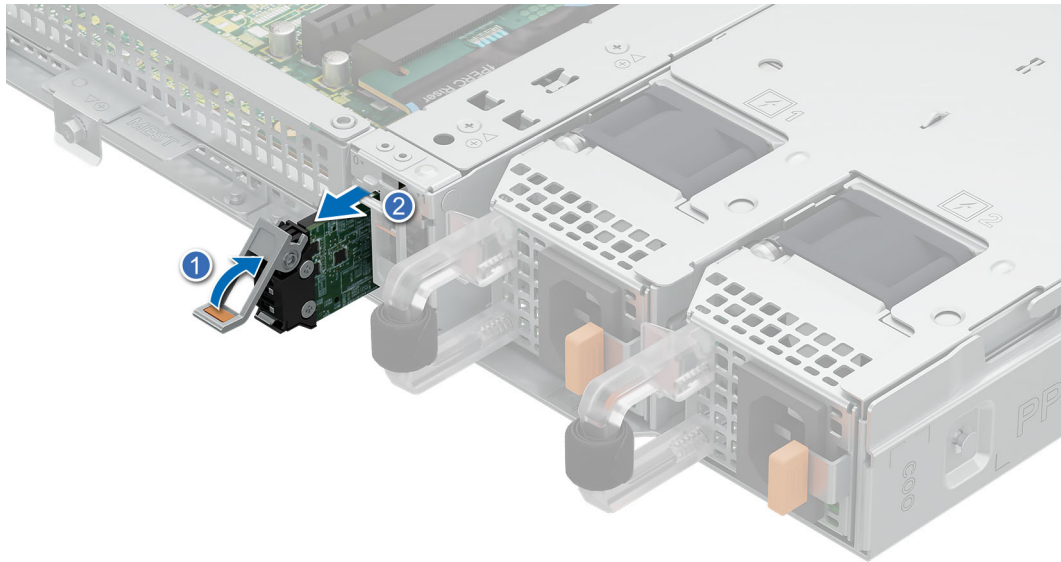

**Figure 55. Removing the BOSS N1 M.2 module**

4. Loosen and remove the single screw securing the BOSS N1 cage to the chassis floor.
5. Slide the BOSS N1 cage to the unlock position and lift from the system to remove.

**NOTE:** The numbers on the image do not depict the exact steps. The numbers are for representation of sequence.

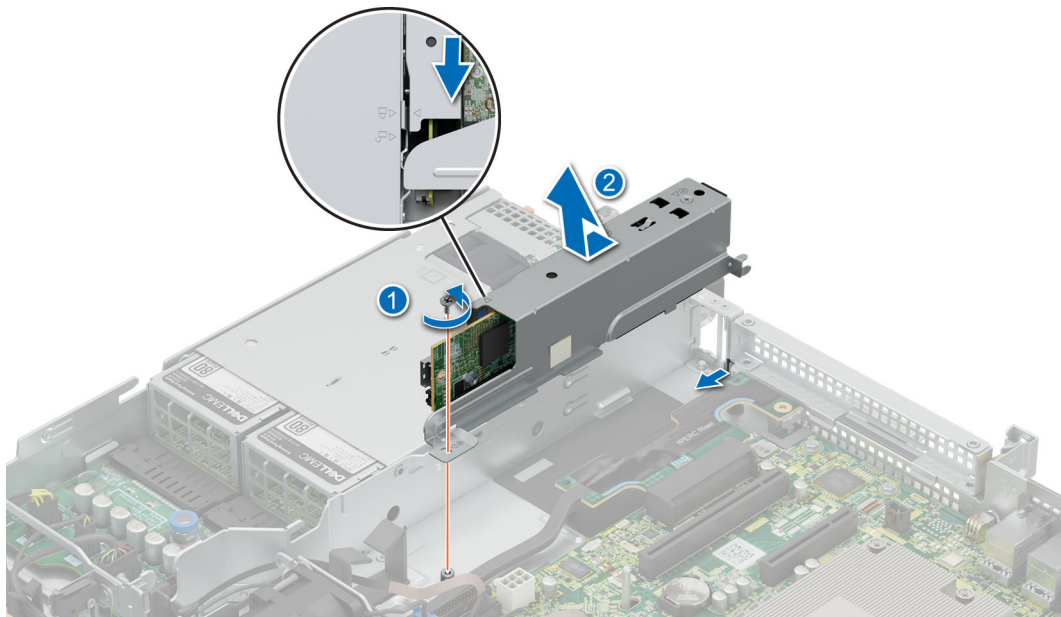

**Figure 56. Removing the BOSS N1 cage**

6. Loosen and remove the two screws securing the BOSS N1 card to the cage.
7. Pull the BOSS N1 card out from the cage.

**NOTE:** The numbers on the image do not depict the exact steps. The numbers are for representation of sequence.

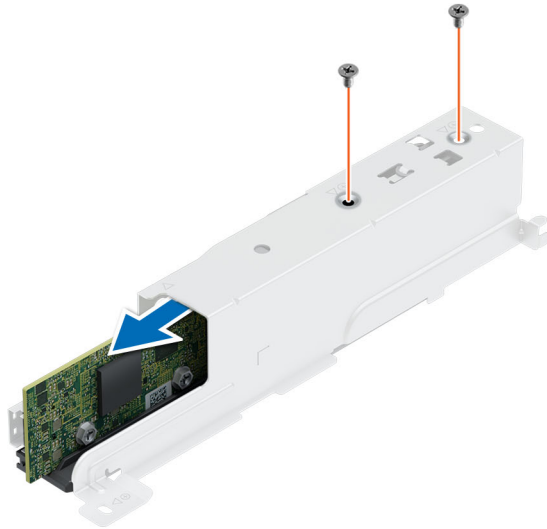

**Figure 57. Removing the BOSS N1 card**

#### **Next steps**

1. [Install the BOSS N1 module](#) or [Install the BOSS N1 blank](#).

## **Installing the BOSS N1 module**

#### **Prerequisites**

1. Follow the safety guidelines listed in the [Safety instructions](#).
2. Follow the procedure listed in [Before working inside your system](#).
3. [Remove system cover](#).
4. [Remove air shroud](#).
5. [Remove the BOSS N1 blank](#).

#### **Steps**

1. Insert the BOSS N1 card in to the cage.
2. Tighten the two screws to secure the BOSS N1 card to the cage.





**Figure 58. Installing the BOSS N1 card**

3. Ailing the BOSS N1 cage with the unlock sign and slide back into the bay till it locks firmly in place.
4. Tighten the screw to secure the BOSS N1 cage to the chassis.
5. Connect the cables to the BOSS N1 module.

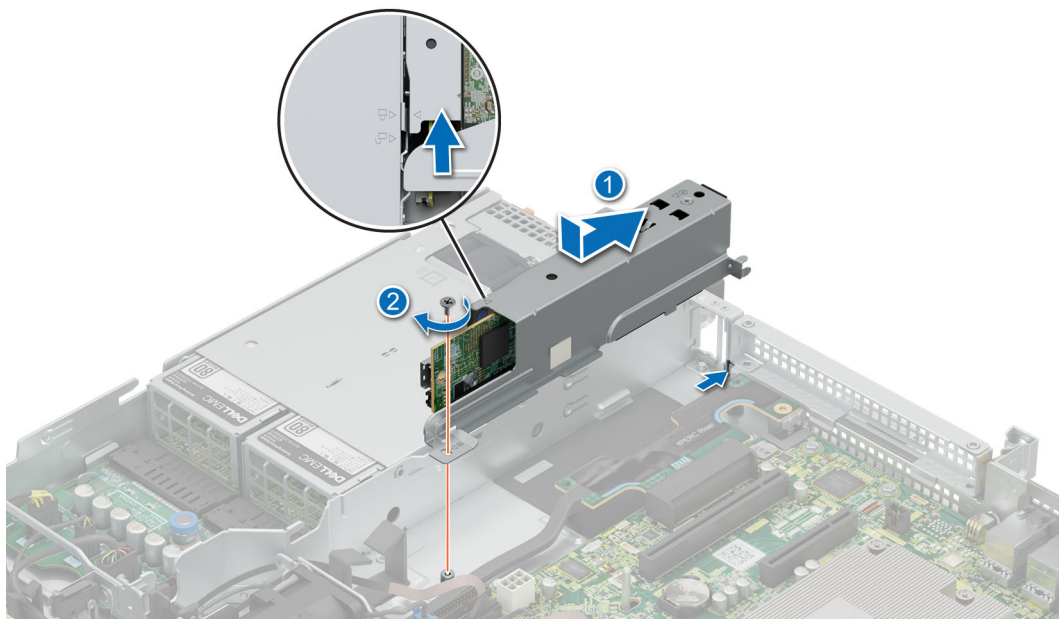

**Figure 59. Installing the BOSS N1 cage**

6. Slide the BOSS N1 M.2 carrier in to the slot.
7. Close the latch to secure the BOSS N1 M.2 carrier .



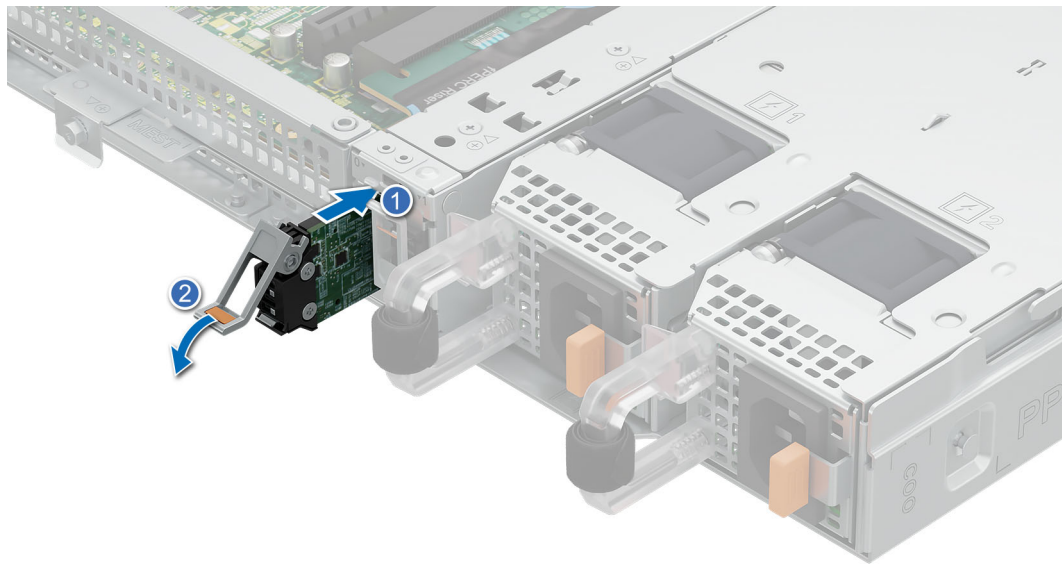

**Figure 60. Installing the BOSS N1 M.2 module**

#### **Next steps**

1. [Install the air shroud.](#)
2. [Install the system cover.](#)
3. Follow the procedure listed in [After working inside your system.](#)

## **Removing the BOSS N1 blank**

#### **Prerequisites**

1. Follow the safety guidelines listed in [Safety instructions.](#)
2. Follow the procedure listed in [Before working on your system.](#)
3. [Remove system cover.](#)
4. [Remove air shroud.](#)

#### **Steps**

Pull the N1 BOSS blank out of the system to remove it.

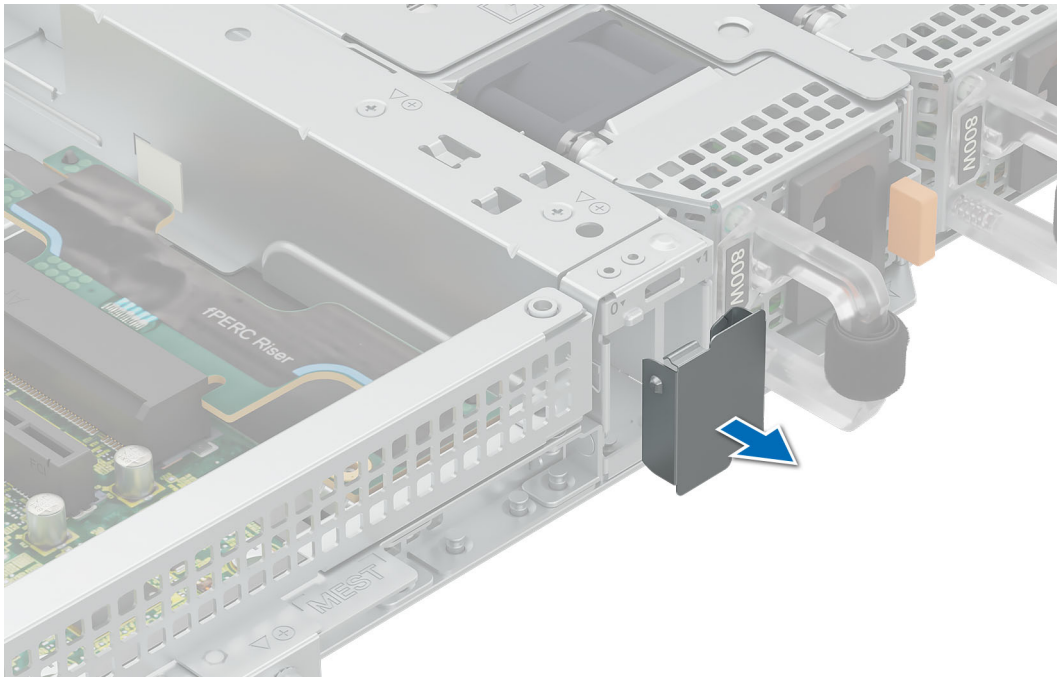

**Figure 61. Removing the BOSS N1 blank**

**Next steps**

1. [Install the BOSS N1 blank](#) or [Install the BOSS N1 module](#).

## Installing the BOSS N1 blank

**Prerequisites**

1. Follow the safety guidelines listed in [Safety instructions](#).
2. Follow the procedure listed in [Before working on your system](#).

**Steps**

Insert the BOSS N1 blank in to the system till it clicks in place.

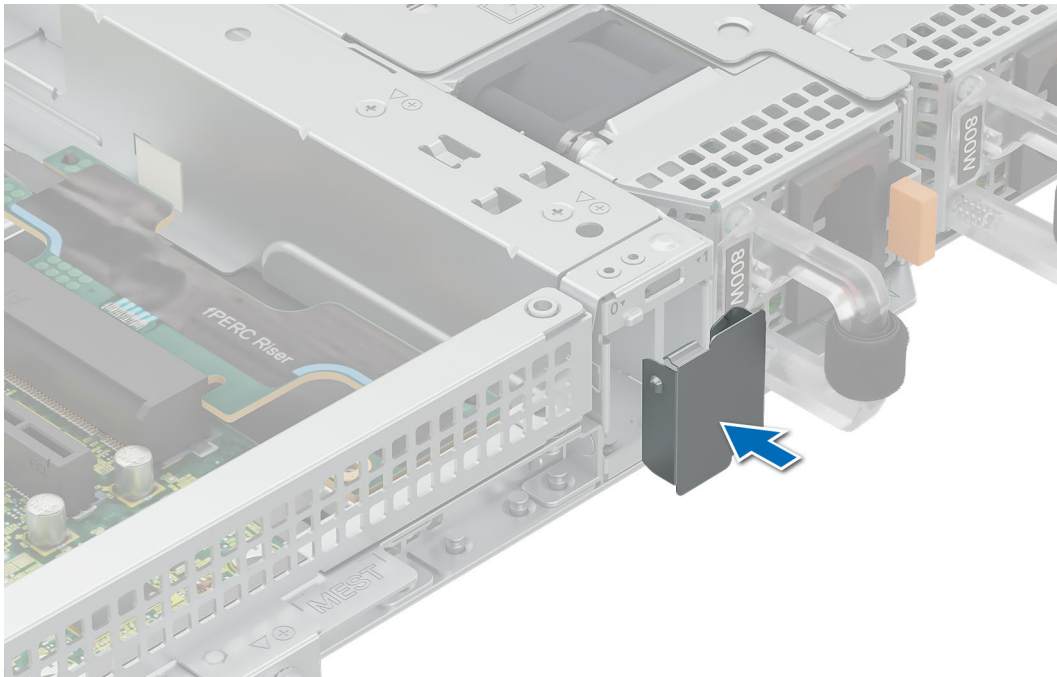

Figure 62. Installing the BOSS N1 blank

#### Next steps

1. Follow the procedure listed in [After working inside your system](#).

## System battery

This is a service technician replaceable part only.

## Replacing the system battery

#### Prerequisites

**⚠ WARNING:** There is a danger of a new battery exploding if it is incorrectly installed. Replace the battery only with the same or equivalent type that is recommended by the manufacturer. For more information, see the safety information that shipped with your system.

1. Follow the safety guidelines listed in [Safety instructions](#).
2. Follow the procedure listed in [Before working on your system](#).
3. [Remove air shroud](#).
4. [Remove expansion card riser](#)(if installed).

#### Steps

1. Press and hold the battery socket retention latch, for the battery to pop out. .

**⚠ CAUTION:** To avoid damage to the battery connector, you must firmly support the connector while installing or removing a battery.

**i NOTE:** If the battery does not pop out, then lift it out of the socket.

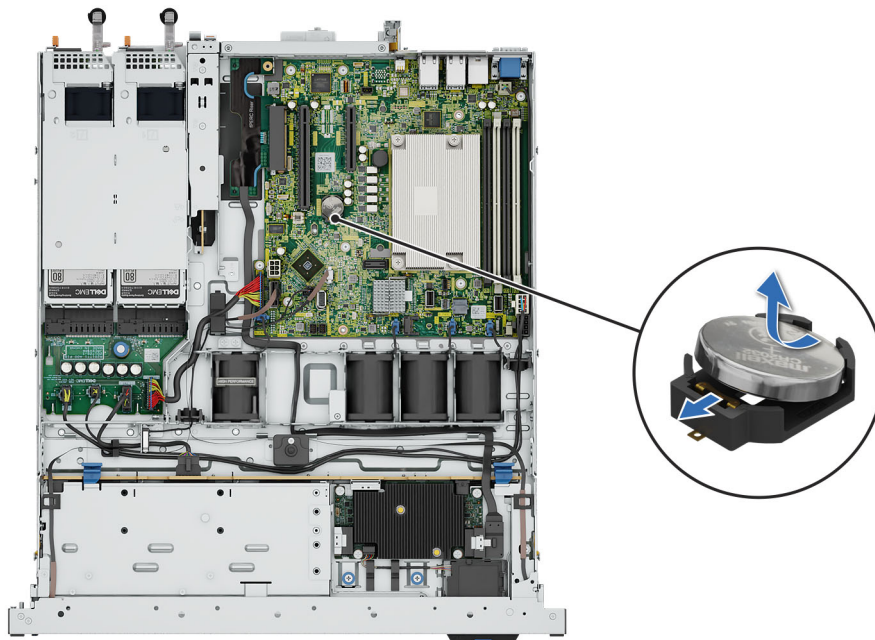

**Figure 63. Removing the system battery**

2. To install a new system battery, hold the battery with the positive side facing up and slide it under the socket battery latch.
3. Press the battery into the connector until it snaps into place.

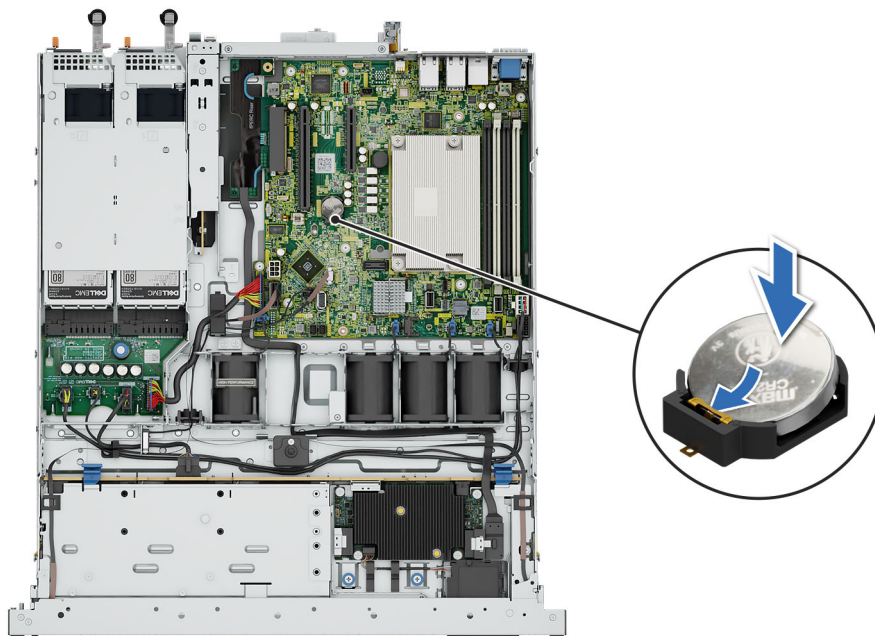

**Figure 64. Installing the system battery**

#### **Next steps**

1. [Install the expansion card riser](#) (if removed).
2. [Install the air shroud](#).
3. Follow the procedure listed in [After working inside your system](#).

# PERC card

Your system includes dedicated slots on the system board for PERC cards.

## Removing the internal PERC card

### Prerequisites

1. Follow the safety guidelines listed in [Safety instructions](#).
2. Follow the procedure listed in [Before working on your system](#).
3. [Remove air shroud](#).
4. [Remove the expansion card riser](#) (if installed).

### Steps

1. Loosen and remove the two screws securing the PERC card.
2. Hold the metal holder, slide the PERC card towards the PSU to remove it from the system.

 **NOTE:** The numbers on the image do not depict the exact steps. The numbers are for representation of sequence.

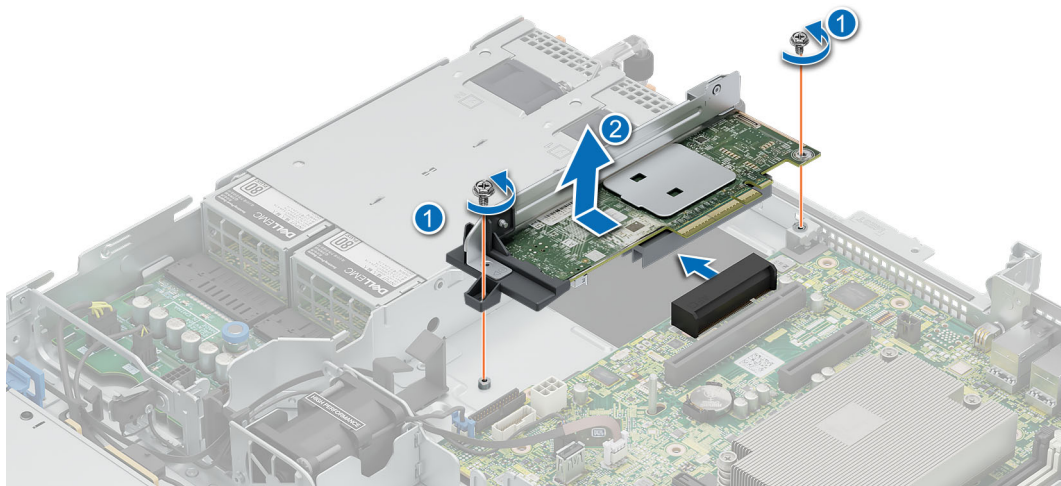

**Figure 65. Removing the internal PERC card**

### Next steps

1. [Install the adapter PERC](#).

## Installing the internal PERC card

### Prerequisites

1. Follow the safety guidelines listed in [Safety instructions](#).
2. Follow the procedure listed in [Before working on your system](#).
3. [Remove air shroud](#).
4. [Remove the expansion card riser](#) (if installed).



### Steps

1. Hold the PERC card by the metal holder and align the connector to the slot on the system board.
2. Slide the PERC card into the slot till its firmly seated.
3. Install and tighten the two screws to secure the PERC card.

 **NOTE:** The numbers on the image do not depict the exact steps. The numbers are for representation of sequence.

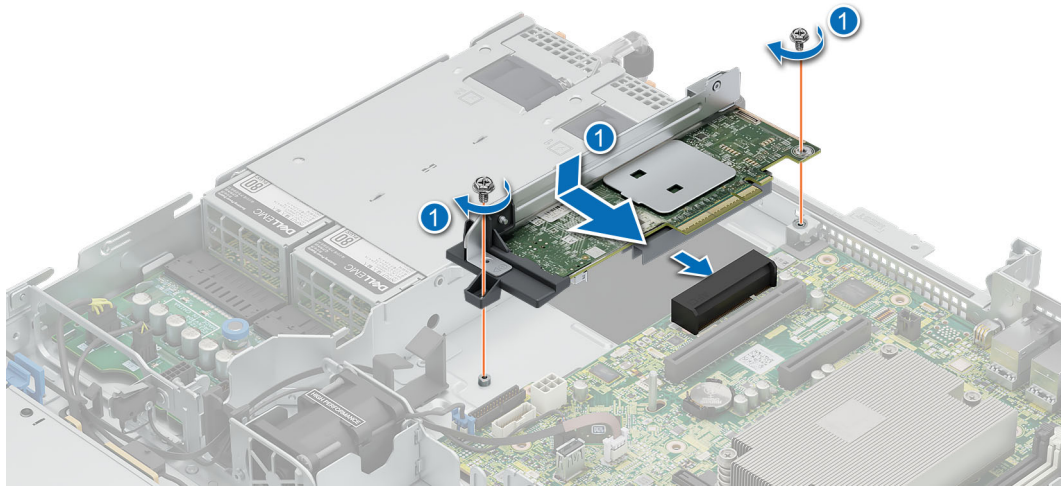

**Figure 66. Installing the internal PERC card**

### Next steps

1. [Install the expansion card riser](#)(if removed).
2. [Install the air shroud](#).
3. Follow the procedure listed in [After working inside your system](#).

## Removing the front mounting front PERC riser and front PERC module

### Prerequisites

1. Follow the safety guidelines listed in [Safety instructions](#).
2. Follow the procedure listed in [Before working on your system](#).
3. [Remove air shroud](#).
4. [Remove the expansion card riser](#) (if installed).

### Steps

1. Loosen the two thumbscrews on the front PRERC module.
2. Pull the PERC module towards the front to the system to disconnect it from the drive backplane and lift from the system.

 **NOTE:** The numbers on the image do not depict the exact steps. The numbers are for representation of sequence.

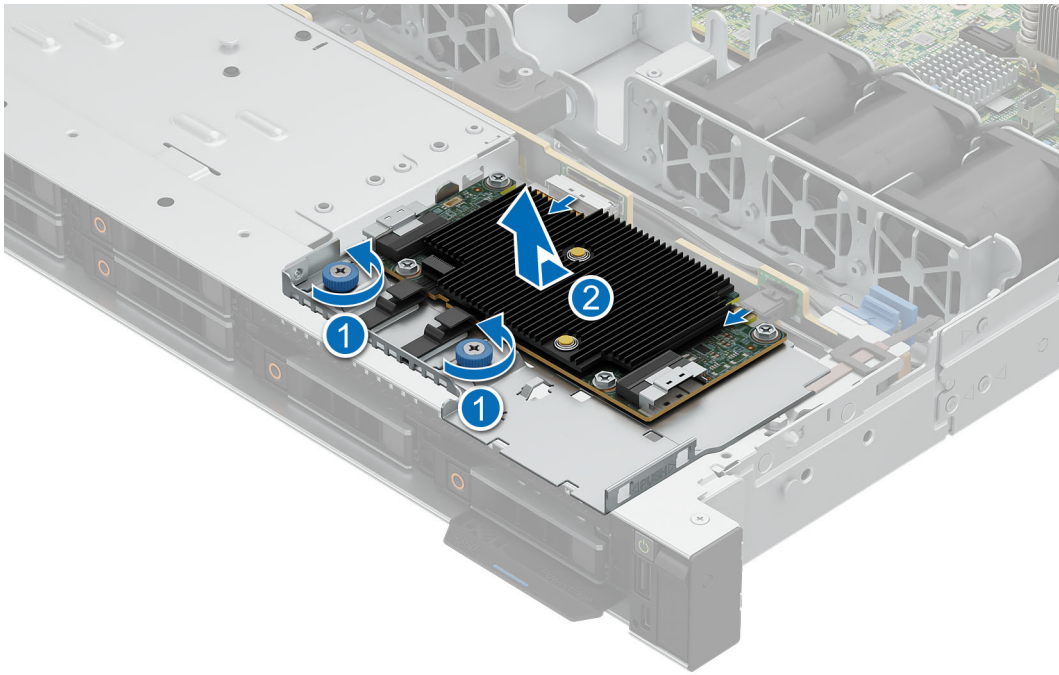

**Figure 67. Removing the front PERC card**

3. Press the release clip and remove the cable from the PERC module.

**i** **NOTE:** Observe the routing of the cable as you remove it from the system. Route the cable properly when you replace it to prevent the cable from being pinched or crimped.

4. Loosen and remove the screw securing the front PERC riser.
5. Slide the front PERC riser towards the PSU and lift from the system..

**i** **NOTE:** The numbers on the image do not depict the exact steps. The numbers are for representation of sequence.

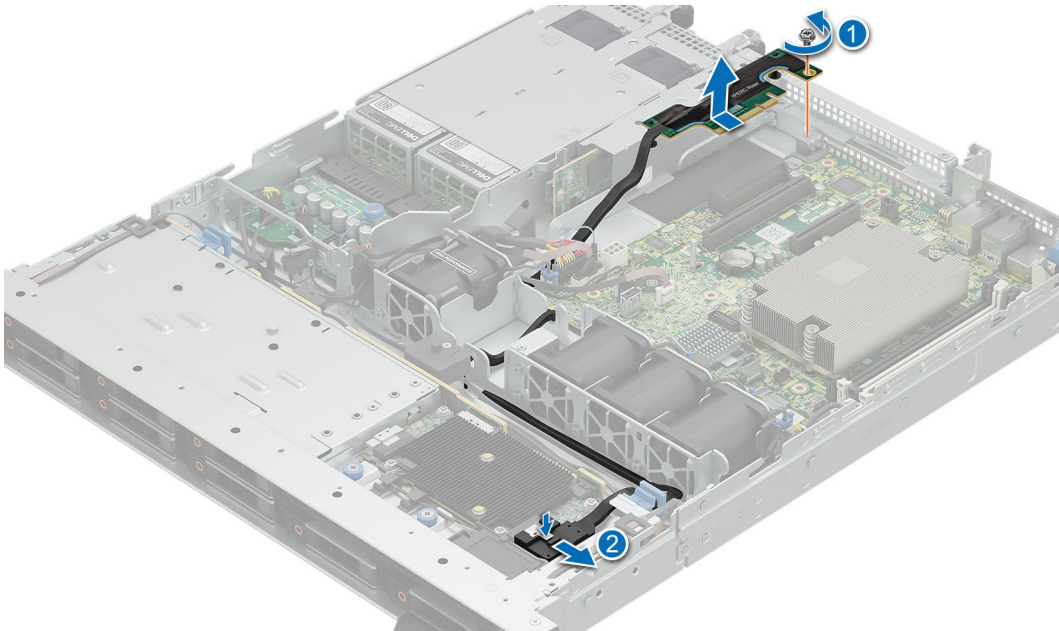

**Figure 68. Removing the front PERC card riser**

### Next steps

1. Install the front PERC module and riser.

## Installing the front mounting front PERC riser and front PERC module

### Prerequisites

1. Follow the safety guidelines listed in [Safety instructions](#).
2. Follow the procedure listed in [Before working on your system](#).
3. [Remove air shroud](#).
4. [Remove the expansion card riser](#) (if installed).

### Steps

1. Align the front PERC module at an angle until the tray touches the slot in the system.
2. Press the front PERC module connector with the connector on the drive backplane until firmly seated. Press the front PERC module connector with the connector on the drive backplane until firmly seated.
3. Tighten the thumbscrews on the front PERC module.

**NOTE:** The numbers on the image do not depict the exact steps. The numbers are for representation of sequence.

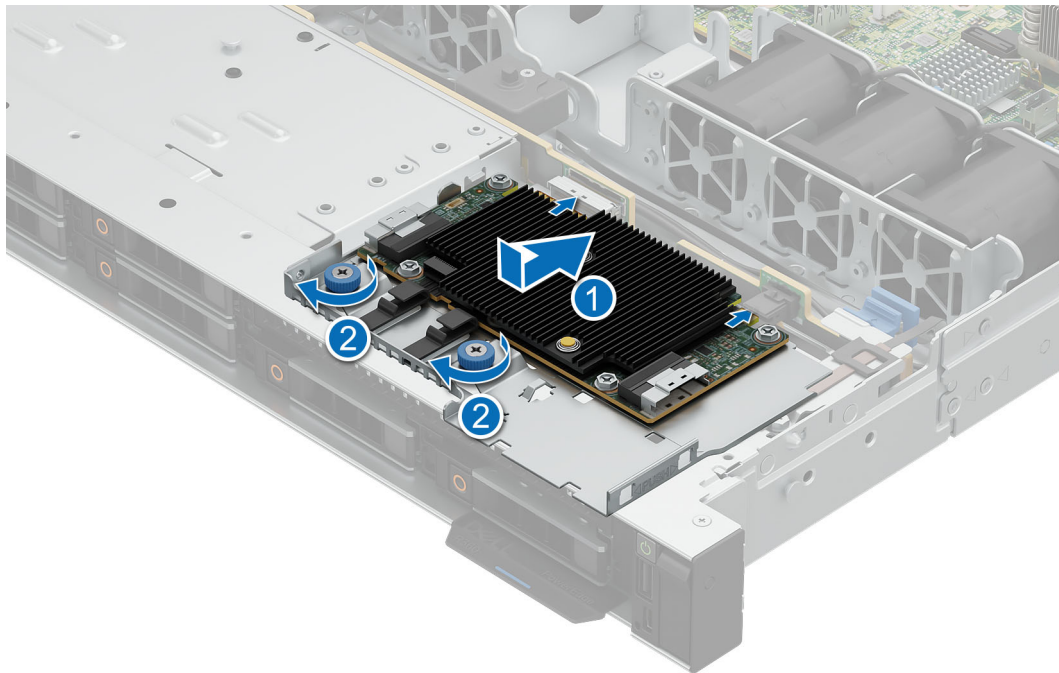

**Figure 69. Installing the front PERC module**

4. Insert the front PERC riser into the slot till firmly seated.
5. Install and tighten the screw to secure the riser.
6. Connect the cable to the front PERC module.

**NOTE:** Route the cable properly when you replace it to prevent the cable from being pinched or crimped.

**NOTE:** The numbers on the image do not depict the exact steps. The numbers are for representation of sequence.



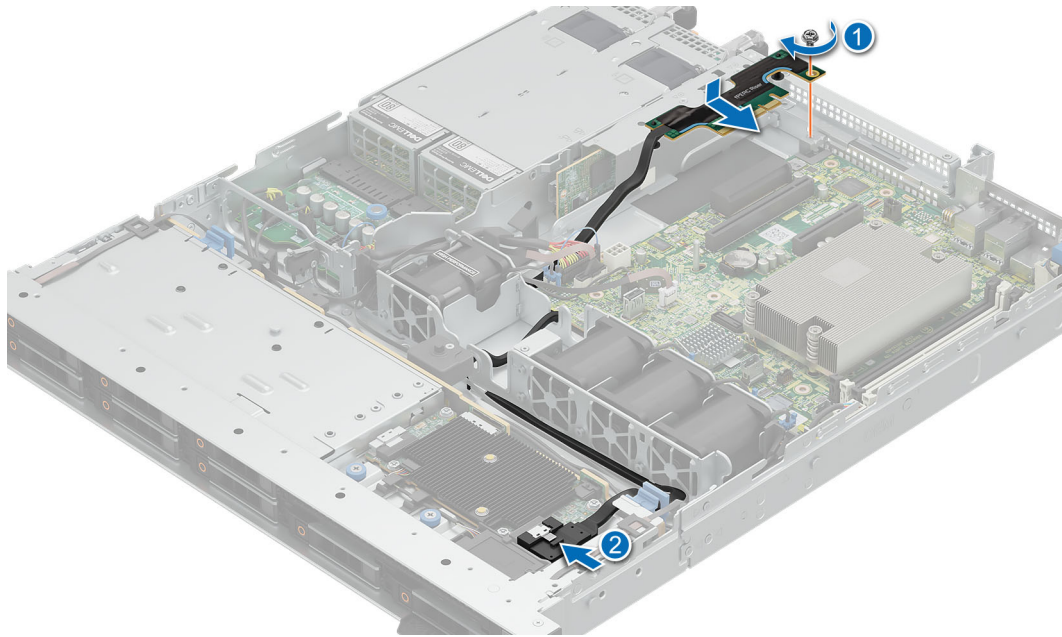

**Figure 70. Installing the front PERC riser**

#### Next steps

1. [Install the expansion card riser](#) (if removed).
2. [Install the air shroud](#).
3. Follow the procedure listed in [After working inside your system](#).

## Power supply units

### Hot spare feature

Your system supports the hot spare feature that significantly reduces the power overhead associated with power supply unit (PSU) redundancy.

When the hot spare feature is enabled, one of the redundant PSUs is switched to the sleep state. The active PSU supports 100 percent of the load, thus operating at higher efficiency. The PSU in the sleep state monitors output voltage of the active PSU. If the output voltage of the active PSU drops, the PSU in the sleep state returns to an active output state.

If having both PSUs active is more efficient than having one PSU in the sleep state, the active PSU can also activate the sleeping PSU.

The default PSU settings are as follows:

- If the load on the active PSU is more than 50 percent, then the redundant PSU is switched to the active state.
- If the load on the active PSU falls below 20 percent, then the redundant PSU is switched to the sleep state.

You can configure the hot spare feature by using the iDRAC settings. For more information about iDRAC settings, see the *Integrated Dell Remote Access Controller User's Guide* available at [iDRAC Manuals](#).

## Removing a power supply unit blank

#### Prerequisites

1. Follow the safety guidelines listed in [Safety instructions](#).
2. Follow the procedure listed in [Before working on your system](#).

## Steps

If you are installing a second power supply unit, remove the power supply unit blank in the bay by pulling the blank outward.

**CAUTION:** Proper system cooling, the power supply unit blank must be installed in the second power supply unit bay in a non-redundant configuration. Remove the power supply unit blank only if you are installing a second power supply unit.

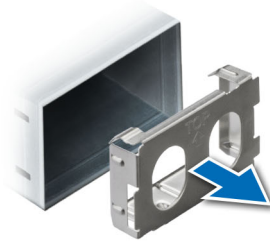

Figure 71. Removing a power supply unit blank

## Next steps

1. Install a power supply blank.
2. Follow the procedure listed in [After working inside your system](#).

# Installing a power supply unit blank

## Prerequisites

1. Follow the safety guidelines listed in [Safety instructions](#).
2. Follow the procedure listed in [Before working on your system](#).

## Steps

Align the PSU blank with the PSU bay and push it into the PSU bay until it clicks into place.

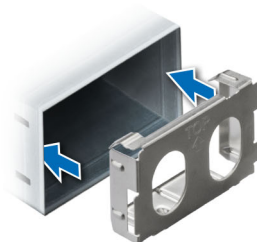

Figure 72. Installing a power supply unit blank

## Next steps

1. Follow the procedure listed in [After working inside your system](#).

## Removing a power supply unit

### Prerequisites

**CAUTION:** The system needs one power supply unit (PSU) for normal operation. On power-redundant systems, remove and replace only one PSU at a time in a system that is powered on.

1. Follow the safety guidelines listed in [Safety instructions](#).
2. Follow the procedure listed in [Before working on your system](#).
3. Disconnect the power cable from the power outlet and from the PSU that you intend to remove.
4. Remove the cable from the strap on the PSU handle.
5. Unlatch and lift or remove the optional cable management accessory if it interferes with the PSU removal.

**NOTE:** For information about the cable management when the PSU is removed or installed while the system is in a rack, see the system's cable management arm documentation at [PowerEdge Manuals](#).

### Steps

Press the orange release latch and slide the PSU out of the system by using the PSU handle.

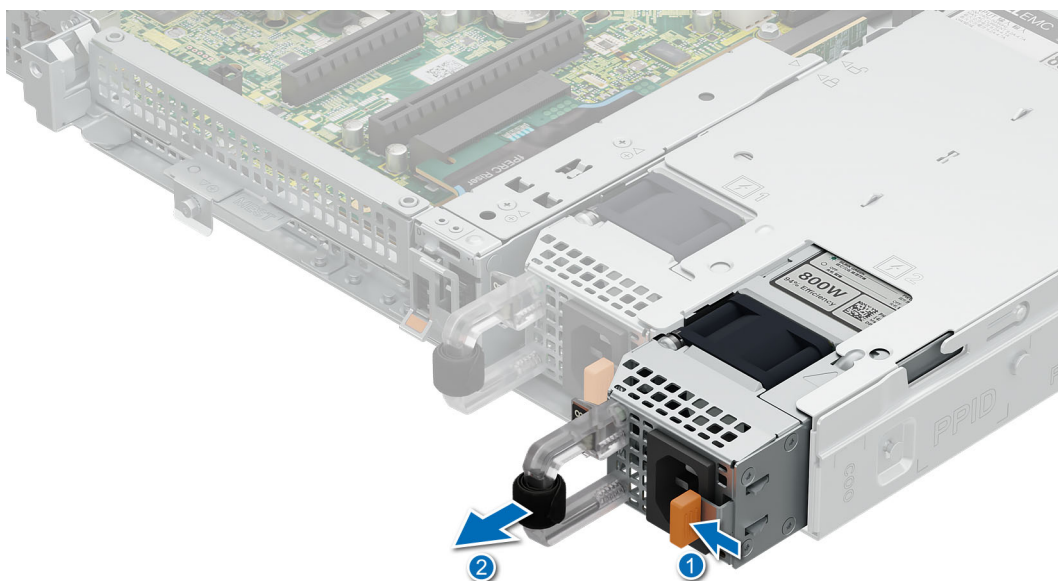

Figure 73. Removing a power supply unit

### Next steps

1. [Install the power supply unit](#) or [Install the PSU blank](#).
2. Follow the procedure listed in [After working inside your system](#).

## Installing a power supply unit

The procedure for installing AC and DC PSUs is identical.

### Prerequisites

1. Ensure that both the PSUs are of the same type and have the same maximum output power.

**NOTE:** The maximum output power (shown in watts) is listed on the PSU label.

2. Follow the safety guidelines listed in [Safety instructions](#).

3. Follow the procedure listed in [Before working on your system](#).

### Steps

Slide the PSU into the PSU bay until the PSU is fully seated and the orange release latch snaps into place.

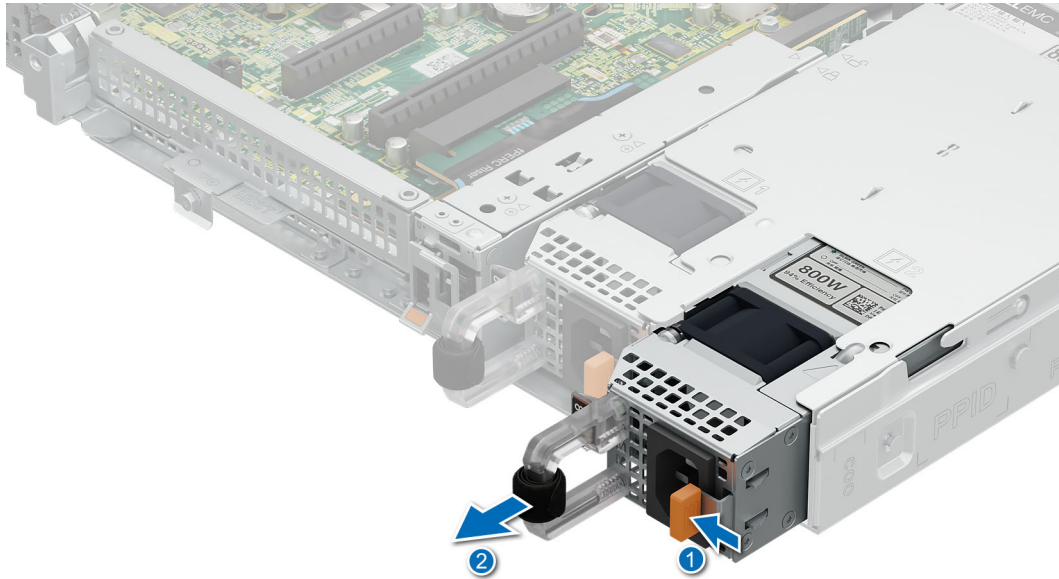

**Figure 74. Installing a power supply unit**

### Next steps

1. If you have unlatched or removed the cable management accessory, reinstall or relatch it. For information about the cable management when the PSU is removed or installed while the system is in the rack, see the system's cable management accessory documentation at [PowerEdge manuals](#).
2. Connect the power cable to the PSU, and plug the cable into a power outlet.

**CAUTION:** When connecting the power cable to the PSU, secure the cable to the PSU with the strap provided on the handle.

**NOTE:** When installing, hot swapping, or hot adding a new PSU, wait for 15 seconds for the system to recognize the PSU and determine its status. The PSU redundancy may not occur until discovery is complete. Wait until the new PSU is discovered and enabled before you remove the other PSU. The PSU status indicator turns green to signify that the PSU is functioning properly.

3. Follow the procedure listed in [After working inside your system](#).

## Power interposer board (PIB)

### Removing the PIB

#### Prerequisites

1. Follow the safety guidelines listed in [Safety instructions](#).
2. Follow the procedure listed in [Before working on your system](#).
3. [Remove air shroud](#).
4. [Remove the power supply unit](#).

## Steps

1. Pull up on the plunger to disengage the PIB from the chassis floor.
2. Slide the PIB back and lift from the system .

**NOTE:** The numbers on the image do not depict the exact steps. The numbers are for representation of sequence.

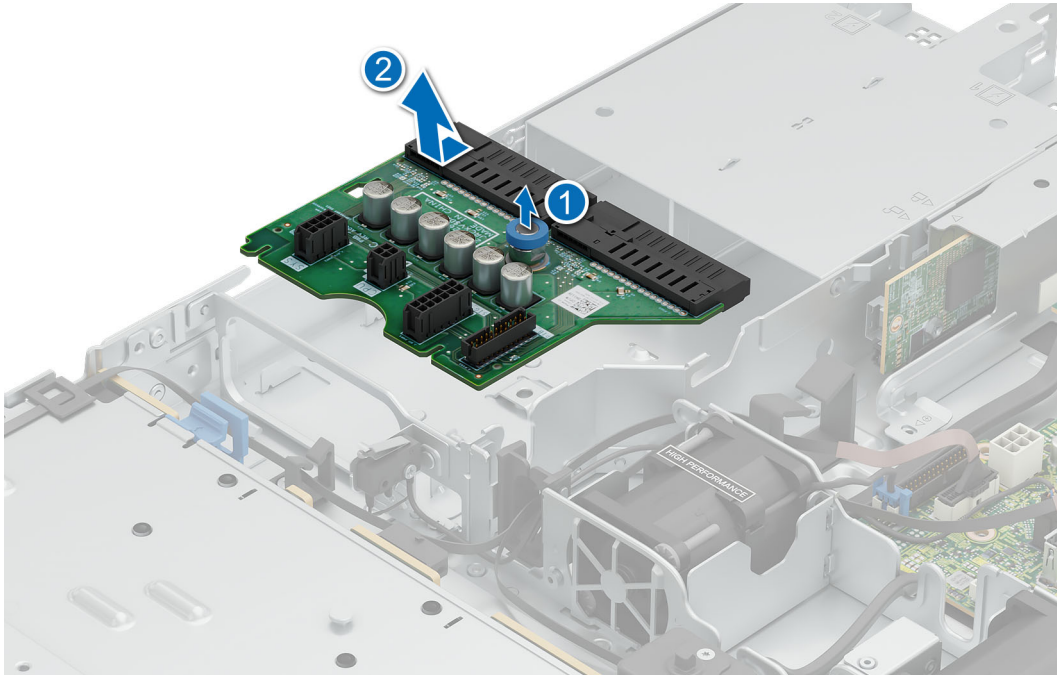

**Figure 75. Removing the PIB**

## Next steps

Install the PIB.

# Installing the PIB

## Prerequisites

1. Follow the safety guidelines listed in [Safety instructions](#).
2. Follow the procedure listed in [Before working on your system](#).
3. [Remove air shroud](#).
4. [Remove the power supply unit](#).

## Steps

1. Align the guide slots on the PIB with the four hooks on the system.
2. Slide PIB in to the guide hooks till the plunger click in place .

**NOTE:** The numbers on the image do not depict the exact steps. The numbers are for representation of sequence.

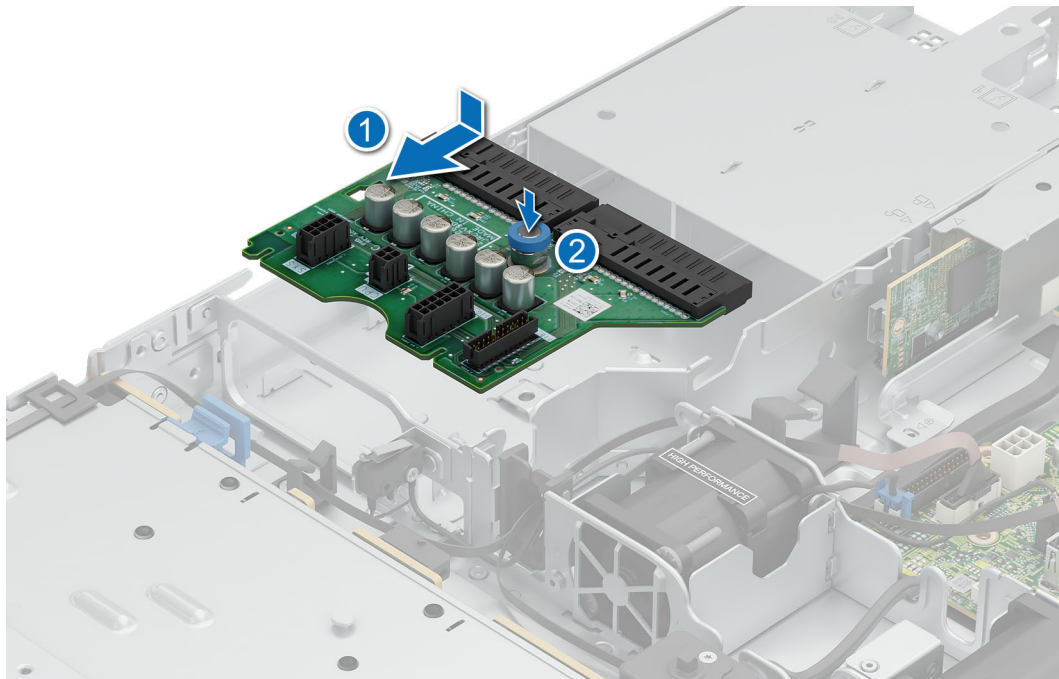

Figure 76. Installing the PIB

### Next steps

1. Install the power supply unit.
2. Install the air shroud.
3. Follow the procedure listed in [After working inside your system](#).

## System board

This is a service technician replaceable part only.

## Removing the system board

### Prerequisites

1. Follow the safety guidelines listed in [Safety instructions](#).
2. Follow the procedure listed in [Before working on your system](#).
3. Remove the following:

**CAUTION:** Do not lift the system board by holding a memory module, processor, or other components.

- a. [System cover](#).
- b. [Air shroud](#).
- c. [Memory modules](#).
- d. [Processor](#).
- e. [Heatsink](#).
- f. [Expansion card riser](#)(if installed).
- g. [Internal PERC card](#) or [Front PERC riser](#) (if installed).

### Steps

1. Disconnect all cables from the system board.
2. Loosen and remove the eight screws securing the system board.
3. Hold the system board holder and slide it toward the front of the chassis.



- Incline the system board at an angle, and lift the system board out of the chassis.

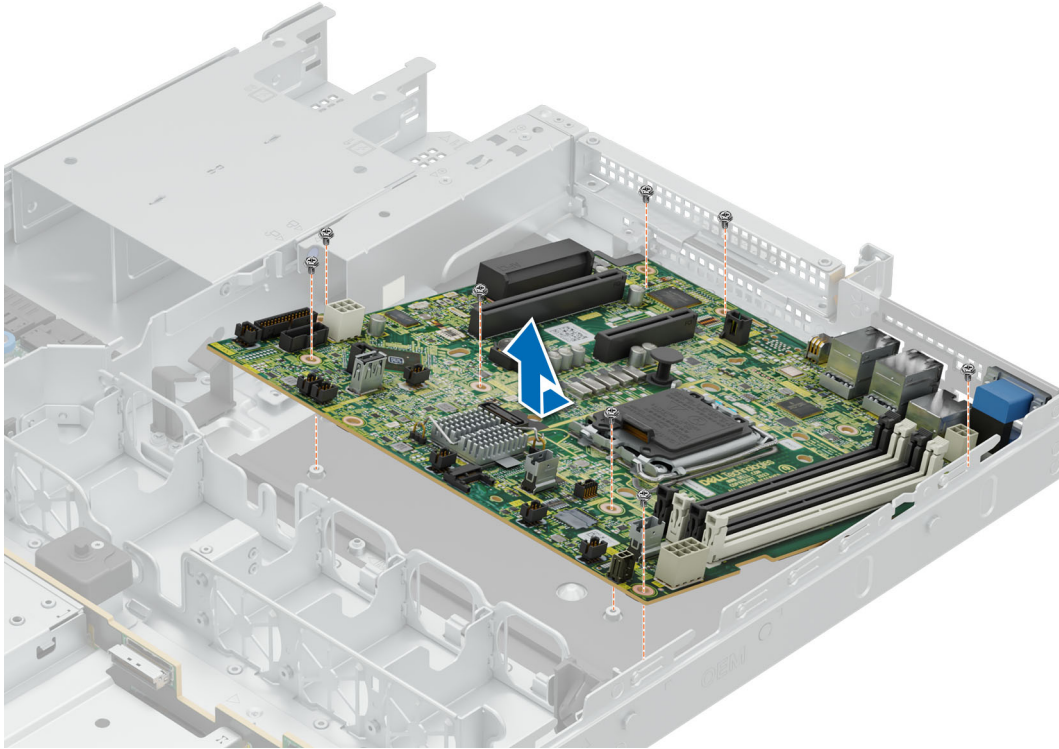

Figure 77. Removing the system board

### Next steps

Install the system board.

## Installing the system board

### Prerequisites

- Follow the safety guidelines listed in [Safety instructions](#).
- Follow the procedure listed in [Before working on your system](#)
- Remove the following:
  - [System cover](#).
  - [Air shroud](#).
  - [Memory modules](#).
  - [Processor](#).
  - [Heatsink](#).
  - [Expansion card riser](#) (if installed).
  - [Internal PERC card](#) or [Front PERC riser](#) (if installed).

### Steps

- Unpack the new system board.  
 **CAUTION: Do not lift the system board by holding a memory module, processor, or other components.**
- Holding the system board holder lower the system board in to the chassis.
- Incline the system board at an angle, align the connectors with the slots on the rear of the system and push the system board till firmly seated.
- Install and tighten the eight screws to secure the system board in place,

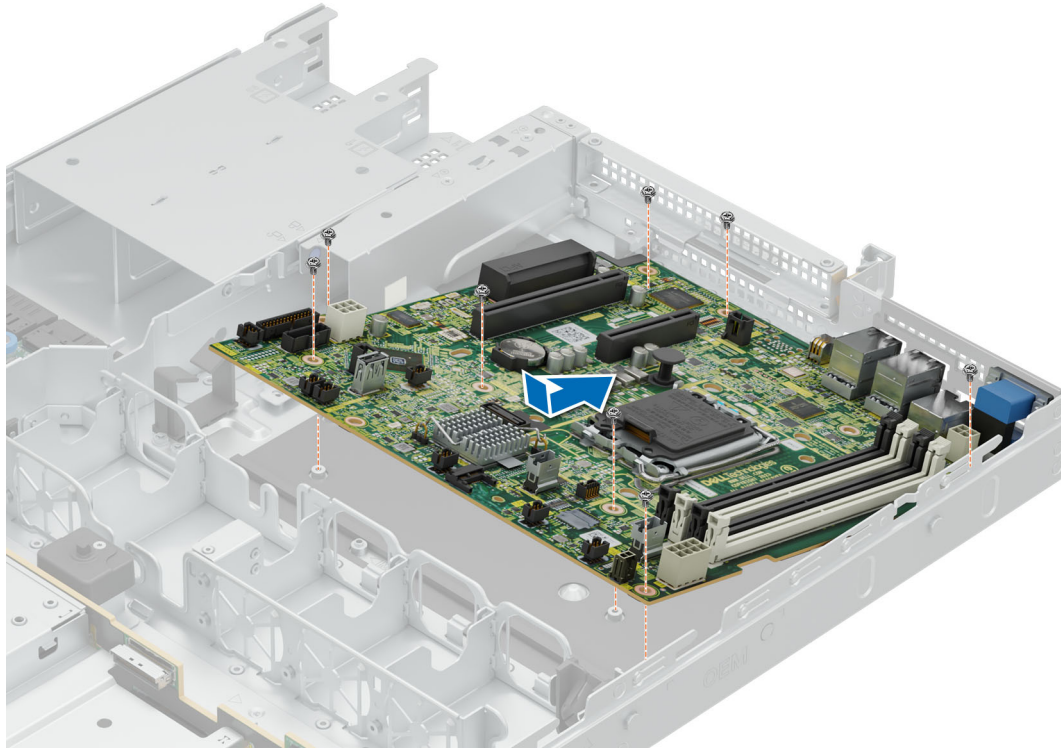

**Figure 78. Installing system board**

### Next steps

1. Replace the following:
  - a. [Trusted Platform Module \(TPM\)](#).
  - b. [Internal Perc card](#) or [Front PERC riser](#).
  - c. [Expansion card riser](#).
  - d. [Processor](#) (if removed).
  - e. [Heatsink](#) (if removed).
  - f. [Memory modules](#) (if installed).
2. Reconnect all cables to the system board.

**i** **NOTE:** Ensure that the cables inside the system are routed along the chassis wall and secured using the cable securing bracket.
3. [Install the air shroud](#).
4. [Install the system cover](#).
5. Ensure that you perform the following steps:
  - a. Use the Easy Restore feature to restore the Service Tag. See the [Restoring the system by using the Easy Restore feature](#) section.
  - b. If the service tag is not backed up in the backup flash device, enter the system service tag manually. See the [Manually update the Service Tag](#) by using System Setup section.
  - c. Update the BIOS and iDRAC versions.
  - d. Re-enable the Trusted Platform Module (TPM). See the [Upgrading the Trusted Platform Module](#) section.
6. Follow the procedure listed in [After working inside your system](#).

## Restoring the system using Easy Restore

The Easy Restore feature enables you to restore your service tag, license, UEFI configuration, and the system configuration data after replacing the system board. All data is backed up in a backup flash device automatically. If BIOS detects a new system board, and the service tag in the backup flash device, BIOS prompts the user to restore the backup information.



### About this task

Below is a list of options/steps available:

#### Steps

1. Restore the service tag, license, and diagnostics information, press **Y**
2. Navigate to the Lifecycle Controller based restore options, press **N**
3. Restore data from a previously created **Hardware Server Profile**, press **F10**

**i** **NOTE:** When the restore process is complete, BIOS prompts to restore the system configuration data.

4. Restore data from a previously created **Hardware Server Profile**, press **F10**
5. To restore the system configuration data, press **Y**
6. To use the default configuration settings, press **N**

**i** **NOTE:** After the restore process is complete, system reboots.

## Manually update the Service Tag

After replacing a system board, if Easy Restore fails, follow this process to manually enter the Service Tag, using **System Setup**.

### About this task

If you know the system service tag, use the **System Setup** menu to enter the service tag.

#### Steps

1. Power on the system.
2. To enter the **System Setup**, press **F2**.
3. Click **Service Tag Settings**.
4. Enter the service tag.

**i** **NOTE:** You can enter the service tag only when the **Service Tag** field is empty. Ensure that you enter the correct service tag. Once the service tag is entered, it cannot be updated or changed. Incorrectly entered service tag will lead to system board replacement.

5. Click **OK**.

## Trusted Platform Module

This is a service technician replaceable part only.

## Upgrading the Trusted Platform Module

### Removing the TPM

#### Prerequisites

1. Follow the safety guidelines listed in the [Safety instructions](#).
2. Follow the procedure listed in [Before working inside your system](#).

**i** **NOTE:**

- Ensure the operating system is compatible with the TPM version you are installing.
- Ensure that you download and install the latest BIOS firmware on your system.
- Ensure that the BIOS is configured to enable UEFI boot mode.

**CAUTION:** The TPM plug-in module is cryptographically bound to that particular system board after it is installed. When the system is powered on, any attempt to remove an installed TPM plug-in module breaks the cryptographic binding, and the removed TPM cannot be installed on another system board. Ensure any keys you have stored on the TPM have been securely transferred.

### Steps

1. Locate the TPM connector on the system board. For more information, see .
2. Press to hold the module down and remove the screw using the security Torx 8-bit shipped with the TPM module.
3. Slide the TPM module out from its connector.
4. Push the plastic rivet away from the TPM connector and rotate it 90° counterclockwise to release it from the system board.
5. Pull the plastic rivet out of its slot on the system board.

## Installing the TPM

### Prerequisites

1. Follow the safety guidelines listed in the [Safety instructions](#).
2. Follow the procedure listed in [Before working inside your system](#).

### Steps

1. To install the TPM, align the edge connectors on the TPM with the slot on the TPM connector.
2. Insert the TPM into the TPM connector such that the plastic rivet aligns with the slot on the system board.
3. Press the plastic rivet until the rivet snaps into place.
4. Replace the screw that secures the TPM to the system board.

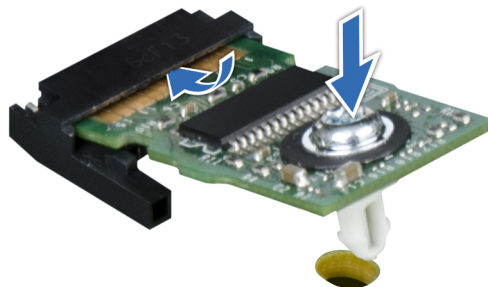

Figure 79. Installing the TPM

## Initializing TPM for users

### Steps

1. Initialize the TPM.  
For more information, see [Initializing the TPM 2.0 for users](#).
2. The **TPM Status** changes to **Enabled, Activated**.

## Initializing the TPM 2.0 for users

### Steps

1. While booting your system, press F2 to enter System Setup.
2. On the **System Setup Main Menu** screen, click **System BIOS > System Security Settings**.

3. From the **TPM Security** option, select **On**.
4. Save the settings.
5. Restart your system.

## Control panel

This is a service technician replaceable part only.

### Removing the right control panel

#### Prerequisites

1. Follow the safety guidelines listed in [Safety instructions](#).
2. Follow the procedure listed in [Before working on your system](#).
3. [Remove air shroud](#).

#### Steps

1. Disconnect the right control panel cable on the system board.

**i** **NOTE:** Observe the routing of the cable assembly as you remove the right control panel from the system.

2. Using the screwdriver, remove the two screws that secure the right control panel to the system.
3. Holding the right control panel and cable assembly, slide the right control panel out of the system.

**i** **NOTE:** The numbers on the image do not depict the exact steps. The numbers are for representation of sequence.

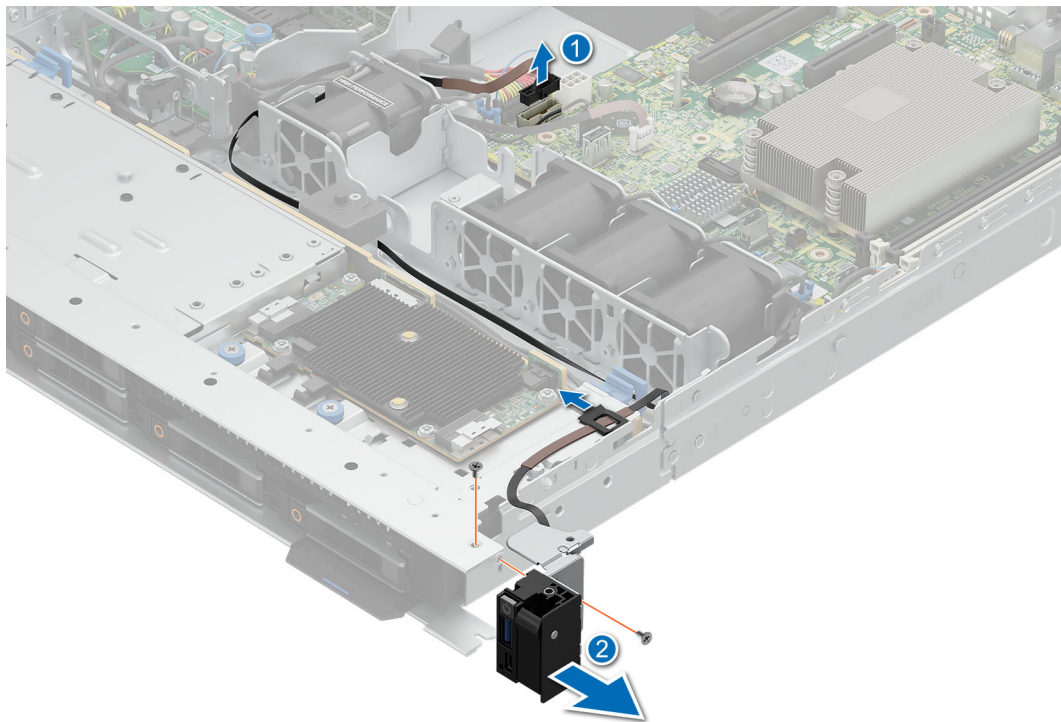

**Figure 80. Removing the right control panel**

#### Next steps

1. [Install the right control panel](#).

# Installing the right control panel

## Prerequisites

1. Follow the safety guidelines listed in [Safety instructions](#).
2. Follow the procedure listed in [Before working on your system](#).
3. [Remove air shroud](#).

## Steps

1. Align and slide the right control panel into the slot on the system.
2. Route the right control panel cable through the side wall of the system.

**NOTE:** Route the cable properly to prevent the cable from being pinched or crimped.

3. Connect the right control panel cable to the connector on the system board.
4. Using the screwdriver, tighten the two screws that secure the right control panel to the system.

**NOTE:** The numbers on the image do not depict the exact steps. The numbers are for representation of sequence.

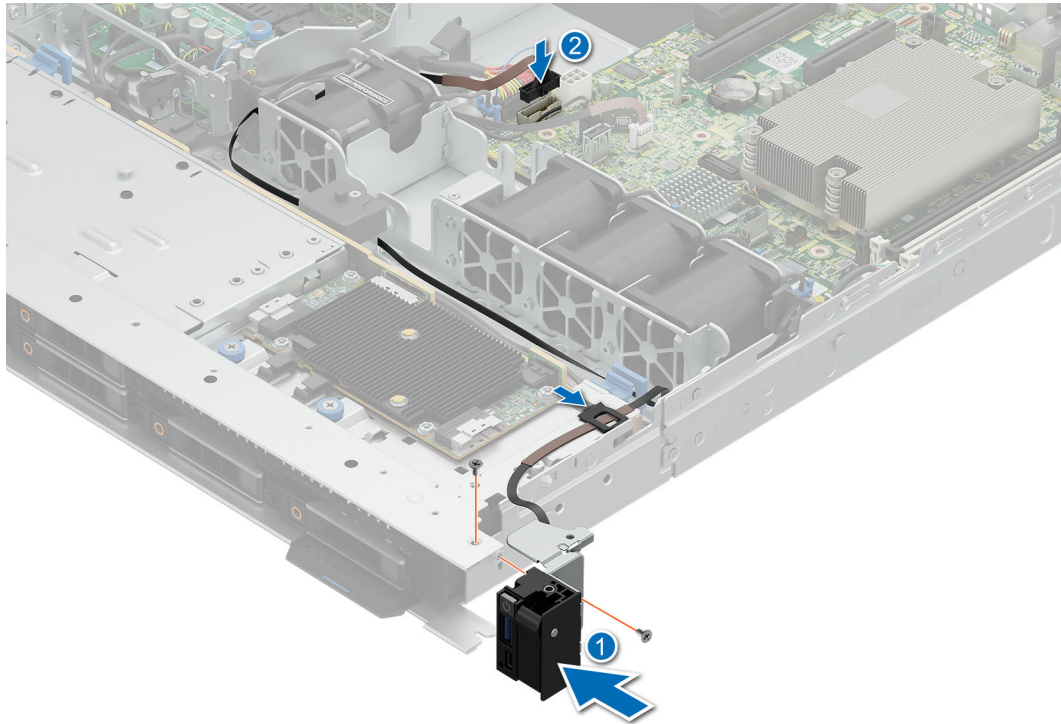

Figure 81. Installing the right control panel

## Next steps

1. [Install the air shroud](#).
2. Follow the procedure listed in [After working inside your system](#).

# Removing the left control panel

## Prerequisites

1. Follow the safety guidelines listed in [Safety instructions](#).
2. Follow the procedure listed in [Before working on your system](#).
3. [Remove system cover](#).

4. [Remove air shroud.](#)

### Steps

1. Disconnect the control panel cable from the connector on the system board.
2. Using the screwdriver, remove the three screws that secure the left control panel the system.
3. Holding the control panel , slide the left control panel out of the system.

**NOTE:** Observe the routing of the cable as you remove the left control panel from the system.

**NOTE:** The numbers on the image do not depict the exact steps. The numbers are for representation of sequence.

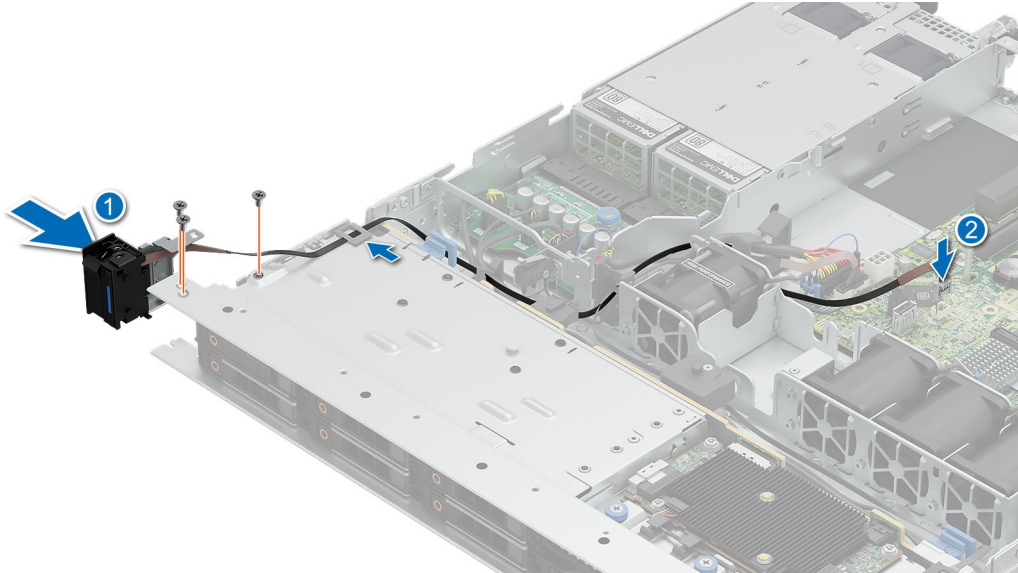

**Figure 82. Removing the left control panel**

### Next steps

1. [Install the left control panel.](#)

## Installing the left control panel

### Prerequisites

1. Follow the safety guidelines listed in [Safety instructions](#).
2. Follow the procedure listed in [Before working on your system](#).
3. [Remove air shroud.](#)

### Steps

1. Align and slide the left control panel in the slot on the system.
2. Using the screwdriver, tighten the three screws to secure the left control panel to the system.
3. Route the left control panel cable through the side wall of the system.

**NOTE:** Route the cable properly to prevent the cable from being pinched or crimped.

4. Connect the left control panel cable to the connector on the system board .

**NOTE:** The numbers on the image do not depict the exact steps. The numbers are for representation of sequence.

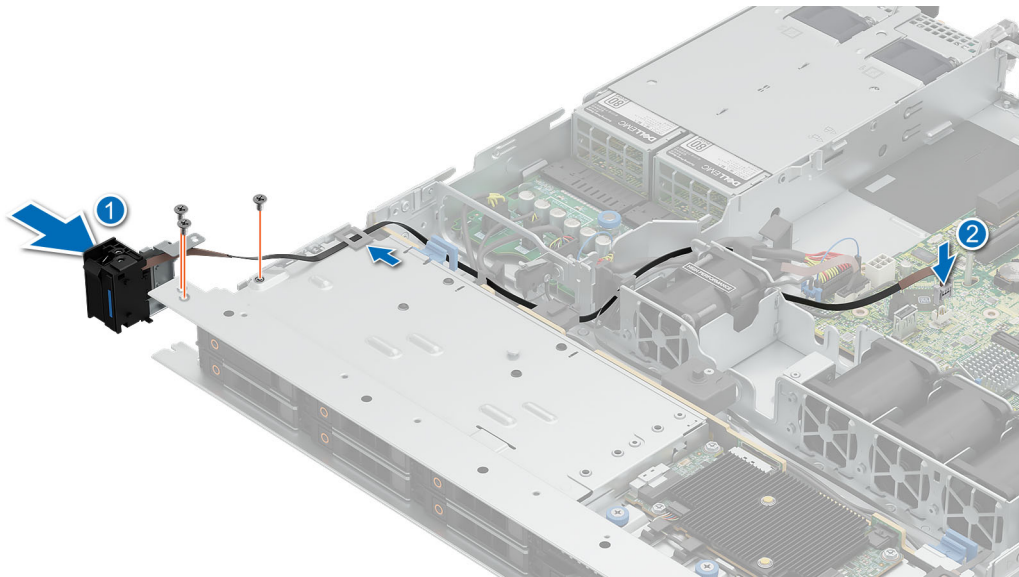

**Figure 83. Installing the left control panel**

**Next steps**

1. [Install the air shroud.](#)
2. Follow the procedure listed in [After working inside your system.](#)

# Upgrade Kits

The table lists the available After Point Of Sale [APOS] kits.

**Table 67. Upgrade kits**

Kits	Related links to service instructions
Memory	See <a href="#">Installing a memory module</a>
SSD	See <a href="#">Installing the drive</a>
GPU	See <a href="#">GPU kit</a>
Processor	See <a href="#">Installing the processor</a>
Heat sink	See <a href="#">Installing the heatsink</a>
Storage controller card	See <a href="#">Installing the expansion car into the the expansion card riser</a> or <a href="#">installing the PERC card to the internal slot</a>
HBA	
Network card	
Power supplies	See <a href="#">Installing a power supply unit</a>
Cables	See <a href="#">cable routing</a>
Bezel	See <a href="#">Installing the front bezel</a>
Expansion Card	See <a href="#">installing the expansion card riser</a>
Power cords	NA
BOSS-N1	See <a href="#">Installing the BOSS N1 module</a>

## Topics:

- [BOSS-N1 module kit](#)
- [GPU kit](#)
- [Filter bezel kit](#)

## BOSS-N1 module kit

The BOSS-N1 module supports up to two M.2 NVMe SSDs.

Before you begin the installation or removal process, follow the [safety guidelines](#) and [before working inside the system](#) instructions.

**Table 68. BOSS-N1 module kit components**

Components in kit	R360 (quantity)
BOSS-N1 controller card module	1
BOSS-N1 card carrier	1 or 2*
M.2 NVMe SSD	1 or 2*
M.2 NVMe SSD capacity label	1 or 2†
BOSS-N1 card carrier blank	1
M3 x 0.5 x 4.5 mm screws	1



**Table 68. BOSS-N1 module kit components (continued)**

Components in kit	R360 (quantity)
BOSS-N1 signal cable for mother board (270 mm)	1
BOSS-N1 power cable for mother board (305 mm)	1

**NOTE:** \*The quantity depends on the purchase order.

**NOTE:** †The quantity depends on the BOSS-N1 card carrier.

To remove the BOSS blank :

1. Power off the system
2. Pull the BOSS N1 blank out of the system to remove it.

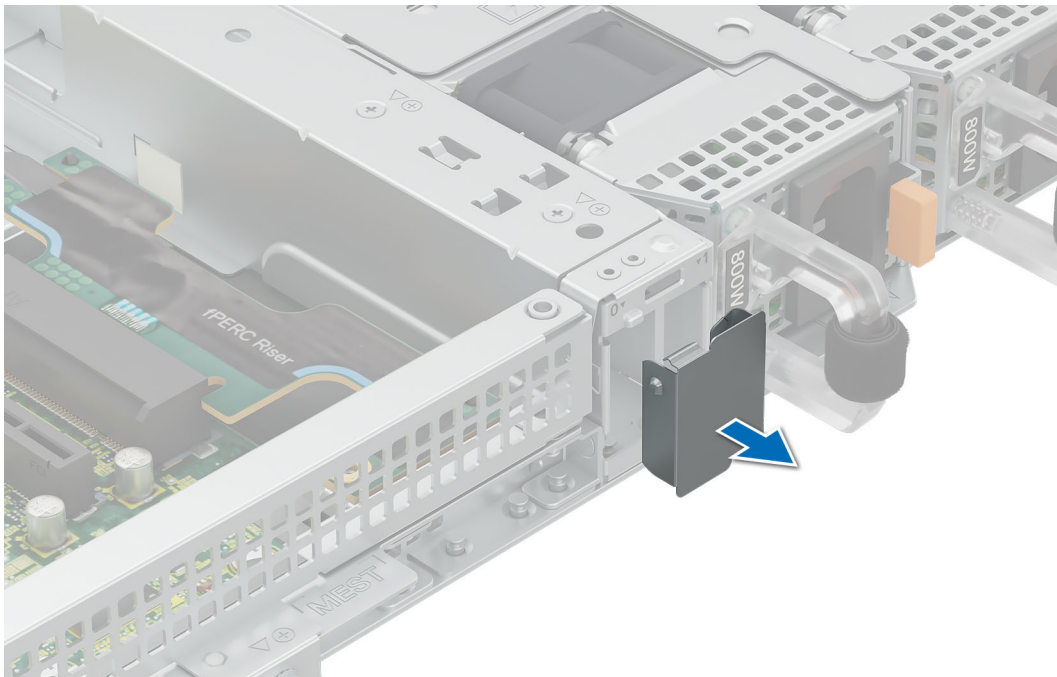

**Figure 84. Removing the BOSS-N1 module blank**

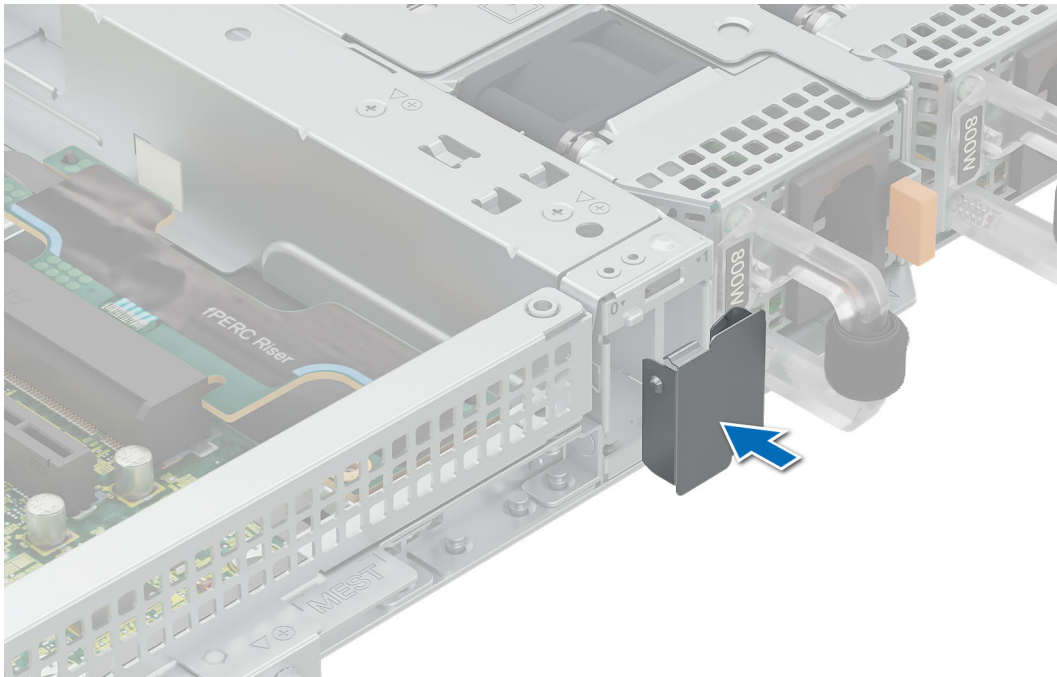

**Figure 85. Installing the BOSS-N1 module blank**

To install the BOSS-N1 module:

1. To install the BOSS-N1 module , see [Install the BOSS N1 module](#) .

**i** **NOTE:** Refer to [cable routing](#) section for BOSS N1 cable connections.

**i** **NOTE:** Installing the BOSS-N1 card carrier does not require the system to be powered off. System shutdown is only required when installing the BOSS-N1 controller card module.

**i** **NOTE:** BOSS N1 module cannot be installed if the system has an internal adapter PERC card installed.

# GPU kit

The GPU SW kit is available for the Customer. Depending on the kit ordered, the respective components are available.

**CAUTION:** Do not install GPUs, network cards, or other PCIe devices on your system that are not validated and tested by Dell. Damage caused by unauthorized and invalidated hardware installation will null and void the system warranty.

**WARNING:** Consumer-Grade GPU should not be installed or used in the Enterprise Server products.

**Table 69. Components in the full length (FL) GPU kit**

Components	GPU kit	
	Details	Quantity
Risers	Riser configuration (RC) 1 or 2	1
Shroud	GPU shroud	NA
Fans	HPR Silver fan	1
Heat sinks	Standard or Performance heatsink based on the processor wattage	1
Cables	Power cable	NA

FL - Full Length, HL - Half Length, HPR - High Performance, RC - Riser configuration

**NOTE:** Adding GPUs to a system may increase the power envelope of that configuration beyond the current power supplies rated capability. Confirm power increase and upgrade PSU as needed to avoid negative impact on performance.

**NOTE:** The power cable is imprinted with a silkscreen indicating which connector on the system board and to which GPU it should be connected. See the GPU power cable matrix table below for the power cable required for your GPU.

**NOTE:** See [expansion card installation guidelines](#) for more information about riser configuration supported for the system.

Before you begin, follow the [safety guidelines](#) and [before working inside the system](#) instructions.

1. Install the High performance silver (HPR) cooling fan.
2. [Remove the air shroud.](#)
3. Install the GPU into the full butterfly riser, see [install an expansion card into the riser.](#)

**NOTE:** See [Install an expansion card riser it the system](#) into the system.

**NOTE:** For information about riser slot location on the system board, see the [system board jumpers and connectors](#) section.

4. If applicable, connect the power cables to the GPU. To know the connectors for the GPU on the system board, see the [system board jumpers and connectors](#) section.

See the GPU power cable matrix to know about the requirement of cables for the GPU.

**NOTE:** A maximum of one SW GPU is supported on the system.

After installing, follow the [After working inside the system](#) instructions.

# Filter bezel kit

## Prerequisites

The filter bezel kit and replacement filter media kit are available for the Customer. Depending on the kit ordered, the respective components are available.

**Table 70. Components in the filter bezel kit**

Components	Filter Bezel kit	
	Details	Quantity
Filter Bezel	Filter Bezel	1
Filter Media	Filter Media	1

**Table 71. Components in the replacement filter media kit**

Components	Filter Bezel kit	
	Details	Quantity
Filter Media	Filter Media	4

**NOTE:** To maintain optimal system health, Dell Technologies recommends checking and changing the filter media every 3-6 months. Filter media can be ordered from Dell.

Before you begin, follow the [safety guidelines](#) and [before working inside the system](#) instructions.

**Steps**

1. If installed [Remove the security bezel](#) and keep it safe.
2. Loosen and remove the two screws to take out the bracket from the filter bezel.
3. Insert the filter media.
4. Replace the bracket and tighten the two screws to secure it in place.
5. Insert the right side of the filter bezel in to the groove on the system.
6. Press the button on the left side of the filter bezel and install it on the system.

**NOTE:** The numbers on the image do not depict the exact steps. The numbers are for representation of sequence.

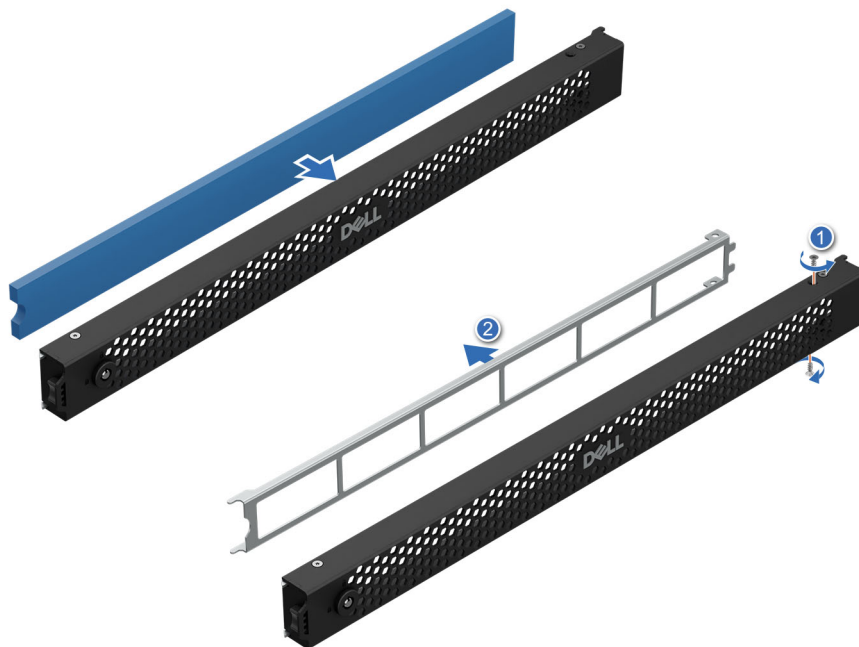

**Figure 86. Installing the filter**

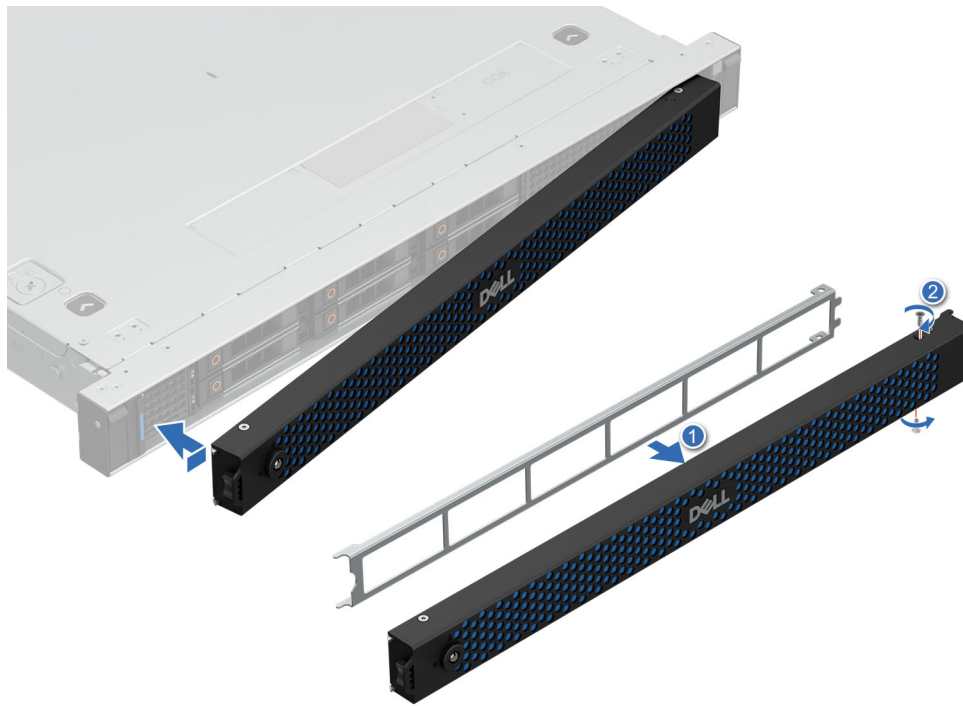

**Figure 87. Installing the filter bezel**

**Next steps**

After installing, follow the [After working inside the system](#) instructions.

# Jumpers and connectors

This topic provides some basic and specific information about jumpers and switches. It also describes the connectors on the various boards in the system. Jumpers on the system board help to disable the system and reset the passwords. To install components and cables correctly, you must know the connectors on the system board.

## Topics:

- System board jumpers and connectors
- System board jumper settings
- Disabling a forgotten password

## System board jumpers and connectors

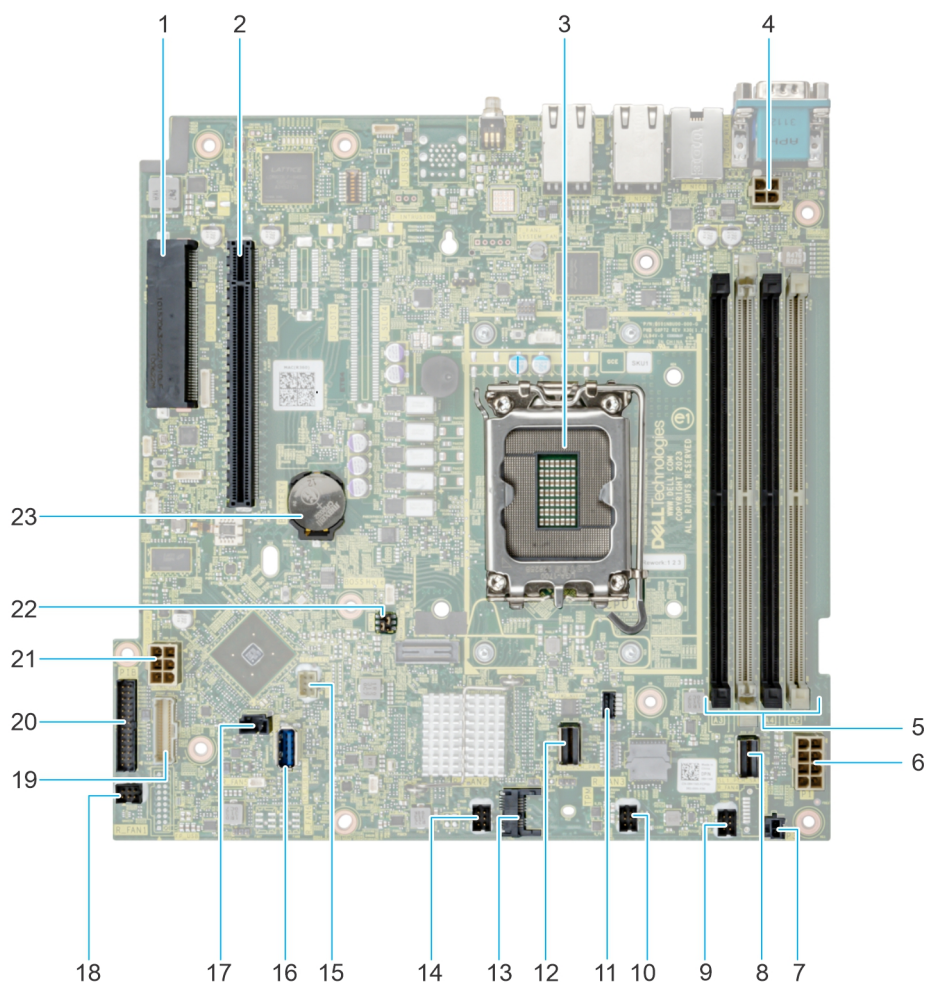

Figure 88. System board jumpers and connectors

Table 72. System board jumpers and connectors

Item	Connector	Description
1.	InternalPERC connector	Connector for internal PERC and fPERC riser





**Table 72. System board jumpers and connectors (continued)**

Item	Connector	Description
2.	Riser connector	Connector for the riser
3.	CPU slot	Slot for CPU
4.	CPU power	Power connector for CPU
5.	DIMMs	DIMM connectors
6.	Power connector	Power connector for system board
7.	PSU event signal cable	Connector for PSU event signal cable
8.	SATA connector (SL1_PCH_SA1)	SATA connector 1
9.	Fan 4	Connector for Fan 4
10.	Fan 3	Connector for Fan 3
11.	BOSS card power	Power connector for BOSS card
12.	BOSS connector (SL2_PCH_PA2)	Connector for BOSS cable
13.	TPM	TPM connector
14.	Fan 2	Connector for Fan 2
15.	Left Control Panel	Left Control Panel Connector
16.	Internal USB	USB 3.2 Gen1 port
17.	Intrusion switch	Intrusion switch connector
18.	Fan 1	Connector for Fan 1
19.	Right Control Panel	Right Control Panel Connector
20.	PIB	PIB connector
21.	HDD power	Power connector for HDD
22.	PWRD_EN and NVRAM_CLR Jumper	Jumper to clear passwords
23.	Coin cell battery	System CMOS battery

## System board jumper settings

For information about resetting the password jumper to disable a password, see the [disabling a forgotten password](#) section.

**Table 73. System board jumper settings**

Jumper	Setting	Description
PWRD_EN	 2 4 6 (default)	The BIOS password feature is enabled.
	 2 4 6	The BIOS password feature is disabled. The BIOS password is now disabled, and you are not allowed to set a new password.
NVRAM_CLR	 1 3 5 (default)	The BIOS configuration settings are retained at system boot.
	 1 3 5	The BIOS configuration settings are cleared at system boot.

**CAUTION:** You should be cautious when changing the BIOS settings. The BIOS interface is designed for advanced users. Any changes in the setting might prevent your system from starting correctly and may even result in data loss.





# Disabling a forgotten password

The software security features of the system include a system password and a setup password. The password jumper enables or disables password features and clears any password(s) currently in use.

## Prerequisites

 **CAUTION:** Many repairs may only be done by a certified service technician. You should only perform troubleshooting and simple repairs as authorized in your product documentation, or as directed by the online or telephone service and support team. Damage due to servicing that is not authorized by Dell is not covered by your warranty. Read and follow the safety instructions that are shipped with your product.

## Steps

1. Power off the system and all attached peripherals. Disconnect the system from the electrical outlet, and disconnect the peripherals.
2. [Remove the system cover.](#)
3. Move the jumper on the system board from pins 2 and 4 to pins 4 and 6.
4. [Replace the system cover.](#)
  -  **NOTE:** The existing passwords are not disabled (erased) until the system boots with the jumper on pins 4 and 6. However, before you assign a new system and/or setup password, you must move the jumper back to pins 2 and 4.
  -  **NOTE:** If you assign a new system and/or setup password with the jumper on pins 4 and 6, the system disables the new password(s) the next time it boots.
5. Reconnect the peripherals and connect the system to the electrical outlet, and then power on the system.
6. Power off the system.
7. [Remove the system cover.](#)
8. Move the jumper on the system board from pins 4 and 6 to pins 2 and 4.
9. [Replace the system cover.](#)
10. Reconnect the peripherals and connect the system to the electrical outlet, and then power on the system.
11. Assign a new system and/or setup password.

# System diagnostics and indicator codes

The diagnostic indicators on the system front panel display system status during system startup.

## Topics:

- Status LED indicators
- System health and system ID indicator codes
- iDRAC Direct LED indicator codes
- NIC indicator codes
- Power supply unit indicator codes
- Drive indicator codes
- Power button LED

## Status LED indicators

**NOTE:** The indicators display solid amber if any error occurs.

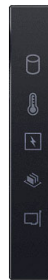



Figure 89. Status LED indicators

Table 74. Status LED indicators and descriptions

Icon	Description	Condition	Corrective action
	Drive indicator	The indicator turns solid amber if there is a drive error.	<ul style="list-style-type: none"> <li>• Check the System Event Log to determine if the drive has an error.</li> <li>• Run the appropriate Online Diagnostics test. Restart the system and run embedded diagnostics (ePSA).</li> <li>• If the drives are configured in a RAID array, restart the system, and enter the host adapter configuration utility program.</li> </ul>
	Temperature indicator	The indicator turns solid amber if the system experiences a thermal error (for example, the ambient temperature is out of range or there is a fan failure).	<p>Ensure that none of the following conditions exist:</p> <ul style="list-style-type: none"> <li>• A cooling fan has been removed or has failed.</li> <li>• System cover, air shrouds, or back filler bracket has been removed.</li> <li>• Ambient temperature is too high.</li> <li>• External airflow is obstructed.</li> </ul> <p>If the problem persists, see the <a href="#">Getting help</a> section.</p>
	Electrical indicator	The indicator turns solid amber if the system experiences an electrical error (for example,	Check the System Event Log or system messages for the specific issue. If it is due to a problem with

**Table 74. Status LED indicators and descriptions (continued)**

Icon	Description	Condition	Corrective action
		voltage out of range, or a failed power supply unit (PSU) or voltage regulator).	the PSU, check the LED on the PSU. Reseat the PSU. If the problem persists, see the <a href="#">Getting help</a> section.
	Memory indicator	The indicator turns solid amber if a memory error occurs.	Check the System Event Log or system messages for the location of the failed memory. Reseat the memory module. If the problem persists, see the <a href="#">Getting help</a> section.
	PCIe indicator	The indicator turns solid amber if a PCIe card experiences an error.	Restart the system. Update any required drivers for the PCIe card. Reinstall the card. If the problem persists, see the <a href="#">Getting help</a> section.

## System health and system ID indicator codes

The system health and system ID indicator is located on the left control panel of the system.



**Figure 90. System health and system ID indicator**

**Table 75. System health and system ID indicator codes**

System health and system ID indicator code	Condition
Solid blue	Indicates that the system is powered on, is healthy, and system ID mode is not active. Press the system health and system ID button to switch to system ID mode.
Blinking blue	Indicates that the system ID mode is active. Press the system health and system ID button to switch to system health mode.
Solid amber	Indicates that the system is in fail-safe mode. If the problem persists, see the <a href="#">Getting help</a> section.
Blinking amber	Indicates that the system is experiencing a fault. Check the System Event Log for specific error messages. For information about the event and error messages generated by the system firmware and agents that monitor system components, go to <a href="#">QRL &gt; Look Up &gt; Error Code</a> , type the error code, and then click <b>Look it up</b> .

## iDRAC Direct LED indicator codes

The iDRAC Direct LED indicator lights up to indicate that the port is connected and is being used as a part of the iDRAC subsystem.

You can configure iDRAC Direct by using a USB to micro USB (type AB) cable, which you can connect to your laptop or tablet. Cable length should not exceed three feet (0.91 meters). Performance could be affected by cable quality. The following table describes iDRAC Direct activity when the iDRAC Direct port is active:

**Table 76. iDRAC Direct LED indicator codes**

iDRAC Direct LED indicator code	Condition
Solid green for two seconds	Indicates that the laptop or tablet is connected.
Blinking green (on for two seconds and off for two seconds)	Indicates that the laptop or tablet connected is recognized.
LED Indicator off	Indicates that the laptop or tablet is unplugged.

## NIC indicator codes

Each NIC on the back of the system has indicators that provide information about the activity and link status. The activity LED indicator indicates if data is flowing through the NIC, and the link LED indicator indicates the speed of the connected network.

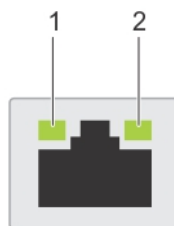

**Figure 91. NIC indicator codes**

1. Link LED indicator
2. Activity LED indicator

**Table 77. NIC indicator codes**

NIC indicator codes	Condition
Link and activity indicators are off.	Indicates that the NIC is not connected to the network.

**Table 77. NIC indicator codes (continued)**

NIC indicator codes	Condition
Link indicator is green, and activity indicator is blinking green.	Indicates that the NIC is connected to a valid network at its maximum port speed, and data is being sent or received.
Link indicator is amber, and activity indicator is blinking green.	Indicates that the NIC is connected to a valid network at less than its maximum port speed, and data is being sent or received.
Link indicator is green, and activity indicator is off.	Indicates that the NIC is connected to a valid network at its maximum port speed, and data is not being sent or received.
Link indicator is amber, and activity indicator is off.	Indicates that the NIC is connected to a valid network at less than its maximum port speed, and data is not being sent or received.
Link indicator is blinking green, and activity is off.	Indicates that the NIC identity is enabled through the NIC configuration utility.

## Power supply unit indicator codes

AC and DC power supply units (PSUs) have an illuminated translucent handle that serves as an indicator. The indicator shows if power is present or if a power fault has occurred.

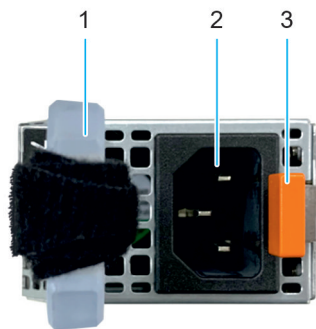

**Figure 92. AC PSU status indicator**

1. AC PSU handle
2. Socket
3. Release latch

**Table 78. PSU status indicator codes**

Power indicator codes	Condition
Green	Indicates that a valid power source is connected to the PSU and the PSU is operational.
Blinking amber	Indicates an issue with the PSU.
Not powered on	Indicates that the power is not connected to the PSU.
Blinking green	Indicates that the firmware of the PSU is being updated. <b>⚠ CAUTION: Do not disconnect the power cord or unplug the PSU when updating firmware. If firmware update is interrupted, the PSUs will not function.</b>
Blinking green and powers off	When hot-plugging a PSU, it blinks green five times at a rate of 4 Hz and powers off. This indicates a PSU mismatch due to efficiency, feature set, health status, or supported voltage. <b>⚠ CAUTION: If two PSUs are installed, both the PSUs must have the same type of label; for example, Extended Power Performance (EPP) label. Mixing</b>

**Table 78. PSU status indicator codes (continued)**

Power indicator codes	Condition
	<p>PSUs from previous generations of PowerEdge servers is not supported, even if the PSUs have the same power rating. This results in a PSU mismatch condition or failure to power on the system.</p> <p>⚠ <b>CAUTION:</b> If two PSUs are used, they must be of the same type and have the same maximum output power.</p> <p>⚠ <b>CAUTION:</b> When correcting a PSU mismatch, replace the PSU with the blinking indicator. Swapping the PSU to make a matched pair can result in an error condition and an unexpected system shutdown. To change from a high output configuration to a low output configuration or vice versa, you must power off the system.</p> <p>⚠ <b>CAUTION:</b> AC PSUs support both 240 V and 120 V input voltages with the exception of Titanium PSUs, which support only 240 V. When two identical PSUs receive different input voltages, they can output different wattages, and trigger a mismatch.</p>

## Drive indicator codes

The LEDs on the drive carrier indicate the state of each drive. Each drive carrier has two LEDs: an activity LED (green) and a status LED (bicolor, green/amber). The activity LED blinks whenever the drive is accessed.



**Figure 93. Drive indicators**

1. Drive activity LED indicator
2. Drive status LED indicator
3. Drive capacity label

ⓘ **NOTE:** If the drive is in the Advanced Host Controller Interface (AHCI) mode, the status LED indicator does not power on.

ⓘ **NOTE:** Drive status indicator behavior is managed by Storage Spaces Direct. Not all drive status indicators may be used.

**Table 79. Drive indicator codes**

Drive status indicator code	Condition
Blinks green twice per second	Indicates that the drive is being identified or preparing for removal.
Not powered on	Indicates that the drive is ready for removal. ⓘ <b>NOTE:</b> The drive status indicator remains off until all drives are initialized after the system is powered on. Drives are not ready for removal during this time.

**Table 79. Drive indicator codes (continued)**

Drive status indicator code	Condition
Blinks green, amber, and then powers off	Indicates that there is an unexpected drive failure.
Blinks amber four times per second	Indicates that the drive has failed.
Blinks green slowly	Indicates that the drive is rebuilding.
Solid green	Indicates that the drive is online.
Blinks green for three seconds, amber for three seconds, and then powers off after six seconds	Indicates that the rebuild has stopped.

## Power button LED

The power button LED is located on the front panel of your system.



**Figure 94. Power button LED**

**Table 80. Power button LED**

Power button LED indicator code	Condition
Off	System is not operating, regardless of power supply available.
On	System is operating, one or more of the non-standby power supply units are active.
Slowly blinking	System is performing powering on sequence and iDRAC is still booting.



# Using system diagnostics

If you experience an issue with the system, run the system diagnostics before contacting Dell for technical assistance. The purpose of running system diagnostics is to test the system hardware without using additional equipment or risking data loss. If you are unable to fix the issue yourself, service and support personnel can use the diagnostics results to help you solve the issue.

## Topics:

- [Dell Embedded System Diagnostics](#)

## Dell Embedded System Diagnostics

 **NOTE:** The Dell Embedded System Diagnostics is also known as Enhanced Pre-boot System Assessment (ePSA) diagnostics.

The Embedded System Diagnostics provide a set of options for particular device groups or devices allowing you to:

- Run tests automatically or in an interactive mode
- Repeat tests
- Display or save test results
- Run thorough tests to introduce additional test options to provide extra information about the failed device(s)
- View status messages that inform you if tests are completed successfully
- View error messages that inform you of issues encountered during testing

## Running the Embedded System Diagnostics from Boot Manager

Run the Embedded System Diagnostics (ePSA) if your system does not boot.

### Steps

1. When the system is booting, press F11.
2. Use the up arrow and down arrow keys to select **System Utilities > Launch Diagnostics**.
3. Alternatively, when the system is booting, press F10, select **Hardware Diagnostics > Run Hardware Diagnostics**.  
The **ePSA Pre-boot System Assessment** window is displayed, listing all devices detected in the system. The diagnostics starts executing the tests on all the detected devices.

## Running the Embedded System Diagnostics from the Dell Lifecycle Controller

### Steps

1. When the system is booting, press F10.
2. Select **Hardware Diagnostics → Run Hardware Diagnostics**.  
The **ePSA Pre-boot System Assessment** window is displayed, listing all devices detected in the system. The diagnostics start executing the tests on all the detected devices.

## System diagnostic controls

Table 81. System diagnostic controls

Menu	Description
Configuration	Displays the configuration and status information of all detected devices.
Results	Displays the results of all tests that are run.
System health	Provides the current overview of the system performance.
Event log	Displays a time-stamped log of the results of all tests run on the system. This is displayed if at least one event description is recorded.

## Getting help

### Topics:

- [Recycling or End-of-Life service information](#)
- [Contacting Dell Technologies](#)
- [Accessing system information by using QRL](#)
- [Receiving automated support with Secure Connect Gateway \(SCG\)](#)

## Recycling or End-of-Life service information

Take back and recycling services are offered for this product in certain countries. If you want to dispose of system components, visit [How to Recycle](#) and select the relevant country.

## Contacting Dell Technologies

Dell provides online and telephone based support and service options. If you do not have an active internet connection, you can find Dell contact information on your purchase invoice, packing slip, bill or Dell product catalog. The availability of services varies depending on the country and product, and some services may not be available in your area. To contact Dell for sales, technical assistance, or customer service issues follow these steps:

### Steps

1. Go to [Dell Support](#).
2. Select your country from the drop-down menu on the lower right corner of the page.
3. For customized support:
  - a. Enter the system Service Tag in the **Enter a Service Tag, Serial Number, Service Request, Model, or Keyword** field.
  - b. Click **Search**.  
The support page that lists the various support categories is displayed.
4. For general support:
  - a. Select your product category.
  - b. Select your product segment.
  - c. Select your product.  
The support page that lists the various support categories is displayed.
5. For contact details of Dell Global Technical Support:
  - a. Click [Contact Technical Support](#).
  - b. The **Contact Technical Support** page is displayed with details to call, chat, or e-mail the Dell Global Technical Support team.

## Accessing system information by using QRL

There is also another QRL for accessing product information on the back of the system cover.

### Prerequisites

Ensure that your smartphone or tablet has a QR code scanner installed.

The QRL includes the following information about your system:

- How-to videos

- Reference materials, including the Installation and Service Manual, and mechanical overview
- The system service tag to quickly access the specific hardware configuration and warranty information
- A direct link to Dell to contact technical assistance and sales teams

#### Steps

1. Go to [qrl](#), and navigate to your specific product or
2. Use your smart phone or tablet to scan the model-specific Quick Resource (QR) code on your system or in the Quick Resource Locator section.

## Quick Resource Locator for PowerEdge R360 system



Figure 95. Quick Resource Locator for PowerEdge R360 system

## Receiving automated support with Secure Connect Gateway (SCG)

Dell Secure Connect Gateway (SCG) is an optional Dell Services offering that automates technical support for your Dell server, storage, and networking devices. By installing and setting up a Secure Connect Gateway (SCG) application in your IT environment, you can receive the following benefits:

- Automated issue detection — Secure Connect Gateway (SCG) monitors your Dell devices and automatically detects hardware issues, both proactively and predictively.
- Automated case creation — When an issue is detected, Secure Connect Gateway (SCG) automatically opens a support case with Dell Technical Support.
- Automated diagnostic collection — Secure Connect Gateway (SCG) automatically collects system state information from your devices and uploads it securely to Dell. This information is used by Dell Technical Support to troubleshoot the issue.
- Proactive contact — A Dell Technical Support agent contacts you about the support case and helps you resolve the issue.

The available benefits vary depending on the Dell Service entitlement purchased for your device. For more information about Secure Connect Gateway (SCG), go to [secureconnectgateway](#).

## Documentation resources

This section provides information about the documentation resources for your system.

To view the document that is listed in the documentation resources table:

- From the Dell support site:
  1. Click the documentation link that is provided in the Location column in the table.
  2. Click the required product or product version.
-  **NOTE:** To locate the model number, see the front of your system.
- 3. On the Product Support page, click **Documentation**.
- Using search engines:
  - Type the name and version of the document in the search box.

**Table 82. Additional documentation resources for your system**

Task	Document	Location
Setting up your system	For information about setting up your system, see the <i>Getting Started Guide</i> document that is shipped with your system.	<a href="#">PowerEdge Manuals</a>
Configuring your system	For information about the iDRAC features, configuring and logging in to iDRAC, and managing your system remotely, see the Integrated Dell Remote Access Controller User's Guide.	<a href="#">PowerEdge Manuals</a>
	For information about understanding Remote Access Controller Admin (RACADM) subcommands and supported RACADM interfaces, see the RACADM CLI Guide for iDRAC.	
	For information about Redfish and its protocol, supported schema, and Redfish Eventing implemented in iDRAC, see the Redfish API Guide.	
	For information about iDRAC property database group and object descriptions, see the Attribute Registry Guide.	
	For information about Intel QuickAssist Technology, see the Integrated Dell Remote Access Controller User's Guide.	
	For information about earlier versions of, the iDRAC documents.  To identify the version of iDRAC available on your system, on the iDRAC web interface, click <b>? &gt; About</b> .	<a href="#">iDRAC Manuals</a>
	For information about installing the operating system, see the operating system documentation.	<a href="#">Operating System Manuals</a>
	For information about updating drivers and firmware, see the Methods to download firmware and drivers section in this document.	<a href="#">Drivers</a>

**Table 82. Additional documentation resources for your system (continued)**

Task	Document	Location
Managing your system	For information about systems management software offered by Dell, see the Dell OpenManage Systems Management Overview Guide.	<a href="#">PowerEdge Manuals</a>
	For information about setting up, using, and troubleshooting OpenManage, see the Dell OpenManage Server Administrator User's Guide.	<a href="#">OpenManage Manuals</a>
	For information about installing and using Dell Secure Connect Gateway, see the Dell Secure Connect Gateway Enterprise User's Guide.	<a href="#">serviceability tools</a>
	For information about partner programs enterprise systems management, see the OpenManage Connections Enterprise Systems Management documents.	<a href="#">OpenManage Manuals</a>
Working with the Dell PowerEdge RAID controllers (if applicable)	For information about understanding the features of the Dell PowerEdge RAID controllers (PERC), Software RAID controllers, or BOSS card and deploying the cards, see the Storage controller documentation.	<a href="#">Storage Controller Manuals</a>
Understanding event and error messages	For information about the event and error messages generated by the system firmware and agents that monitor system components, go to <a href="#">QRL</a> > <b>Look Up</b> > <b>Error Code</b> , type the error code, and then click <b>Look it up</b> .	<a href="#">QRL</a>
Troubleshooting your system	For information about identifying and troubleshooting the PowerEdge server issues, see the Server Troubleshooting Guide.	<a href="#">PowerEdge Manuals</a>