

Latitude 3550

Owner's Manual

Notes, cautions, and warnings

 **NOTE:** A NOTE indicates important information that helps you make better use of your product.

 **CAUTION:** A CAUTION indicates either potential damage to hardware or loss of data and tells you how to avoid the problem.

 **WARNING:** A WARNING indicates a potential for property damage, personal injury, or death.

Chapter 1: Set up your Latitude 3550	7
Chapter 2: Views of Latitude 3550	9
Right	9
Left	9
Top	10
Front	11
Bottom	12
Service Tag	12
Battery charge and status light	13
Chapter 3: Specifications of Latitude 3550	14
Dimensions and weight	14
Processor	14
Chipset	15
Operating system	15
Memory	15
External ports	16
Internal slots	16
Ethernet	17
Wireless module	17
WWAN module	17
Audio	18
Storage	19
Keyboard	19
Keyboard shortcuts of Latitude 3550	20
Camera	22
Touchpad	22
Power adapter	23
Battery	24
Display	25
Fingerprint reader	26
Sensor	26
GPU—Integrated	26
GPU—Discrete	27
Multiple display support matrix	27
Hardware security	27
Operating and storage environment	27
Chapter 4: Working inside your computer	29
Safety instructions	29
Before working inside your computer	29
Safety precautions	30
Electrostatic discharge—ESD protection	30

ESD Field Service kit	31
Transporting sensitive components.....	32
After working inside your computer.....	32
BitLocker.....	32
Recommended tools.....	32
Screw list.....	33
Major components of Latitude 3550.....	34
Chapter 5: Removing and installing Customer Replaceable Units (CRUs).....	37
Base cover.....	37
Removing the base cover.....	37
Installing the base cover.....	39
Memory module.....	40
Removing the memory module.....	40
Installing the memory modules.....	41
Wireless card.....	42
Removing the wireless card.....	42
Installing the wireless card.....	43
Wireless Wide Area Network (WWAN) card.....	45
Removing the WWAN card.....	45
Installing the WWAN card.....	45
Coin-cell battery.....	46
Removing the coin-cell battery.....	46
Installing the coin-cell battery.....	47
Speakers.....	48
Removing the speakers.....	48
Installing the speakers.....	49
M.2 solid state drive.....	51
Removing the M.2 2230 solid-state drive.....	51
Installing the M.2 2230 solid-state drive.....	52
Chapter 6: Removing and installing Field Replaceable Units (FRUs).....	53
Battery.....	53
Rechargeable Li-ion battery precautions.....	53
Removing the battery.....	53
Installing the battery.....	55
Battery cable.....	55
Removing the battery cable.....	55
Installing the battery cable.....	56
Power-adaptor port.....	57
Removing the power-adaptor port.....	57
Installing the power-adaptor port.....	58
Heat sink.....	59
Removing the heat-sink for integrated graphics.....	59
Installing the heat-sink for integrated graphics.....	60
Removing the heat-sink for discrete graphics.....	61
Installing the heat-sink for discrete graphics.....	62
Fan.....	63
Removing the fan.....	63

Installing the fan.....	64
Touchpad.....	65
Removing the touchpad.....	65
Installing the touchpad.....	67
I/O board.....	68
Removing the I/O board.....	68
Installing the I/O board.....	69
Power-button board.....	71
Removing the power button.....	71
Installing the power button.....	71
System board.....	72
Removing the system board.....	72
Installing the system board.....	75
Palm-rest and keyboard assembly.....	77
Removing the palm-rest and keyboard assembly.....	77
Installing the palm-rest and keyboard assembly	78
Display assembly.....	80
Removing the display assembly.....	80
Installing the display assembly.....	82
Display bezel.....	84
Removing the display bezel.....	84
Installing the display bezel.....	85
Display panel.....	86
Removing the display panel.....	86
Installing the display panel.....	89
Camera.....	94
Removing the camera.....	94
Installing the camera.....	95
eDP cable.....	96
Removing the eDP cable.....	96
Installing the eDP cable.....	97
Display back cover.....	98
Removing the display back cover.....	98
Installing the display back cover.....	98
Chapter 7: Software.....	100
Operating system.....	100
Drivers and downloads.....	100
Chapter 8: BIOS Setup.....	101
Entering BIOS setup program.....	101
Navigation keys.....	101
F12 One Time Boot menu.....	101
View Advanced Setup options.....	102
View Service options.....	102
System setup options.....	102
Updating the BIOS.....	118
Updating the BIOS in Windows.....	118
Updating the BIOS in Ubuntu.....	118

Updating the BIOS using the USB drive in Windows.....	118
Updating the BIOS from the F12 One-Time boot menu.....	119
System and setup password.....	120
Assigning a System Setup password.....	120
Deleting or changing an existing system setup password.....	120
Clearing CMOS settings.....	121
Clearing BIOS (System Setup) and System passwords.....	121
Chapter 9: Troubleshooting.....	122
Handling swollen rechargeable Li-ion batteries.....	122
Locate the Service Tag or Express Service Code of your Dell computer	122
Dell SupportAssist Pre-boot System Performance Check diagnostics.....	123
Running the SupportAssist Pre-Boot System Performance Check.....	123
Built-in self-test (BIST).....	123
M-BIST.....	123
LCD Power rail test (L-BIST).....	124
LCD Built-in Self-Test (BIST).....	124
System-diagnostic lights.....	125
Recovering the operating system.....	125
Real-Time Clock (RTC Reset).....	126
Backup media and recovery options.....	126
Wi-Fi power cycle.....	126
Drain residual flea power (perform hard reset).....	126
Chapter 10: Getting help and contacting Dell.....	128

Set up your Latitude 3550

About this task

NOTE: The images in this document may differ from your computer depending on the configuration you ordered.

Steps

1. Connect the power adapter and press the power button.



Figure 1. Connect the power adapter and press the power button.

NOTE: The battery may go into power-saving mode during shipment to conserve charge on the battery. Ensure that the power adapter is connected to your computer when it is turned on for the first time.

2. Finish the operating system setup.

For Ubuntu:

Follow the on-screen instructions to complete the setup. For more information about installing and configuring Ubuntu, search in the Knowledge Base Resource at www.dell.com/support.





For Windows:

Follow the on-screen instructions to complete the setup. When setting up, Dell Technologies recommends that you:

- Connect to a network for Windows updates.
 - NOTE:** If connecting to a secured wireless network, enter the password for the wireless network access when prompted.
- If connected to the Internet, sign in with or create a Microsoft account. If not connected to the Internet, create an offline account.
- On the **Support and Protection** screen, enter your contact details.

3. Locate and use Dell apps from the Windows Start menu—Recommended.

Table 1. Locate Dell apps

Resources	Description
	<p>Dell Product Registration</p> <p>Register your computer with Dell.</p>
	<p>Dell Help & Support</p> <p>Access help and support for your computer.</p>
	<p>SupportAssist</p> <p>SupportAssist is the smart technology that keeps your computer running at its best by optimizing settings, detecting issues, removing viruses and notifies when you must make computer updates. SupportAssist proactively checks the health of your computer hardware and software. When an issue is detected, the necessary system state information is sent to Dell to begin troubleshooting. SupportAssist is preinstalled on most of the Dell devices running Windows operating system. For more information, see <i>SupportAssist for Business PCs manuals</i> at www.dell.com/support/home/product-support/product/supportassist-business-pcs/docs.</p> <p>NOTE: In SupportAssist, click the warranty expiry date to renew or upgrade your warranty.</p>
	<p>Dell Update</p> <p>Updates your computer with critical fixes and latest device drivers as they become available. For more information about using Dell Update, see the product guides and third-party license documents at www.dell.com/support.</p>
	<p>Dell Digital Delivery</p> <p>Download software applications, which are purchased but not preinstalled on your computer. For more information about using Dell Digital Delivery, search in the Knowledge Base Resource at www.dell.com/support.</p>

Views of Latitude 3550

Right



Figure 2. Right view

1. SIM-card slot (optional)

Insert a SIM card to connect to a mobile broadband network.

2. USB 3.2 Gen 1 port

Connect to external storage devices. Provides data transfer speeds up to 5 Gbps.

NOTE: This port does not support video/audio streaming.

3. RJ45 Ethernet port

Connect an Ethernet (RJ45) cable from a router or a broadband modem for network or Internet access, with a transfer rate of 10/100/1000 Mbps.

4. Ethernet status LED

Connect an Ethernet (RJ45) cable from a router or a broadband modem for network or Internet access.

One light next to the connector indicate the connectivity status and network activity.

5. Security-cable slot

Connect a security cable to prevent unauthorized movement of your computer.

Left

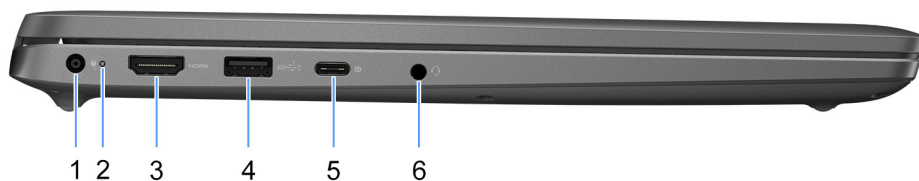

Figure 3. Left view

1. Power-adaptor port

Connect a power adapter to provide power to your computer.

2. Battery-status light

Indicates the battery-charge status.

Solid white—Power adapter is connected and the battery has more than 5% charge.

Amber—Computer is running on battery and the battery has less than 5% charge.

Off—Power adapter is disconnected or the battery is fully charged.

3. HDMI port

Connect to a TV, external display or another HDMI-in enabled device. Provides key video and audio output.

4. USB 3.2 Gen 1 port with PowerShare

Connect devices such as external storage devices and printers.

Provides data transfer speeds up to 5 Gbps. PowerShare enables you to charge your USB devices even when your computer is turned off.

NOTE: If your computer is turned off or in hibernate state, you must connect the power adapter to charge your devices using the PowerShare port. You must enable this feature in the BIOS setup program.

NOTE: Certain USB devices may not charge when the computer is turned off or in sleep state. In such cases, turn on the computer to charge the device.

5. USB4 Type-C 20Gbps port

Connect devices, such as external storage devices and printers. Provides data transfer rates of up to 20 Gbps.

NOTE: USB4 is backward compatible with USB 3.2 and USB 2.0.

6. Universal audio port

Connect audio-output devices such as speakers, amplifiers, and so on.

Top



Figure 4. Image: Top view

1. Power button with optional fingerprint reader

Press to turn on the computer if it is turned off, in sleep state, or in hibernate state.

When the computer is turned on, press the power button to put the computer into sleep state; press and hold the power button for 10 seconds to force shut-down the computer.

If the power button has a fingerprint reader, place your finger on the power button steadily to log in.

NOTE: The power-status light on the power button is available only on computers without the fingerprint reader. Computers that are shipped with the fingerprint reader that is integrated on the power button will not have the power-status light on the power button.

NOTE: You can customize the power-button behavior in Windows.

2. Touchpad

Move your finger on the touchpad to move the mouse pointer. Tap to left-click and two fingers tap to right-click.

Front

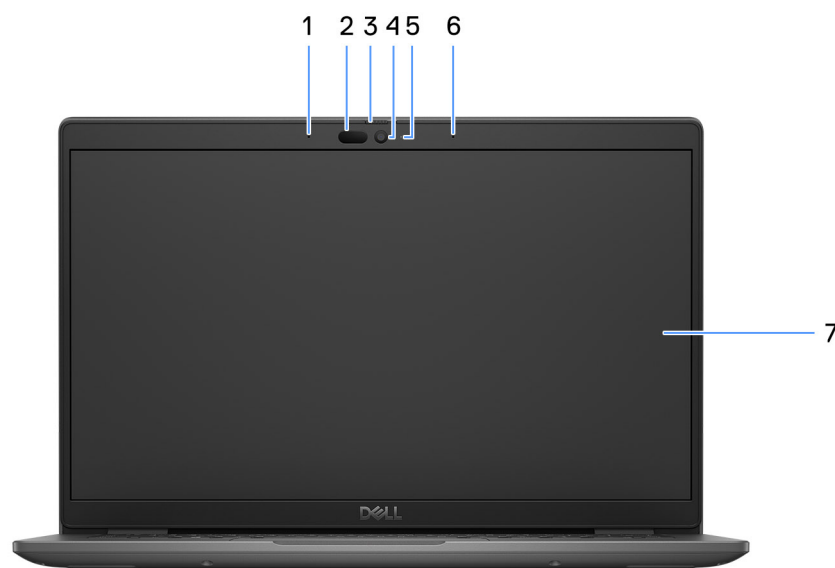

Figure 5. Image: Front view

1. Left microphone

Provides digital sound input for audio recording and voice calls.

2. Infrared camera (optional)

Enhances security when paired with Windows Hello face authentication.

3. Camera shutter

Slide the privacy shutter to the left to access the camera lens.

4. Camera

Enables you to video chat, capture photos, and record videos.

5. Camera-status light

Turns on when the camera is in use.

6. Right microphone

Provides digital sound input for audio recording and voice calls.

7. LCD panel

Provides visual output to the user.

Bottom

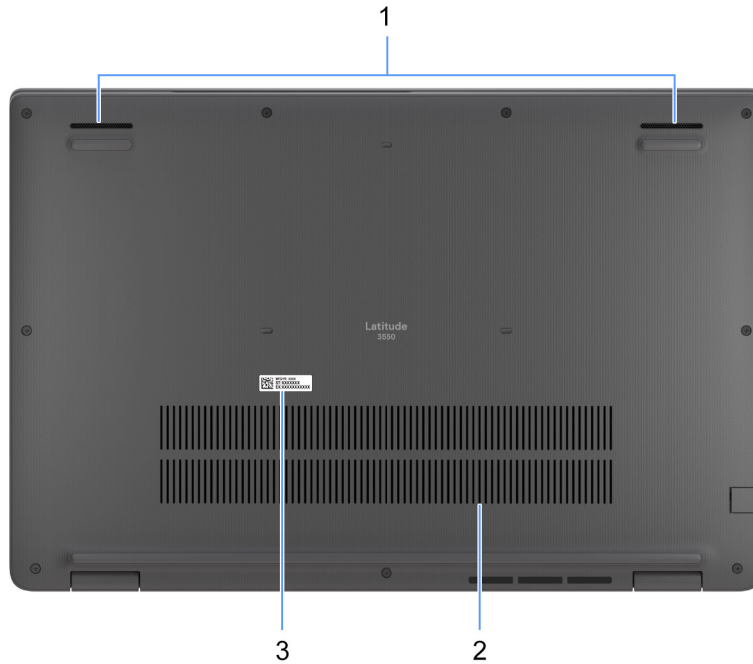

Figure 6. Image: Bottom view

1. Speakers

Provide audio output.

2. Air vents

Air vents provide ventilation for your computer. Clogged air vents can cause overheating and can affect your computer's performance and potentially cause hardware issues. Keep the air vents clear of obstructions and clean them regularly to prevent build-up of dust and dirt. For more information about cleaning air vents, search for articles in Knowledge Base Resource at www.dell.com/support.

3. Service Tag label

The Service Tag is a unique alphanumeric identifier that enables Dell service technicians to identify the hardware components in your computer and access warranty information.

Service Tag

The service tag is a unique alphanumeric identifier that allows Dell service technicians to identify the hardware components in your computer and access warranty information.

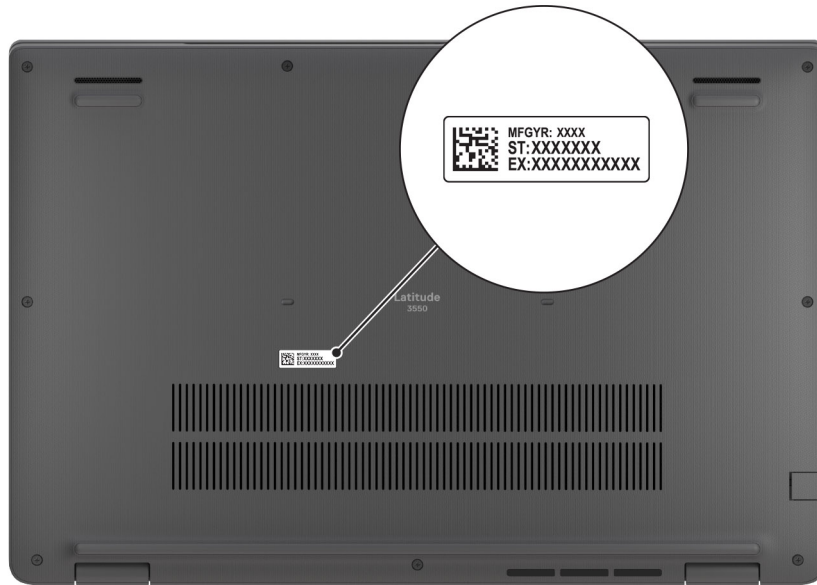

Figure 7. Image: Service Tag location

Battery charge and status light

The following table lists the battery charge and status light behavior of your Latitude 3550.

Table 2. Battery charge and status light behavior

Power source	LED behavior	System power state	Battery charge level
AC Adapter	Off	S0 - S5	Fully Charged
AC Adapter	Solid White	S0 - S5	< Fully Charged
Battery	Off	S0 - S5	11-100%
Battery	Solid Amber (590+/-3 nm)	S0 - S5	< 10%

- S0 (ON) - Computer is turned on.
- S4 (Hibernate) - The computer consumes the least power compared to all other sleep states. The computer is almost at an OFF state, expect for a trickle power. The context data is written to hard drive.
- S5 (OFF) - The computer is in a shutdown state.

Specifications of Latitude 3550

Dimensions and weight

The following table lists the height, width, depth, and weight of your Latitude 3550.

Table 3. Dimensions and weight

Description	Values
Height:	
Front height	18.13 mm (0.71 in.)
Rear height	20.40 mm(0.80 in.)
Width	359.00 mm (14.13 in.)
Depth	239.69 mm (9.43 in.)
Weight  NOTE: The weight of your computer depends on the configuration that is ordered and manufacturing variability.	Minimum—1.81 kg (3.99 lbs)

Processor

The following table lists the details of the processors that are supported for your Latitude 3550 .

Table 4. Processor

Description	Option one	Option two	Option three	Option four	Option five	Option six	Option seven
Processor type	13 th Generation Intel Core i3-1315U	13 th Generation Intel Core i5-1335U	13 th Generation Intel Core i5-1345U	13 th Generation Intel Core i7-1355U	Intel Core Ultra 5 125U	Intel Core Ultra 5 135U	Intel Core Ultra 7 155U
Processor wattage	15 W	15 W	15 W	15 W	15 W	15 W	15 W
Processor core count	6	10	10	10	12	12	12
Processor thread count	8	12	12	12	14	14	14
Processor speed	Up to 4.50 GHz	Up to 4.60 GHz	Up to 4.70 GHz	Up to 5.00 GHz	Up to 4.30 GHz	Up to 4.40 GHz	Up to 4.80 GHz
Processor cache	10 MB	12 MB	12 MB	12 MB	12 MB	12 MB	12 MB
Integrated graphics	Intel UHD Graphics	Intel Iris X ^e Graphics	Intel Iris X ^e Graphics	Intel Iris X ^e Graphics	Intel Integrated Graphics	Intel Integrated Graphics	Intel Integrated Graphics

Chipset

The following table lists the details of the chipset that is supported for your Latitude 3550.

Table 5. Chipset

Description	Option one	Option two
Processors	13 th Generation Intel Core i3/i5/i7	Intel Core Ultra 5/Ultra 7
Chipset	Intel RPL-U (integrated with the processor)	Intel MTL-U (integrated with the processor)
DRAM bus width	64-bit	64-bit
Flash EPROM	32 MB	32 MB+ 16 MB
PCIe bus	Up to Gen4	Up to Gen4

Operating system

Your Latitude 3550 supports the following operating systems:

- Windows 11 Pro
- Windows 11 Home
- Ubuntu 22.04 LTS, 64-bit

Memory

The following table lists the memory specifications of your Latitude 3550.

Table 6. Memory specifications

Description	Values
Memory slots	Two
Memory type	DDR5, single-channel, dual-channel
Memory speed	<ul style="list-style-type: none"> • For computers shipped with 13th Gen Intel Core i3/i5/i7 processors: 5200 MT/s • For computers shipped with Intel Core Ultra i5/i7 processors: 5600 MT/s
Maximum memory configuration	64 GB
Minimum memory configuration	8 GB
Memory size per slot	8 GB, 16 GB, 32 GB
Memory configurations supported	<p>For computers shipped with 13th Gen Intel Core i3/i5/i7 processor:</p> <ul style="list-style-type: none"> • 8 GB: 1 x 8 GB, DDR5, 5200 MT/s, single-channel • 16 GB: 2 x 8 GB, DDR5, 5200 MT/s, dual-channel • 16 GB: 1 x 16 GB, DDR5, 5200 MT/s, single-channel • 32 GB: 2 x 16 GB, DDR5, 5200 MT/s, dual-channel • 64 GB: 2 x 32 GB, DDR5, 5200 MT/s, dual-channel <p>For computers shipped with Intel Core Ultra i5/i7 processor:</p>

Table 6. Memory specifications (continued)

Description	Values
	<ul style="list-style-type: none"> • 8 GB: 1 x 8 GB, DDR5, 5600 MT/s, single-channel • 16 GB: 2 x 8 GB, DDR5, 5600 MT/s, dual-channel • 16 GB: 1 x 16 GB, DDR5, 5600 MT/s, single-channel • 32 GB: 2 x 16 GB, DDR5, 5600 MT/s, dual-channel • 64 GB: 2 x 32 GB, DDR5, 5600 MT/s, dual-channel

External ports

The following table lists the external ports of your Latitude 3550.

Table 7. External ports

Description	Values
Network port	One Flip-down RJ 45 10/100/1000 Mbps
USB ports	<ul style="list-style-type: none"> • One USB4 (20 Gbps) with Power Delivery and DisplayPort • One USB 3.2 Gen 1 port with PowerShare • Two USB 3.2 Gen 1 port
Audio port	One universal audio port
Video port	<ul style="list-style-type: none"> • One HDMI 1.4 port (for computers shipped with 13th Gen Intel Core i3/i5/i7 processor) • One HDMI 2.0 port (for computers shipped with Intel Core Ultra i5/i7 processor)
SIM card slot	One micro-SIM card slot
Power-adaptor port	One DC-in port (4.5 mm standard plug/USB-C port)
Security-cable slot	One wedge-shaped lock slot

Internal slots

The following table lists the internal slots of your Latitude 3550.

Table 8. Internal slots

Description	Values
M.2	<ul style="list-style-type: none"> • One M.2 2230 for solid-state drive • One M.2 2230 slot for WLAN card, Wi-Fi/Bluetooth • One M.2 3042 slot for WWAN card, Wi-Fi/Bluetooth <p> NOTE: To learn more about the features of different types of M.2 cards, search in the Knowledge Base Resource at www.dell.com/support.</p>

Ethernet

The following table lists the wired Ethernet Local Area Network (LAN) specifications of your Latitude 3550.

Table 9. Ethernet specifications

Description	Values
Model number	RTL8111H-CG
Transfer rate	10/100/1000 Mbps

Wireless module

The following table lists the Wireless Local Area Network (WLAN) modules that are supported on your Latitude 3550.

Table 10. Wireless module specifications

Description	Option one	Option two
Model number	Intel AX211	Realtek RTL8852BE
Transfer rate	Up to 2400 Mbps	Up to 1200 Mbps
Frequency bands supported	2.4 GHz/5 GHz/6 GHz	2.4 GHz/5 GHz
Wireless standards	<ul style="list-style-type: none">• WiFi 802.11a/b/g• Wi-Fi 4 (WiFi 802.11n)• Wi-Fi 5 (WiFi 802.11ac)• Wi-Fi 6E (WiFi 802.11ax)• Wi-Fi 6 (WiFi 802.11ax)	<ul style="list-style-type: none">• WiFi 802.11a/b/g• Wi-Fi 4 (WiFi 802.11n)• Wi-Fi 5 (WiFi 802.11ac)• Wi-Fi 6 (WiFi 802.11ax)
Encryption	<ul style="list-style-type: none">• 64-bit/128-bit WEP• AES-CCMP• TKIP	<ul style="list-style-type: none">• 64-bit/128-bit WEP• AES-CCMP• TKIP
Bluetooth wireless card	Bluetooth 5.3	Bluetooth 5.3
	 NOTE: The version of the Bluetooth wireless card may vary depending on the operating system that is installed on your computer.	

WWAN module

The following table lists the Wireless Wide Area Network (WWAN) module supported on your Latitude 3550.

Table 11. WWAN module specifications

Description	Values
Model number	Qualcomm Snapdragon SDX12 Global LTE-Advanced (DW5825e)
Form factor	M.2 3042 KEY-B
Host interface	USB 3.0/2.0

Table 11. WWAN module specifications (continued)

Description	Values
Network standard	<ul style="list-style-type: none"> • LTE FDD/TDD, WCDMA/HSPA+ • GPS/GLONASS/Galileo
Transfer rate	<ul style="list-style-type: none"> • Downlink: • LTE FDD: 1 Gbps (Cat12) • LTE TDD: 600 Mbps (Cat 12) • UMTS: 384 Kbps • DC-HSPA+: 42 Mbps (Cat12) • Uplink: • LTE FDD: 150 Mbps (Cat12) • LTE TDD: 150 Mbps (Cat12) • UMTS: 384 Kbps • DC-HSPA+: 5.76 Mbps (Cat12)
Operating frequency bands	<ul style="list-style-type: none"> • LTE FDD (B1, B2, B3, B4, B5, B7, B8, B12, B13, B14, B17, B18, B19, B20, B25, B26, B28, B29, B30, B32, B66, B71) • LTE TDD (B34, B38, B39, B40, B41, B42, B43, B48) • WCDMA (B1, B2, B4, B5, B8)
Power supply	DC 3.135 V to 4.4 V, Typical 3.3 V
SIM card	Supported through external or internal SIM-card slot
eSIM with Dual SIM (DSSA)	Supported (The availability of eSIM functionality embedded on the module is dependent on the region and specific carrier requirements)
Antenna Diversity	Supported
Radio On/Off	Supported
Wake On Wireless	Supported
Temperature	<ul style="list-style-type: none"> • Normal operating temperature: -10 °C to +55 °C • Extended operating temperature: -30 °C to +75 °C • Storage Temperature: -40 °C to +85 °C
Antenna connector	<ul style="list-style-type: none"> • WWAN Main Antenna x 1 • WWAN Diversity Antenna x 1
 NOTE: For instructions on how to find your computer's IMEI (International Mobile Station Equipment Identity) number, search in the Knowledge Base Resource at www.dell.com/support .	

Audio

The following table lists the audio specifications of your Latitude 3550.

Table 12. Audio specifications

Description	Values
Audio controller	Realtek ALC3204
Stereo conversion	Supported with Waves MaxxAudio Pro
Internal audio interface	High definition audio interface

Table 12. Audio specifications (continued)

Description		Values
External audio interface		One universal audio port
Number of speakers		Two
Internal-speaker amplifier		Supported (audio codec integrated)
External volume controls		Supported
Speaker output:		
	Average speaker output	2 W x 2 = 4 W
	Peak speaker output	2.5 W x 2 = 5 W
Subwoofer output		Not supported
Microphone		Digital-array microphone

Storage

This section lists the storage options on your Latitude 3550.

One M.2 2230 solid-state drive

Table 13. Storage specifications

Storage type	Interface type	Capacity
M.2 2230 Class 25 QLC SSD	PCIe NVMe Gen4	Up to 1 TB
M.2 2230 Class 35 TLC SSD	PCIe NVMe Gen4	Up to 1 TB

Keyboard

The following table lists the keyboard specifications of your Latitude 3550.

Table 14. Keyboard specifications

Description	Values
Keyboard type	<ul style="list-style-type: none"> Standard AI hotkey backlit keyboard without fingerprint reader Standard AI hotkey backlit keyboard with fingerprint reader Standard AI hotkey non-backlit keyboard without fingerprint reader Standard AI hotkey non-backlit keyboard with fingerprint reader <p>NOTE:</p> <ul style="list-style-type: none"> All keyboards are spill-resistant. Copilot in Windows is available only in approved markets.
Keyboard layout	QWERTY

Table 14. Keyboard specifications (continued)

Description	Values
Number of keys	<ul style="list-style-type: none"> ● United States and Canada: 99 keys ● United Kingdom: 100 keys ● Japan: 103 keys ● Brazil and Quebec: 101 keys
Keyboard size	X=18.05 mm key pitch Y=18.05 mm key pitch
Keyboard shortcuts	<p>Some keys on your keyboard have two symbols on them. These keys can be used to type alternate characters or to perform secondary functions. To type the alternate character, press Shift and the desired key. To perform secondary functions, press Fn and the desired key.</p> <p>i NOTE: You can define the primary behavior of the function keys (F1–F12) changing Function Key Behavior in BIOS setup program.</p> <p>i NOTE: If Copilot in Windows is not available on your computer, the Copilot key launches Windows Search. For more information about Copilot in Windows, search in the Knowledge Base Resource at www.dell.com/support.</p>

Keyboard shortcuts of Latitude 3550

i **NOTE:** Keyboard characters may differ depending on the keyboard language configuration. Keys used for shortcuts remain the same across all language configurations.

Some keys on your keyboard have two symbols on them. These keys can be used to type alternate characters or to perform secondary functions. The symbol shown on the lower part of the key refers to the character that is typed out when the key is pressed. If you press shift and the key, the symbol shown on the upper part of the key is typed out. For example, if you press **2**, **2** is typed out; if you press **Shift + 2**, **@** is typed out.

The keys F1-F12 at the top row of the keyboard are function keys for multi-media control, as indicated by the icon at the bottom of the key. Press the function key to invoke the task represented by the icon. For example, pressing F1 mutes the audio (refer to the table below).

However, if the function keys F1-F12 are needed for specific software applications, multi-media functionality can be disabled by pressing **Fn + Esc**. Subsequently, multi-media control can be invoked by pressing **Fn** and the respective function key. For example, mute audio by pressing **Fn + F1**.

i **NOTE:** You can also define the primary behavior of the function keys (F1–F12) by changing **Function Key Behavior** in BIOS setup program.

Table 15. List of keyboard shortcuts

Function key	Primary behavior
F1	Mute audio
F2	Decrease volume
F3	Increase volume
F4	Mute mic
F5	Click keyboard backlight (optional). i NOTE: Non-backlight keyboards have F5 function key without the backlight icon and do not support toggle keyboard backlight function.

Table 15. List of keyboard shortcuts (continued)

Function key	Primary behavior
	 NOTE: Toggle to cycle the keyboard backlight status through off, low-backlight, and high-backlight
F6	Decrease brightness
F7	Increase brightness
F8	Switch to external display
F10	Print screen
F11	Home
F12	End

The **Fn** key is also used with selected keys on the keyboard to invoke other secondary functions.

Table 16. Secondary behavior

Function key	Secondary behavior
Fn + F1	Operating system and application specific F1 behavior
Fn + F2	Operating system and application specific F2 behavior
Fn + F3	Operating system and application specific F3 behavior
Fn + F4	Operating system and application specific F4 behavior
Fn + F5	Operating system and application specific F5 behavior
Fn + F6	Operating system and application specific F6 behavior
Fn + F7	Operating system and application specific F7 behavior
Fn + F8	Operating system and application specific F8 behavior
Fn + F10	Operating system and application specific F10 behavior
Fn + F11	Operating system and application specific F11 behavior
Fn + F12	Operating system and application specific F12 behavior
Fn + PrtScr	Turn off/on wireless
Fn + B	Pause
Fn + Ctrl + B	Break
Fn + Insert	Sleep
Fn + S	Toggle scroll lock
Fn + H	Toggle between power and battery-status light/hard-drive activity light
Fn + R	System request
Fn + Ctrl	Open application menu
Fn + Esc	Toggle Fn-key lock
Fn + PgUp	Page up
Fn + PgDn	Page down
Fn + Home	Home
Fn + End	End
Fn + Right Ctrl	Shortcut/Secondary menu assigned to right Ctrl key

Table 16. Secondary behavior (continued)

Function key	Secondary behavior
Fn + Shift + B	Calls unobtrusive mode NOTE:  The key sequence will call unobtrusive mode. The hotkey sequence will be disabled by default to prevent accidental actuation. You may enable through BIOS setup option.

Camera

The following table lists the camera specifications of your Latitude 3550.

Table 17. Camera specifications

Description	Values
Number of cameras	Two
Camera type	<ul style="list-style-type: none"> • HD RGB • FHD RGB • FHD RGB + IR
Camera location	Front camera
Camera sensor type	CMOS sensor technology
Camera resolution:	
Still image	<ul style="list-style-type: none"> • 0.92 megapixels (HD) • 2.07 megapixels (FHD)
Video	<ul style="list-style-type: none"> • 1280 x 720 (HD) at 30 fps • 1920 x 1080 (FHD) at 30 fps
Infrared camera resolution:	
Still image	0.23 megapixel
Video	640 x 360 at 15 fps
Diagonal viewing angle:	
Camera	<ul style="list-style-type: none"> • 78.60 degrees (HD) • 80.20 degrees (FHD)
Infrared camera	86.60 degrees

Touchpad

The following table lists the touchpad specifications of your Latitude 3550.

Table 18. Touchpad specifications

Description	Values
Touchpad resolution:	>300 dpi
Touchpad dimensions:	

Table 18. Touchpad specifications (continued)

Description		Values
	Horizontal	115 mm (4.52 in.)
	Vertical	67 mm (2.63 in.)
Touchpad gestures		For more information about touchpad gestures available on Windows, see the Microsoft Knowledge Base article at support.microsoft.com .

Power adapter

The following table lists the power adapter specifications of your Latitude 3550.

Table 19. Power adapter specifications

Description	Option one	Option two	Option three	Option four
Type	60W AC adapter, small form factor, USB Type-C, 2-pin (Japan)	65W AC adapter, 4.5 mm barrel, E4	65W AC adapter, USB Type-C, EcoDesign	100W AC adapter, USB Type-C, E5
Connector dimensions:				
External diameter	N/A	4.50 mm	N/A	N/A
Internal diameter	N/A	2.90 mm	N/A	N/A
Input voltage	100 VAC to 240 VAC	100 VAC - 240 VAC	100 VAC - 240 VAC	100 VAC - 240 VAC
Input frequency	50 Hz to 60 Hz	50 Hz - 60 Hz	50 Hz - 60 Hz	50 Hz - 60 Hz
Input current (maximum)	1.70 A	1.60 A/1.70 A	1.70 A	1.70 A
Output current (continuous)	<ul style="list-style-type: none"> • 20 V/3 A • 15 V/3 A • 9 V/3 A • 5 V/3 A 	3.34 A	<ul style="list-style-type: none"> • 20 V/3.25 A (continuous) • 15 V/3 A (continuous) • 9.0 V/3 A (continuous) • 5.0 V/3 A (continuous) 	<ul style="list-style-type: none"> • 20 V/5 A (continuous) • 15 V/3 A (continuous) • 9.0 V/3 A (continuous) • 5.0 V/3 A (continuous)
Rated output voltage	<ul style="list-style-type: none"> • 20 VDC • 15 VDC • 9 VDC • 5 VDC 	19.50 VDC	<ul style="list-style-type: none"> • 20 VDC • 15 VDC • 9 VDC • 5 VDC 	<ul style="list-style-type: none"> • 20 VDC • 15 VDC • 9 VDC • 5 VDC
Temperature range:				
Operating	0°C to 40°C (32°F to 104°F)	0°C to 40°C (32°F to 104°F)	0°C to 40°C (32°F to 104°F)	0°C to 40°C (32°F to 104°F)
Storage	-40°C to 70°C (-40°F to 158°F)	-40°C to 70°C (-40°F to 158°F)	-40°C to 70°C (-40°F to 158°F)	-40°C to 70°C (-40°F to 158°F)

Battery

The following table lists the battery specifications of your Latitude 3550.

Table 20. Battery specifications

Description	Option one	Option two	Option three	Option four	
Battery type	3-cell, 42 Wh, ExpressCharge, ExpressCharge Boost Capable	3-cell, 54 Wh, ExpressCharge, ExpressCharge Boost Capable	3-cell, 42 Wh, ExpressCharge, Long Life Cycle, 3-year limited hardware warranty	3-cell, 54 Wh, ExpressCharge, Long Life Cycle, 3-year limited hardware warranty	
Battery voltage	11.4 VDC	11.4 VDC	11.4 VDC	11.4 VDC	
Battery weight (maximum)	0.19 kg	0.22 kg	0.19 kg	0.22 kg	
Battery dimensions:					
	Height	5.73 mm (0.22 in.)	5.73 mm (0.22 in.)	5.73 mm (0.22 in.)	5.73 mm (0.22 in.)
	Width	263 mm (10.35 in.)	263 mm (10.35 in.)	263 mm (10.35 in.)	263 mm (10.35 in.)
	Depth	79.42 mm (3.12 in.)	79.42 mm (3.12 in.)	79.42 mm (3.12 in.)	79.42 mm (3.12 in.)
Temperature range:					
	Operating	0°C to 45°C (32°F to 113°F)	0°C to 45°C (32°F to 113°F)	0°C to 45°C (32°F to 113°F)	0°C to 45°C (32°F to 113°F)
	Storage	-20°C to 60°C (-4°F to 140°F)	-20°C to 60°C (-4°F to 140°F)	-20°C to 60°C (-4°F to 140°F)	-20°C to 60°C (-4°F to 140°F)
Battery operating time	Varies depending on operating conditions and can significantly reduce under certain power-intensive conditions.		Varies depending on operating conditions and can significantly reduce under certain power-intensive conditions.		
Battery charging time (approximate)	<ul style="list-style-type: none"> 0~15°C—4 hours (when the computer is off) 16~45°C—2 hours (when the computer is off) 46~50°C—3 hours (when the computer is off) 		<ul style="list-style-type: none"> 0~15°C—4 hours (when the computer is off) 16~45°C—2 hours (when the computer is off) 46~50°C—3 hours (when the computer is off) 		
	<p>NOTE: Control the charging time, duration, start and end time, and so on using the Dell Power Manager application. For more information on the Dell Power Manager see, <i>Me and My Dell</i> on www.dell.com.</p>				
Coin-cell battery	CR2032	CR2032	CR2032	CR2032	

CAUTION: Operating and storage temperature ranges may differ among components, so operating or storing the device outside these ranges may impact the performance of specific components.

Table 20. Battery specifications (continued)

Description	Option one	Option two	Option three	Option four
 CAUTION: Dell recommends that you charge the battery regularly for optimal power consumption. If your battery charge is completely depleted, connect the power adapter, turn on your computer, and then restart your computer to reduce the power consumption.				

Display

The following table lists the display specifications of your Latitude 3550.

Table 21. Display specifications

Description	Option one	Option two	Option three
Display type	15.6-inch, High Definition (HD)	15.6-inch, Full High Definition (FHD)	15.6-inch, Full High Definition (FHD)
Touch options	No	No	Yes
Color	262,144	262,144	262,144
Panel type	6 bit	6 bit	6 bit
Display-panel technology	Twisted nematic	In Plane Switching (IPS)	In Plane Switching (IPS)
Display-panel dimensions (active area):			
	Height	344.16 mm (13.55 in.)	344.16 mm (13.55 in.)
	Width	193.59 mm (7.62 in.)	193.59 mm (7.62 in.)
	Diagonal	394.87 mm (15.54 in.)	394.87 mm (15.54 in.)
Display-panel native resolution	1366 x 768	1920 x 1080	1920 x 1080
Luminance (typical)	220 nits	250 nits	250 nits
Megapixels	1.05	2.07	2.07
Color gamut	45% (NTSC)	45% (NTSC)	45% (NTSC)
Pixels Per Inch (PPI)	100	141	141
Contrast ratio (typical)	500:1	700:1	700:1
Response time (max)	25 ms	35 ms	35 ms
Refresh rate	60 Hz	60 Hz	60 Hz
Horizontal view angle	45 +/- degrees	85 +/- degrees	85 +/- degrees
Vertical view angle	35 +/- degrees	85 +/- degrees	85 +/- degrees
Pixel pitch	0.252 (H)*0.252 (V)	0.17925 (H)*0.17925 (V)	0.17925 (H)*0.17925 (V)
Power consumption (maximum)	4.2 W	4.6 W	4.7 W

Table 21. Display specifications (continued)

Description	Option one	Option two	Option three
Anti-glare vs glossy finish	Anti-glare	Anti-glare	Anti-glare

Fingerprint reader

The following table lists the fingerprint-reader specifications of your Latitude 3550.

NOTE: The fingerprint reader is on the power button.

Table 22. Fingerprint reader specifications

Description	Values
Fingerprint-reader sensor technology	Capacitive
Fingerprint-reader sensor resolution	500 ppi
Fingerprint-reader sensor pixel size	108 x 88

Sensor

The following table lists the sensor of your Latitude 3550.

Table 23. Sensor

Sensor support
Adaptive Thermal Performance-Applicable only for discrete graphics

GPU—Integrated

The following table lists the specifications of the integrated Graphics Processing Unit (GPU) supported by your Latitude 3550.

Table 24. GPU—Integrated

Controller	External display support	Memory size	Processor
Intel UHD Graphics	<ul style="list-style-type: none"> One USB4 (20 Gbps) with Power Delivery and DisplayPort One HDMI 1.4 port TBT backward compatible 	Shared system memory	13 th Generation Intel Core i3-1315U
Intel Iris Xe Graphics	<ul style="list-style-type: none"> One USB4 (20 Gbps) with Power Delivery and DisplayPort One HDMI 1.4 port TBT backward compatible 	Shared system memory	<ul style="list-style-type: none"> 13th Generation Intel Core i5-1335U 13th Generation Intel Core i5-1345U 13th Generation Intel Core i7-1355U
Intel Integrated Graphics	<ul style="list-style-type: none"> One USB4 (20 Gbps) with Power Delivery and DisplayPort One HDMI 2.0 port TBT backward compatible 	Shared system memory	<ul style="list-style-type: none"> Intel Core Ultra 5 125U Intel Core Ultra 5 135U Intel Core Ultra 7 155U

GPU—Discrete

The following table lists the specifications of the discrete Graphics Processing Unit (GPU) supported by your Latitude 3550.

Table 25. GPU—Discrete

Controller	Memory size	Memory type
Nvidia GeForce MX570A	2 GB	GDDR6

Multiple display support matrix

The following table lists the multiple display support matrix for your Latitude 3550.

Table 26. Multiple display support matrix

Graphics Card	Direct Graphics Controller Direct Output Mode	Supported external displays with computer internal display on	Supported external displays with computer internal display off
Intel UHD Graphics	Integrated	3	4
Intel Iris X ^e Graphics	Integrated	3	4
Intel Integrated Graphics	Integrated	3	4

Hardware security

The following table lists the hardware security of your Latitude 3550.

Table 27. Hardware security

Hardware security
One wedge-shaped lock slot
FIPS 140-2 certification for TPM
TCG Certification for TPM (Trusted Computing Group)
Chassis Intrusion Detection
BIOS - TPM clear and/or system boot lock after chassis intrusion detection
RPMC (specify via SPI Flash or eRPMC)
SPI Flash Tamper Detection / Prevention Shunt Circuit

Operating and storage environment

This table lists the operating and storage specifications of your Latitude 3550.

Airborne contaminant level: G1 as defined by ISA-S71.04-1985

Table 28. Computer environment

Description	Operating	Storage
Temperature range	0°C to 40°C (32°F to 104°F)	-40°C to 65°C (-40°F to 149°F)
Relative humidity (maximum)	90% (non-condensing)	95% (non-condensing)
Vibration (maximum)*	0.66 GRMS	NA
Shock (maximum)	140 G†	NA
Altitude range	-15.2 m to 3048 m (-49.8 ft to 10000 ft)	-15.2 m to 10668 m (-49.8 ft to 35000 ft)
 CAUTION: Operating and storage temperature ranges may differ among components, so operating or storing the device outside these ranges may impact the performance of specific components.		











* Measured using a random vibration spectrum that simulates the user environment.

† Measured using a 2 ms half-sine pulse.

Working inside your computer



Safety instructions

Use the following safety guidelines to protect your computer from potential damage and to ensure your personal safety. Unless otherwise noted, each procedure in this document assumes that you have read the safety information that shipped with your computer.

-  **WARNING:** Before working inside your computer, read the safety information that is shipped with your computer. For more safety best practices, see the Regulatory Compliance home page at www.dell.com/regulatory_compliance.
-  **WARNING:** Disconnect your computer from all power sources before opening the computer cover or panels. After you finish working inside the computer, replace all covers, panels, and screws before connecting your computer to an electrical outlet.
-  **CAUTION:** To avoid damaging the computer, ensure that the work surface is flat, dry, and clean.
-  **CAUTION:** To avoid damaging the components and cards, handle them by their edges, and avoid touching the pins and the contacts.
-  **CAUTION:** You should only perform troubleshooting and repairs as authorized or directed by the Dell technical assistance team. Damage due to servicing that is not authorized by Dell is not covered by your warranty. See the safety instructions that is shipped with the product or at www.dell.com/regulatory_compliance.
-  **CAUTION:** Before touching anything inside your computer, ground yourself by touching an unpainted metal surface, such as the metal at the back of the computer. While you work, periodically touch an unpainted metal surface to dissipate static electricity which could harm internal components.
-  **CAUTION:** When you disconnect a cable, pull it by its connector or its pull tab, not the cable itself. Some cables have connectors with locking tabs or thumbscrews that you must disengage before disconnecting the cable. When disconnecting cables, keep them evenly aligned to avoid bending the connector pins. When connecting cables, ensure that the ports and the connectors are correctly oriented and aligned.
-  **CAUTION:** Press and eject any installed card from the media-card reader.
-  **CAUTION:** Exercise caution when handling rechargeable Li-ion batteries in laptops. Swollen batteries should not be used and should be replaced and disposed properly.
-  **NOTE:** The color of your computer and certain components may differ from what is shown in this document.

Before working inside your computer

Steps

1. Save and close all open files and exit all open applications.
2. Shut down your computer. For Windows operating system, click **Start** >  **Power** > **Shut down**.
 -  **NOTE:** If you are using a different operating system, see the documentation of your operating system for shut-down instructions.
3. Disconnect your computer and all attached devices from their electrical outlets.
4. Disconnect all attached network devices and peripherals, such as keyboard, mouse, and monitor from your computer.

5. Remove any media card and optical disk from your computer, if applicable.
6. Enter the service mode, if you can turn on your computer.

Service Mode

Service Mode is used to cut off power, without disconnecting the battery cable from the system board prior to conducting repairs in the computer.

 **CAUTION:** If you are unable to turn on the computer to put it into Service Mode, or the computer does not support Service Mode, proceed to disconnect the battery cable. To disconnect the battery cable, follow the steps in [Removing the battery](#).

 **NOTE:** Ensure that your computer is shut down and the AC adapter is disconnected.

- a. Hold the **** key on the keyboard and press the power button for 3 seconds or until the Dell logo appears on the screen.
- b. Press any key to continue.
- c. If the AC adapter is not disconnected, a message prompting you to remove the AC adapter appears on the screen. Remove the AC adapter and then press any key to continue the **Service Mode** process. The **Service Mode** process automatically skips the following step if the **Owner Tag** of the computer is not set up in advance by the user.
- d. When the **ready-to-proceed** message appears on the screen, press any key to proceed. The computer emits three short beeps and shuts down immediately.
- e. Once the computer shuts down, it has successfully entered Service Mode.

 **NOTE:** If you are unable to turn on your computer or unable to enter Service Mode, skip this process.

Safety precautions

The safety precautions chapter details the primary steps to be taken before performing any disassembly instructions.

Observe the following safety precautions before you perform any installation or break-fix procedures involving disassembly or reassembly:

- Turn off the computer and all attached peripherals.
- Disconnect the computer and all attached peripherals from AC power.
- Disconnect all network cables, telephone, and telecommunications lines from the computer.
- Use an ESD field service kit when working inside any to avoid electrostatic discharge (ESD) damage.
- After removing any computer component, carefully place the removed component on an anti-static mat.
- Wear shoes with non-conductive rubber soles to reduce the chance of getting electrocuted.
- Unplugging, pressing, and holding the power button for 15 seconds should discharge residual power in the system board.

Standby power

Dell products with standby power must be unplugged before you open the case. Systems that incorporate standby power are powered while turned off. The internal power enables the computer to be remotely turned on (Wake-on-LAN) and suspended into a sleep mode and has other advanced power management features.

Bonding

Bonding is a method for connecting two or more grounding conductors to the same electrical potential. This is done by using a field service electrostatic discharge (ESD) kit. When connecting a bonding wire, ensure that it is connected to bare metal and never to a painted or nonmetal surface. The wrist strap should be secure and in full contact with your skin, and ensure that you remove all jewelry such as watches, bracelets, or rings prior to bonding yourself and the equipment.

Electrostatic discharge—ESD protection

ESD is a major concern when you handle electronic components, especially sensitive components such as expansion cards, processors, memory modules, and system boards. Slight charges can damage circuits in ways that may not be obvious, such as intermittent problems or a shortened product life span. As the industry pushes for lower power requirements and increased density, ESD protection is an increasing concern.

Due to the increased density of semiconductors used in recent Dell products, the sensitivity to static damage is now higher than in previous Dell products. For this reason, some previously approved methods of handling parts are no longer applicable.

Two recognized types of ESD damage are catastrophic and intermittent failures.

- **Catastrophic** – Catastrophic failures represent approximately 20 percent of ESD-related failures. The damage causes an immediate and complete loss of device functionality. An example of catastrophic failure is a memory DIMM that has received a static shock and immediately generates a "No POST/No Video" symptom with a beep code that is emitted for missing or nonfunctional memory.
- **Intermittent** – Intermittent failures represent approximately 80 percent of ESD-related failures. The high rate of intermittent failures means that most of the time when damage occurs, it is not immediately recognizable. The DIMM receives a static shock, but the tracing is merely weakened and does not immediately produce outward symptoms that are related to the damage. The weakened trace may take weeks or months to melt, and in the meantime may cause degradation of memory integrity, intermittent memory errors, and so on.

The more difficult type of damage to recognize and troubleshoot is the intermittent (also called latent or "walking wounded") failure.

Perform the following steps to prevent ESD damage:

- Use a wired ESD wrist strap that is properly grounded. Wireless anti-static straps do not provide adequate protection. Touching the chassis before handling parts does not ensure adequate ESD protection on parts with increased sensitivity to ESD damage.
- Handle all static-sensitive components in a static-safe area. If possible, use anti-static floor pads and workbench pads.
- When unpacking a static-sensitive component from its shipping carton, do not remove the component from the anti-static packing material until you are ready to install the component. Before unwrapping the anti-static packaging, ensure that you discharge static electricity from your body.
- Before transporting a static-sensitive component, place it in an anti-static container or packaging.

ESD Field Service kit

The unmonitored Field Service kit is the most commonly used service kit. Each Field Service kit includes three main components: anti-static mat, wrist strap, and bonding wire.

Components of an ESD field service kit

The components of an ESD field service kit are:

- **Anti-Static Mat** – The anti-static mat is dissipative and parts can be placed on it during service procedures. When using an anti-static mat, your wrist strap should be snug and the bonding wire should be connected to the mat and to any bare metal on the computer being worked on. Once deployed properly, service parts can be removed from the ESD bag and placed directly on the mat. ESD-sensitive items are safe in your hand, on the ESD mat, in the computer, or inside an ESD bag.
- **Wrist Strap and Bonding Wire** – The wrist strap and bonding wire can be either directly connected between your wrist and bare metal on the hardware if the ESD mat is not required, or connected to the anti-static mat to protect hardware that is temporarily placed on the mat. The physical connection of the wrist strap and bonding wire between your skin, the ESD mat, and the hardware is known as bonding. Use only Field Service kits with a wrist strap, mat, and bonding wire. Never use wireless wrist straps. Always be aware that the internal wires of a wrist strap are prone to damage from normal wear and tear, and must be checked regularly with a wrist strap tester in order to avoid accidental ESD hardware damage. It is recommended to test the wrist strap and bonding wire at least once per week.
- **ESD Wrist Strap Tester** – The wires inside an ESD strap are prone to damage over time. When using an unmonitored kit, it is a best practice to regularly test the strap prior to each service call, and at a minimum, test once per week. A wrist strap tester is the best method for doing this test. If you do not have your own wrist strap tester, check with your regional office to find out if they have one. To perform the test, plug the bonding-wire of wrist-strap into the tester while it is strapped to your wrist and push the button to test. A green LED is lit if the test is successful; a red LED is lit and an alarm sounds if the test fails.
- **Insulator Elements** – It is critical to keep ESD sensitive devices, such as plastic heat sink casings, away from internal parts that are insulators and often highly charged.
- **Working Environment** – Before deploying the ESD Field Service kit, assess the situation at the customer location. For example, deploying the kit for a server environment is different than for a desktop or laptop environment. Servers are typically installed in a rack within a data center; desktops or laptops are typically placed on office desks or cubicles. Always look for a large open flat work area that is free of clutter and large enough to deploy the ESD kit with additional space to accommodate the type of computer that is being repaired. The workspace should also be free of insulators that can cause an ESD event. On the work area, insulators such as Styrofoam and other plastics should always be moved at least 12 inches or 30 centimeters away from sensitive parts before physically handling any hardware components.

- **ESD Packaging** – All ESD-sensitive devices must be shipped and received in static-safe packaging. Metal, static-shielded bags are preferred. However, you should always return the damaged part using the same ESD bag and packaging that the new part arrived in. The ESD bag should be folded over and taped shut and all the same foam packing material should be used in the original box that the new part arrived in. ESD-sensitive devices should be removed from packaging only at an ESD-protected work surface, and parts should never be placed on top of the ESD bag because only the inside of the bag is shielded. Always place parts in your hand, on the ESD mat, in the computer, or inside an anti-static bag.
- **Transporting Sensitive Components** – When transporting ESD sensitive components such as replacement parts or parts to be returned to Dell, it is critical to place these parts in anti-static bags for safe transport.

ESD protection summary

It is recommended to always use the traditional wired ESD grounding wrist strap and protective anti-static mat when servicing Dell products. In addition, it is critical to keep sensitive parts separate from all insulator parts while performing service and use anti-static bags for transporting sensitive components.

Transporting sensitive components

When transporting ESD sensitive components such as replacement parts or parts to be returned to Dell, it is critical to place these parts in anti-static bags for safe transport.

After working inside your computer

About this task

 **CAUTION:** Leaving stray or loose screws inside your computer may severely damage your computer.

Steps

1. Replace all screws and ensure that no stray screws remain inside your computer.
2. Connect any external devices, peripherals, or cables you removed before working on your computer.
3. Replace any media cards, discs, or any other parts that you removed before working on your computer.
4. Connect your computer and all attached devices to their electrical outlets.
 -  **NOTE:** To exit service mode, ensure to connect the AC adapter to the power-adapter port on your computer.
5. Press the power button to turn on the computer. Your computer will automatically return to normal functioning mode.

BitLocker

 **CAUTION:** If BitLocker is not suspended before updating the BIOS, the next time you reboot the system it will not recognize the BitLocker key. You will then be prompted to enter the recovery key to progress, and the system will ask for the recovery key on each reboot. If the recovery key is not known, this can result in data loss or an unnecessary operating system reinstall. For more information about this subject, see Knowledge Article: [updating the BIOS on Dell systems with BitLocker enabled](#).

The installation of the following components triggers BitLocker:

- Hard disk drive or solid-state drive
- System board

Recommended tools

The procedures in this document may require the following tools:

- Phillips screwdriver #0
- Phillips screwdriver #1
- Plastic scribe

Screw list

- NOTE:** When removing screws from a component, it is recommended to note the screw type, and the quantity of screws, and then place them in a screw storage box. This is to ensure that the correct number of screws and correct screw type is restored when the component is replaced.
- NOTE:** Some computers have magnetic surfaces. Ensure that the screws are not left attached to such surfaces when replacing a component.
- NOTE:** Screw color may vary with the configuration ordered.

Table 29. Screw list









Component	Screw type	Quantity	Screw image
Base cover	Captive	9	
Battery	Captive	5	
Heat sink - discrete graphics	Captive	7	
Heat sink - integrated graphics	Captive	4	
Display assembly	M2.5x5	6	
Display panel	M2.5x2.5	6	
Fan	M2x3	2	
I/O board	M2.5x5 M2x5 M2x3	3 2 1	
M.2230 solid-state drive	M2x2	2	
Power-adapter port	M2.5x5	3	
System board	M2x3 M2x5 M2.5x5	4 2 3	
Touchpad	M2x2	6	

Table 29. Screw list (continued)

Component	Screw type	Quantity	Screw image
Wireless-card	M2x3	1	

Major components of Latitude 3550

The following image shows the major components of Latitude 3550.

i **NOTE:** Dell provides a list of components and their part numbers for the original system configuration purchased. These parts are available according to warranty coverages purchased by the customer. Contact your Dell sales representative for purchase options.

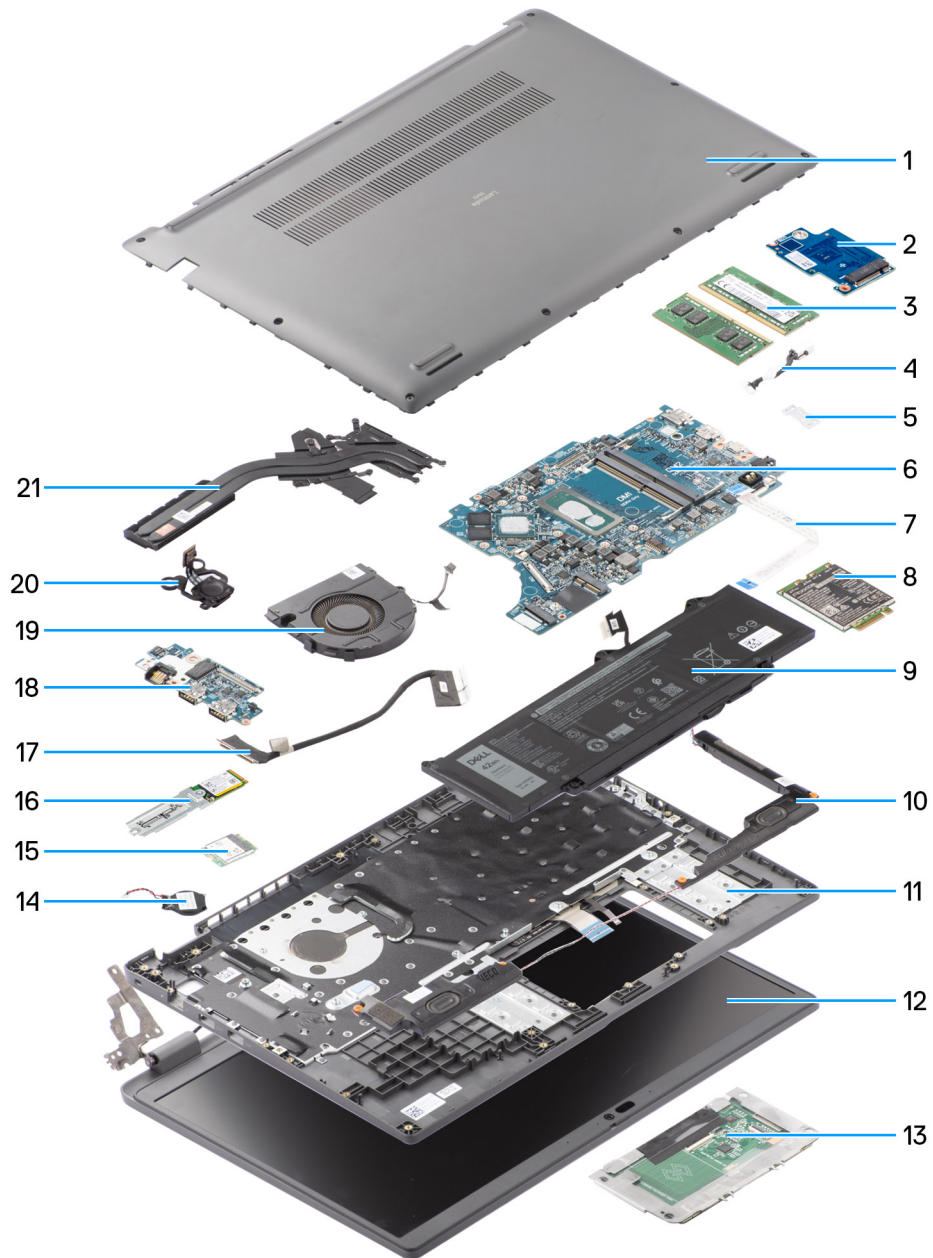

Figure 8. Exploded view

1. Base cover
2. I/O board
3. Memory modules
4. DC-in port cable
5. Bracket
6. System board
7. Touchpad cable
8. Wireless Card
9. Battery
10. Speaker
11. Palm-rest and keyboard assembly

12. Display assembly
13. Touchpad
14. Coin cell battery
15. WLAN card
16. M.2 2230 solid state drive
17. I/O board cable
18. I/O board
19. Fan
20. Power button
21. Heat sink

Removing and installing Customer Replaceable Units (CRUs)

The replaceable components in this chapter are Customer Replaceable Units (CRUs).

 **CAUTION:** Customers can replace only the Customer Replaceable Units (CRUs) following the safety precautions and replacement procedures.

 **NOTE:** The images in this document may differ from your computer depending on the configuration you ordered.

Base cover

Removing the base cover

Prerequisites

1. Follow the procedure in [Before working inside your computer](#).

About this task

The following images indicate the location of the base cover and provide a visual representation of the removal procedure.

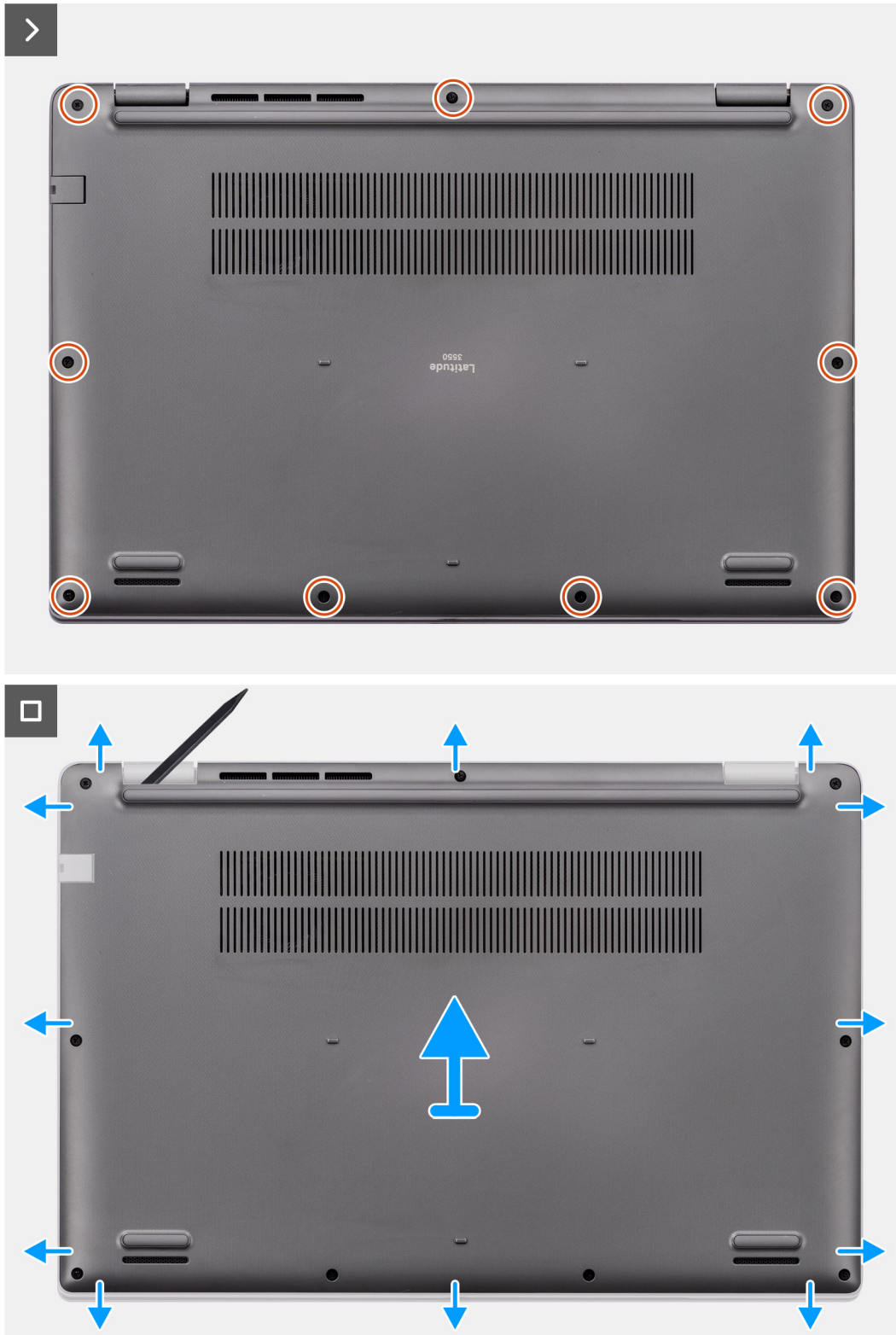
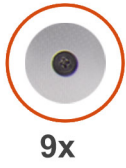

Figure 9. Removing the base cover

Steps

1. Loosen the nine captive screws that secure the base cover to the chassis.
2. Using a plastic scribe, pry open the base cover starting from the recesses, which are located in the U-shaped indents at the bottom edge of the base cover, near the hinges.
3. Pry open the top side of the base cover and continue working on the left, right and, bottom sides to open the base cover.
4. Carefully lift and remove the base cover from the chassis.

Installing the base cover

Prerequisites

If you are replacing a component, remove the existing component before performing the installation procedure.

About this task

The following images indicate the location of the base cover and provide a visual representation of the installation procedure.

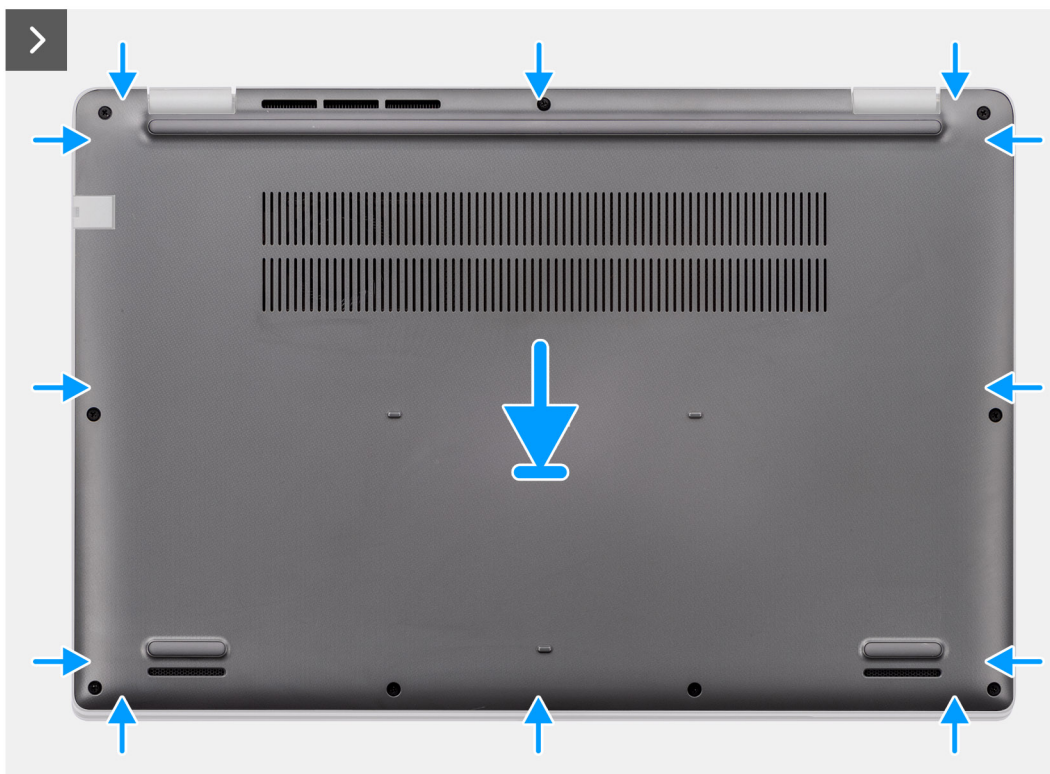

Figure 10. Installing the base cover

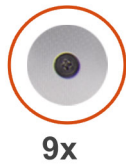

Figure 11. Installing the base cover

Steps

1. Place the base cover on top of the chassis.
2. Align the screw holes on the base cover with the screw holes on the palm-rest and keyboard assembly, and snap the base cover latches into place.
3. Tighten the nine captive screws to secure the base cover to the chassis.

Next steps

1. Follow the procedure in [After working inside your computer](#).

Memory module

Removing the memory module

Prerequisites

1. Follow the procedure in [Before working inside your computer](#).
2. Remove the [base cover](#).

About this task

The following images indicate the location of the memory module and provide a visual representation of the removal procedure.

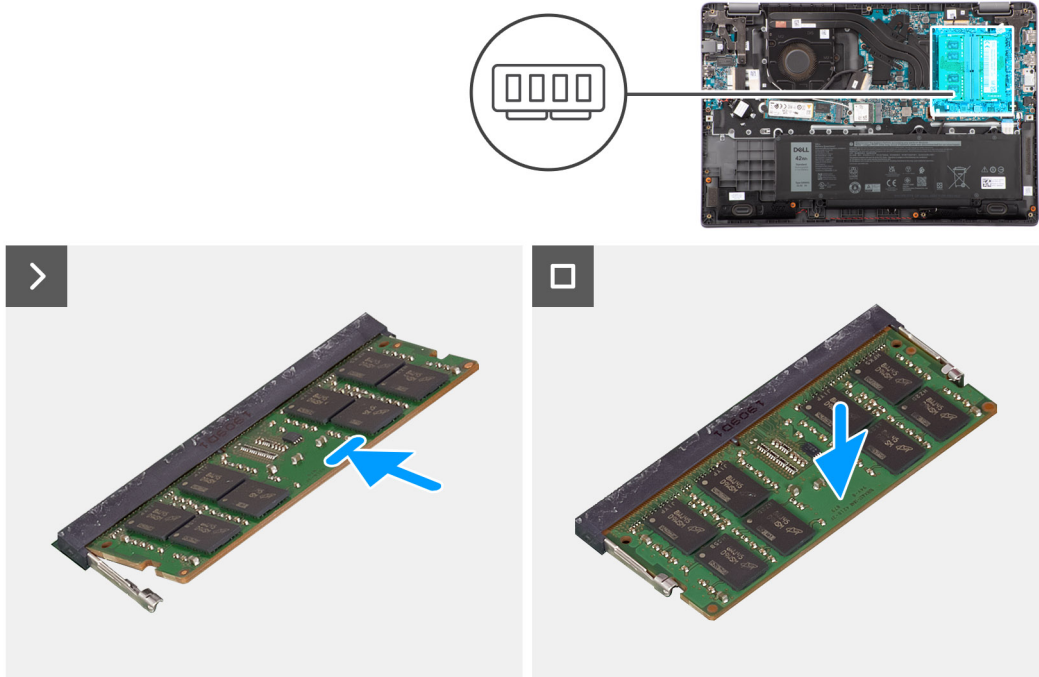

Figure 12. Removing the memory module

Steps

1. Pry the clips securing the memory module until the memory module pops-up.
2. Remove the memory module from the memory slot.

Installing the memory modules

Prerequisites

If you are replacing a component, remove the existing component before performing the installation procedure.

About this task

The figure indicates the location of the memory module and provides a visual representation of the installation procedure.

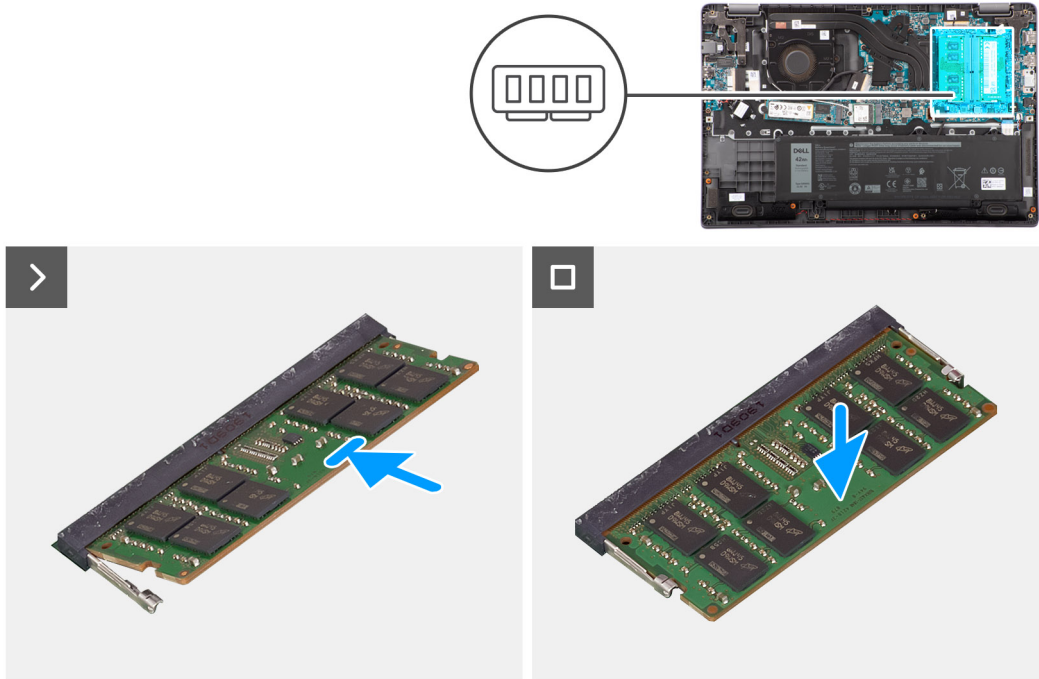

Figure 13. Installing the memory modules

Steps

1. Align the notch on the memory module with the tab on the memory module slot.
2. Slide the memory module firmly into the slot at an angle.
3. Press the memory module down until it clicks into place.

NOTE: If you do not hear the click, remove the memory module and reinstall it.

Next steps

1. Install the [base cover](#).
2. Follow the procedure in [After working inside your computer](#).

Wireless card

Removing the wireless card

Prerequisites

1. Follow the procedure in [Before working inside your computer](#).
2. Remove the [base cover](#).

About this task

The following images indicate the location of the wireless card and provide a visual representation of the removal procedure.

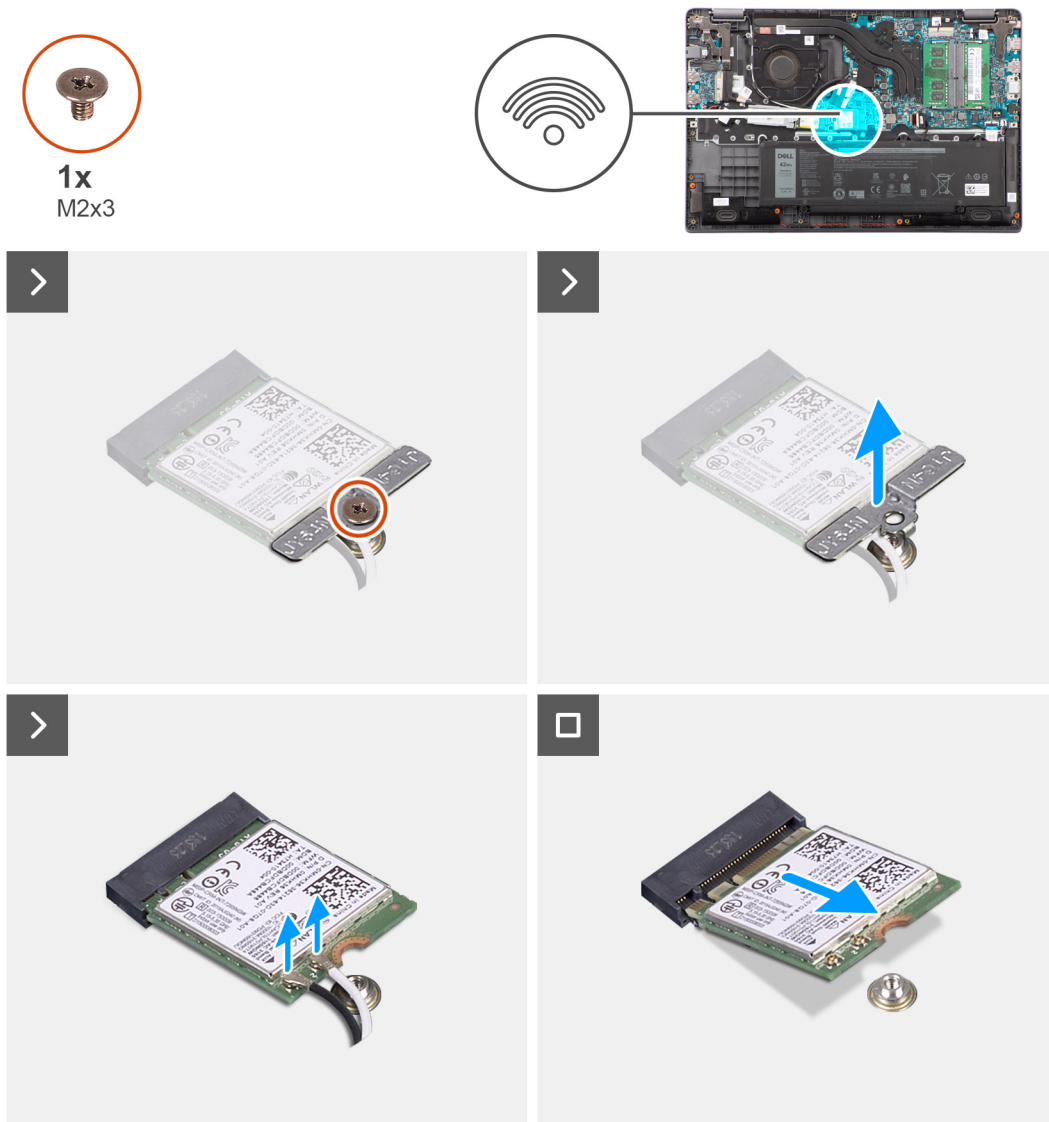

Figure 14. Removing the wireless card

Steps

1. Remove the screw (M2x3) that secures wireless-card bracket to the system board.
2. Slide and remove the wireless-card bracket from the system.
3. Disconnect the WLAN-antenna cables from the respective connectors on the wireless card.
4. Lift and remove the wireless card from the wireless card slot on the system board.

Installing the wireless card

Prerequisites

If you are replacing a component, remove the existing component before performing the installation procedure.

About this task

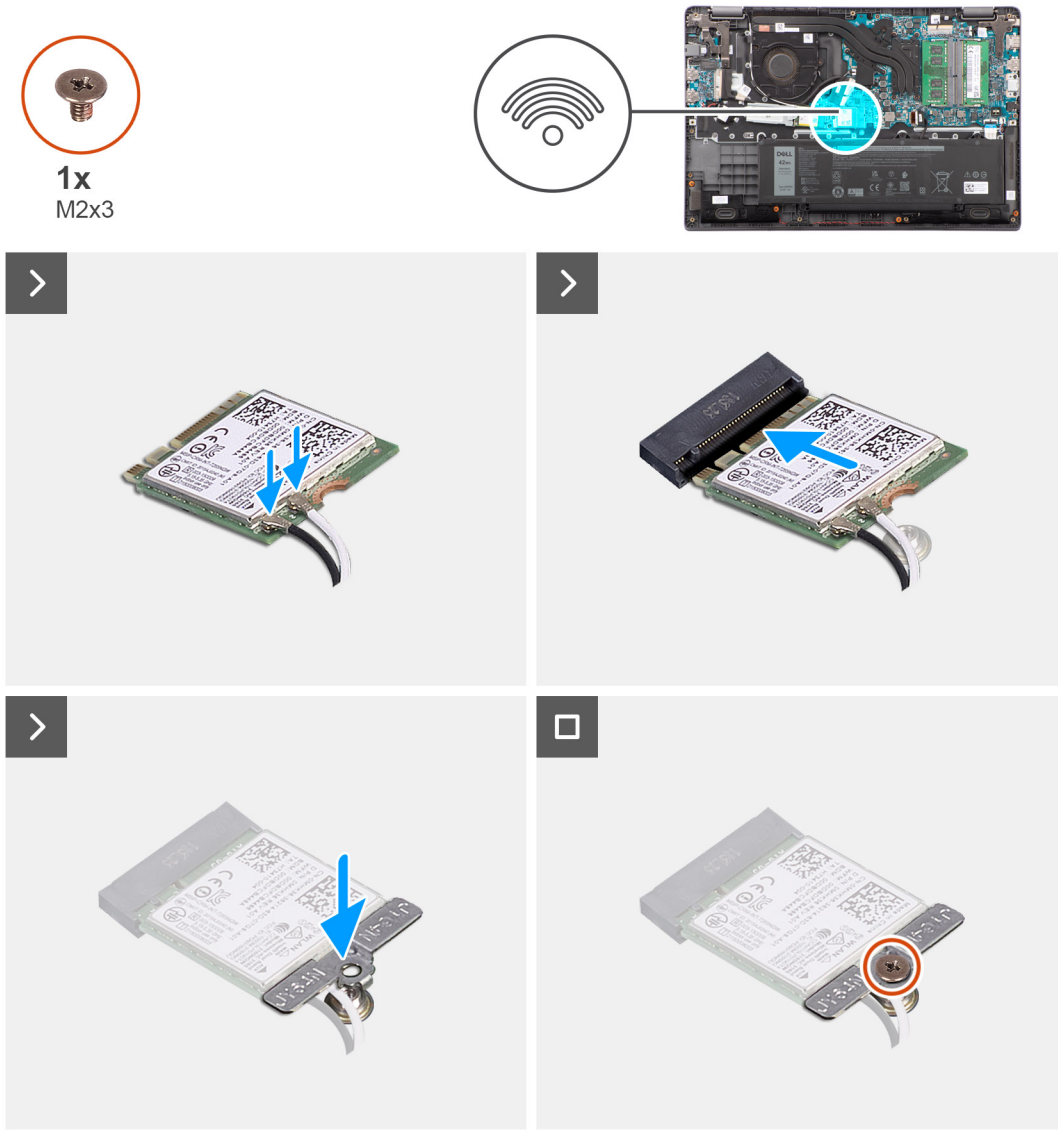

Figure 15. Installing the wireless card

Steps

1. Connect the WLAN-antenna cables to the respective connectors on the wireless card.
(i) **NOTE:** The WLAN-antenna cable connectors are fragile, and utmost care should be taken while replacing them.

Table 30. WLAN-antenna cable color scheme

Connectors on the wireless card	Antenna-cable color
Main - White triangle (△) on the wireless module of the system board	White cable
Auxiliary - Solid triangle (▲) on the wireless module of the system board	Black cable

2. Align the notch on the wireless card with the tab on the wireless card slot.
3. Slide the wireless card at an angle into the wireless card slot.
4. Place the wireless-card bracket on the wireless card.
5. Align the screw hole on the wireless-card bracket with the screw hole on the system board.

- Replace the screw (M2x3) to secure the wireless-card bracket and the wireless card to the system board.

Next steps

- Install the [base cover](#).
- Follow the procedure in [After working inside your computer](#).

Wireless Wide Area Network (WWAN) card

Removing the WWAN card

Prerequisites

- Follow the procedure in [Before working inside your computer](#).
- Remove the [base cover](#).

About this task

The figure indicates the location of the WWAN card and provides a visual representation of the removal procedure.

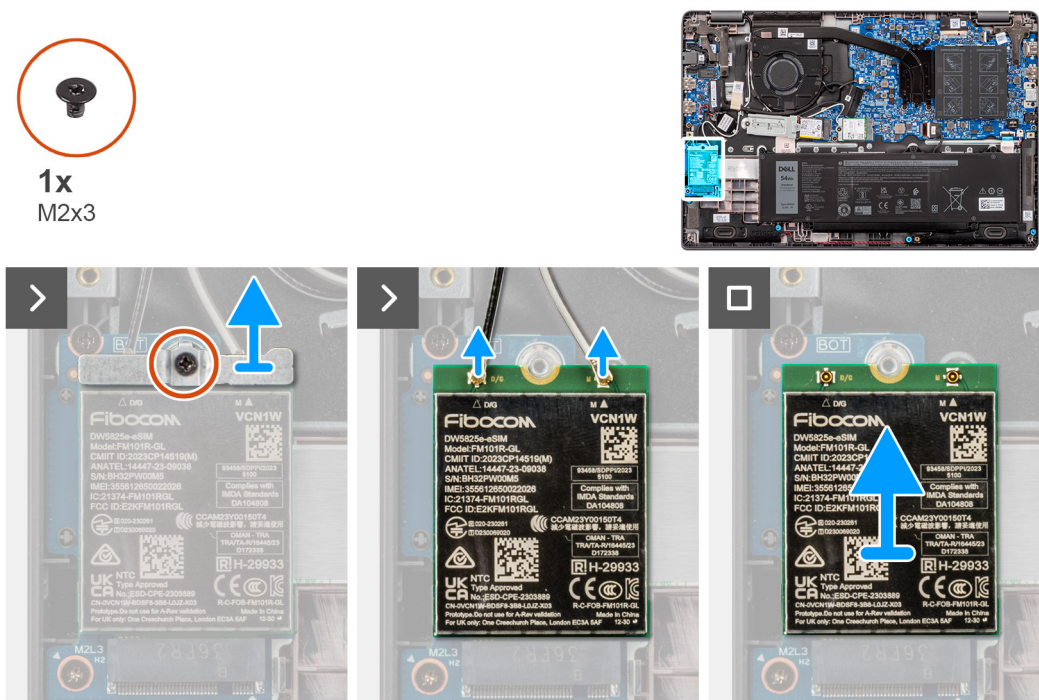

Figure 16. Removing the WWAN card

Steps

- Remove the screw (M2x3) that secures the WWAN bracket to the computer.
- Remove the WWAN bracket.
- Disconnect the WWAN antenna cables from the WWAN module.
- Slide and remove the WWAN card from the WWAN card slot.

Installing the WWAN card

Prerequisites

If you are replacing a component, remove the existing component before performing the installation procedure.

About this task

The figure indicates the location of the WWAN card and provides a visual representation of the installation procedure.

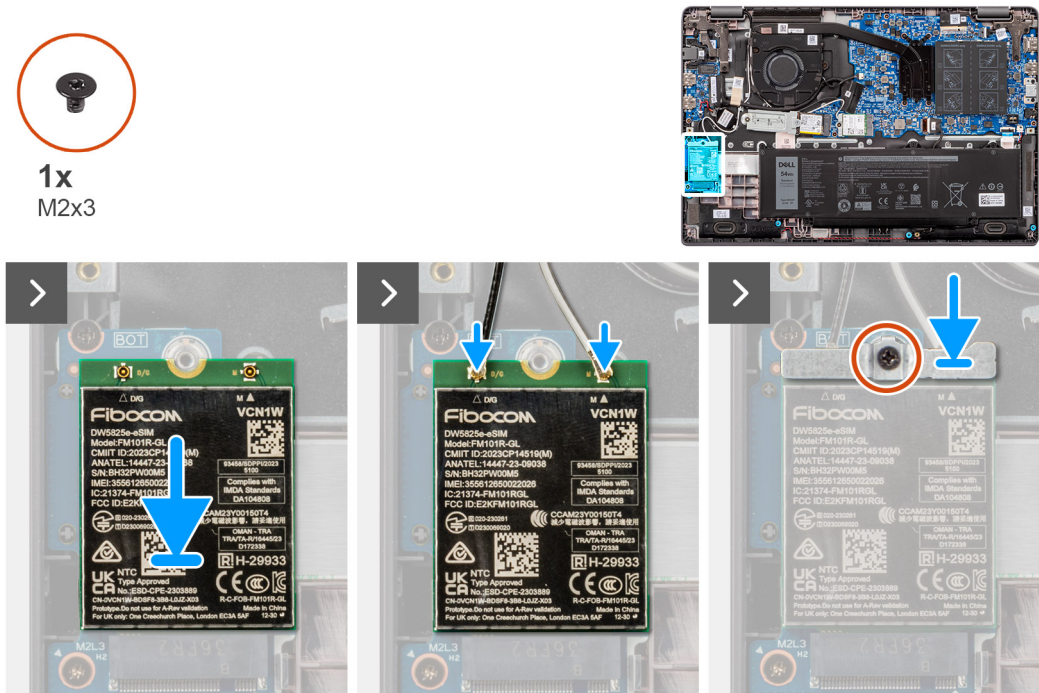

Figure 17. Installing the WWAN card

Steps

1. Align the notch on the WWAN card with the tab on the WWAN-card slot and insert the WWAN card at an angle into the WWAN-card slot.
2. Connect the WWAN antenna cables to the WWAN card.
3. Align and place the WWAN-card bracket to secure the WWAN card to the system board.
4. Replace the screw (M2x3) to secure the WWAN card to the system board.

Next steps

1. Install the [base cover](#).
2. Follow the procedure in [After working inside your computer](#).

Coin-cell battery

Removing the coin-cell battery

Prerequisites

1. Follow the procedure in [Before working inside your computer](#).
2. Remove the [base cover](#).

About this task

NOTE: When the coin-cell battery is removed, it clears the CMOS settings.

The following image indicates the location of the coin-cell battery and provides a visual representation of the removal procedure.

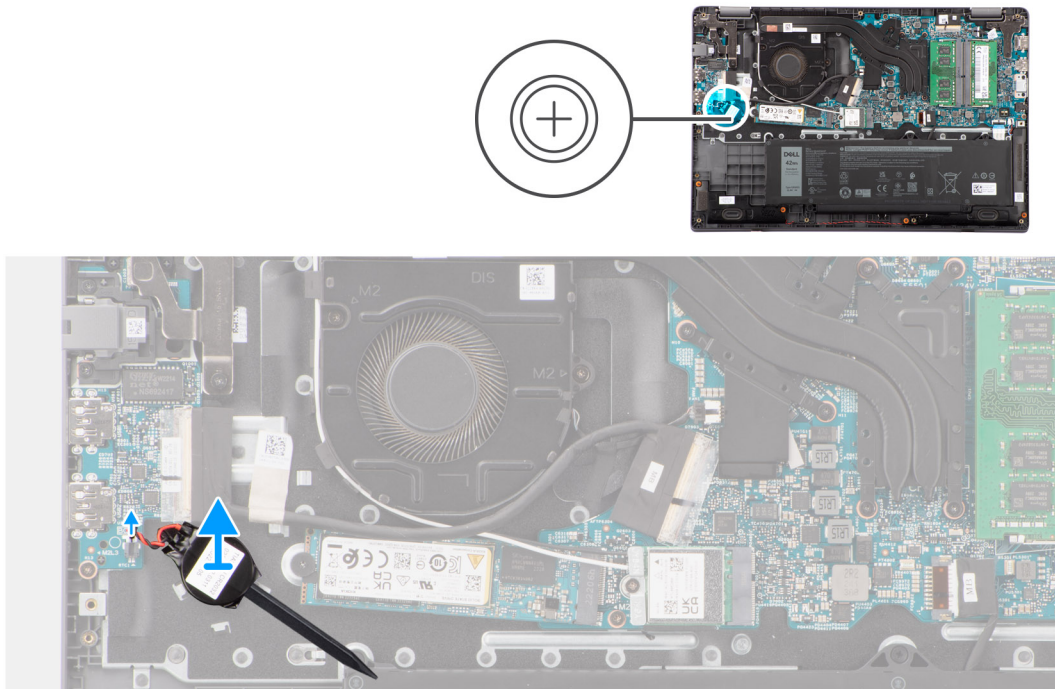

Figure 18. Removing the coin-cell battery

Steps

1. Disconnect the coin-cell battery cable from the connector on the system board.
2. Using a plastic scribe, pry the coin-cell battery off its slot on the palm-rest and keyboard assembly.

Installing the coin-cell battery

Prerequisites

If you are replacing a component, remove the existing component before performing the installation procedure.

About this task

The following image indicates the location of the coin-cell battery and provides a visual representation of the installation procedure.

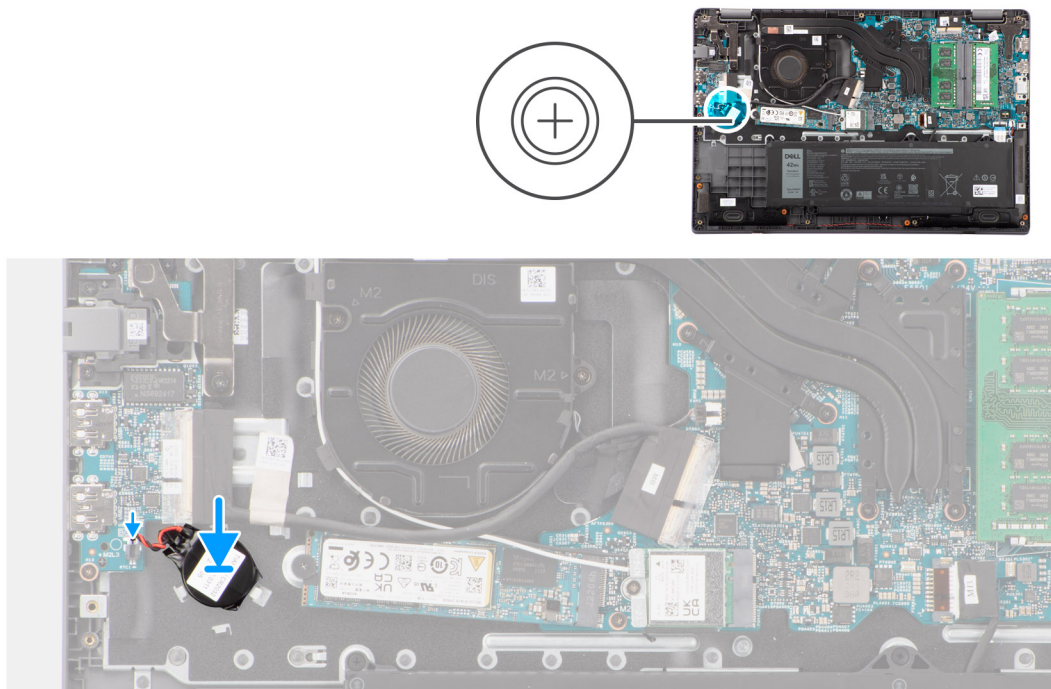

Figure 19. Installing the coin-cell battery

Steps

1. Align and place the coin-cell battery into its slot on the palm-rest and keyboard assembly.
2. Connect the coin-cell battery cable to the connector on the system board.

Next steps

1. Install the [base cover](#).
2. Follow the procedure in [After working inside your computer](#).

Speakers

Removing the speakers

Prerequisites

1. Follow the procedure in [Before working inside your computer](#).
2. Remove the [base cover](#).

About this task

The following images indicate the location of the speakers and provide a visual representation of the removal procedure.

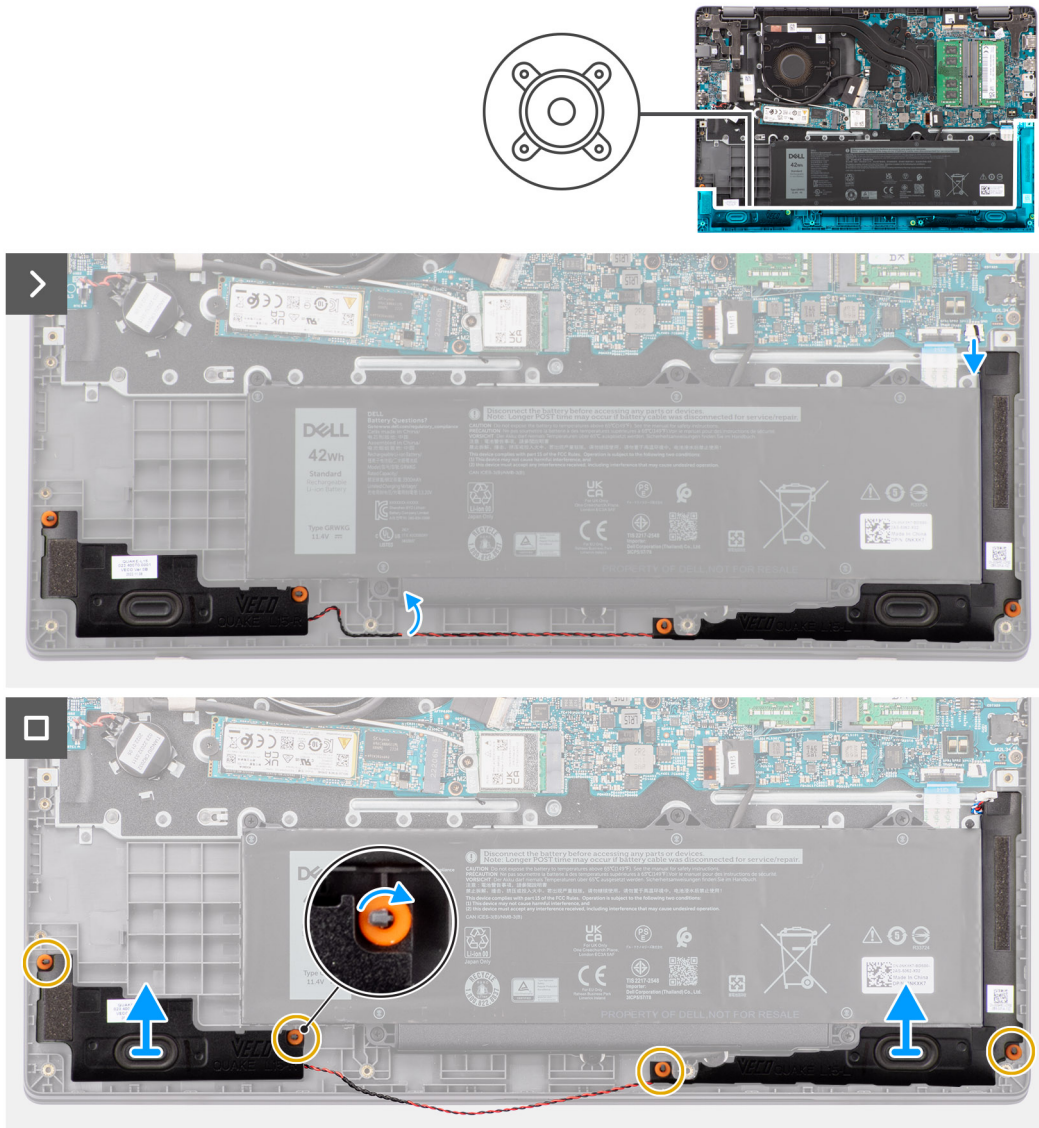

Figure 20. Removing the speakers

Steps

1. Disconnect the speaker cable from the connector on the system board.
2. Unroute the speaker cable from the routing guides on the palm-rest and keyboard assembly.
3. Remove the speakers from the palm-rest keyboard and assembly.

Installing the speakers

Prerequisites

If you are replacing a component, remove the existing component before performing the installation procedure.

About this task

NOTE: If the rubber grommets are pushed out when removing the speakers, push them back in place before replacing the speakers.

The following images indicate the location of the speakers and provide a visual representation of the installation procedure

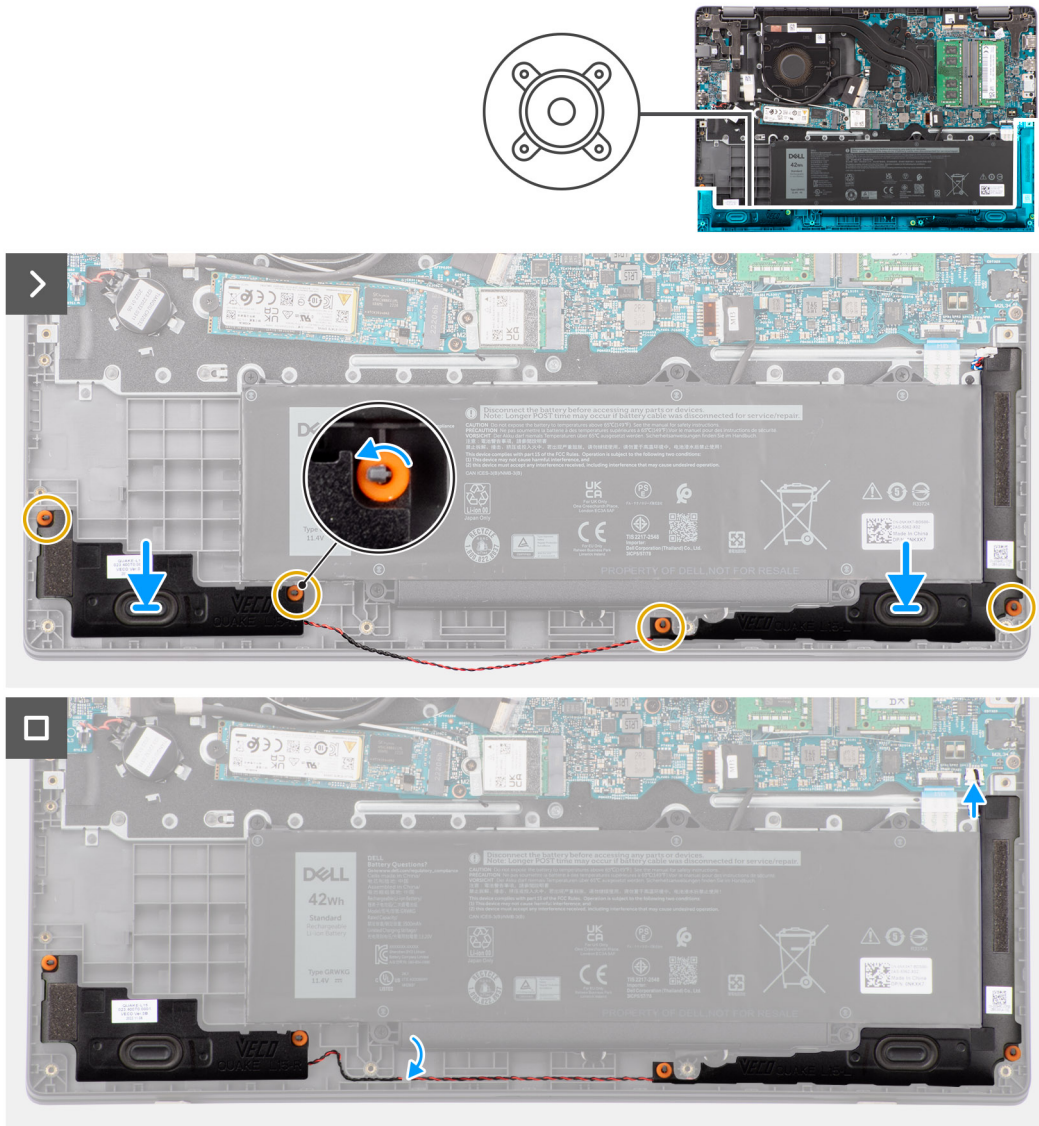

Figure 21. Installing the speakers

Steps

1. Using the alignment posts and rubber grommets, place the speakers in their slots on the palm-rest and keyboard assembly.
2. Route the speaker cables through the routing guides on the palm-rest and keyboard assembly.
3. Connect the speaker cable to the connector on the system board.
4. Ensure that the alignment posts are threaded through the rubber grommets on the speakers.
5. After placing the speakers on the palm-rest and keyboard assembly, ensure that rubber grommets are seated into the slot and installed on the speakers correctly.

Next steps

1. Install the [base cover](#).
2. Follow the procedure in [After working inside your computer](#).

M.2 solid state drive

Removing the M.2 2230 solid-state drive

Prerequisites

1. Follow the procedure in [Before working inside your computer](#).
2. Remove the [base cover](#).

About this task

NOTE: This procedure applies only to systems shipped with a M.2 2230 solid-state drive installed.

NOTE: The M.2 solid-state drive that is installed on your system depends on the configuration ordered. Supported card configurations on the M.2 solid-state drive slot is M.2 2230 solid-state drive.

The following images indicate the location of the M.2 2230 solid-state drive and provide a visual representation of the removal procedure.

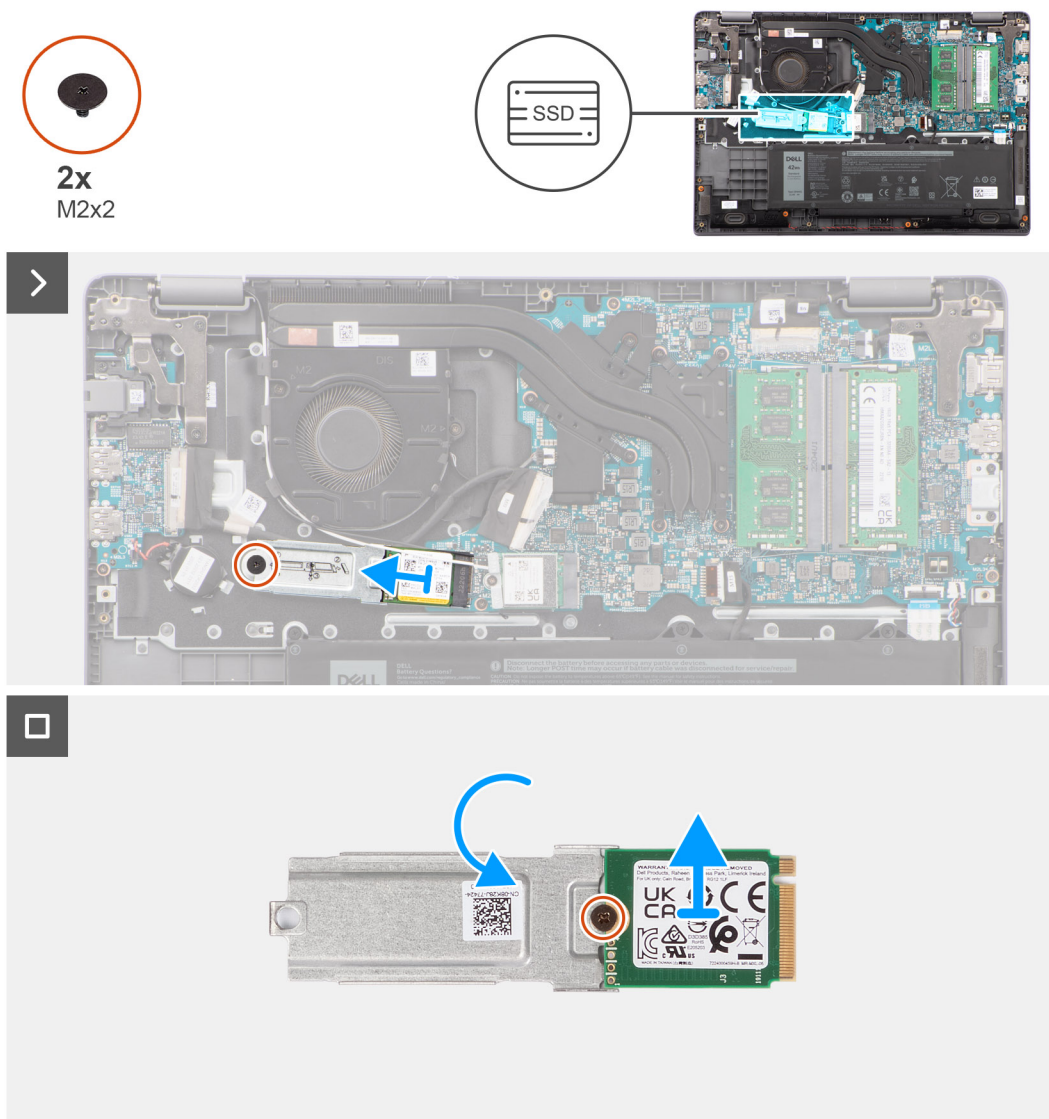

Figure 22. Removing the M.2 2230 solid-state drive

Steps

1. Remove the screw (M2x2) to secure the M.2 2230 solid-state drive holder to the system board.
2. Lift the M.2 2230 solid-state drive holder off the palm-rest and keyboard assembly.
3. Flip the M.2 2230 solid-state drive holder and remove the single screw (M2x2) that secures the M.2 2230 solid-state drive to the M.2 2230 solid-state drive holder.
4. Remove the M.2 2230 solid-state drive.

Installing the M.2 2230 solid-state drive

Prerequisites

If you are replacing a component, remove the existing component before performing the installation procedure.

About this task

The following images indicate the location of the M.2 2230 solid-state drive and provide a visual representation of the installation procedure.

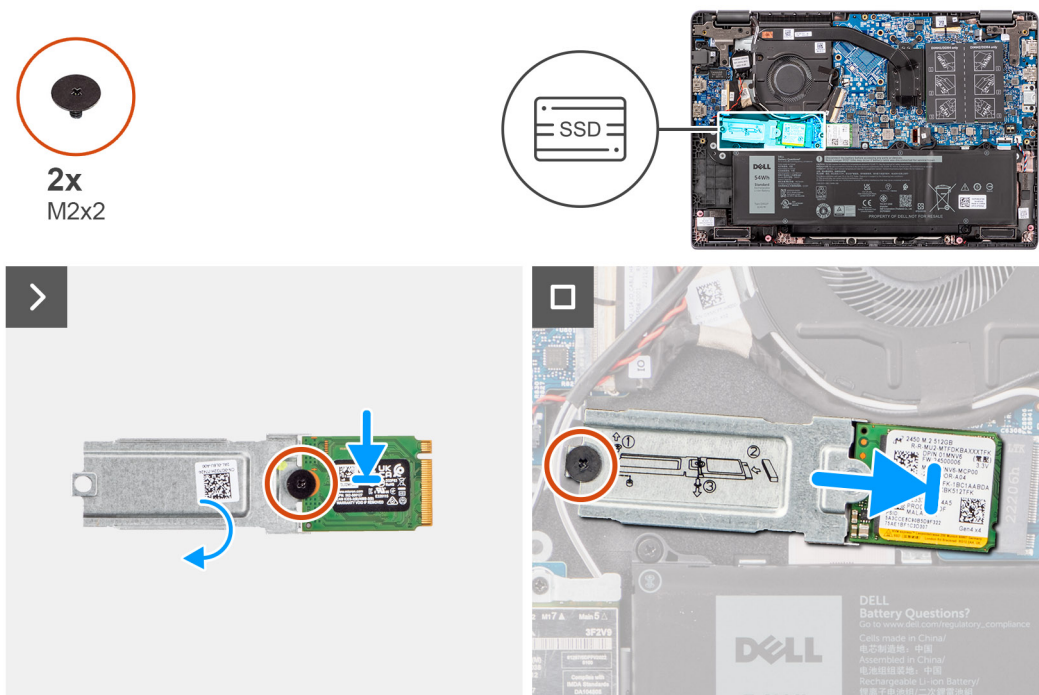

Figure 23. Installing the M.2 2230 solid-state drive

Steps

1. Align the notch on the M.2 2230 solid-state drive with the tab on the M.2 2230 solid-state drive holder.
2. Replace the single screw (M2x2) that secures the M.2 2230 solid-state drive to the M.2 2230 solid-state drive holder.
3. Slide the M.2 2230 solid-state drive into the M.2 card connector on the system board.
4. Align the screw hole on the M.2 2230 solid-state drive holder with the screw hole on the palm-rest and keyboard assembly.
5. Replace the screw (M2x2) to secure the M.2 2230 solid-state drive holder to the system board.

Next steps

1. Install the [base cover](#).
2. Follow the procedure in [After working inside your computer](#).

Removing and installing Field Replaceable Units (FRUs)

The replaceable components in this chapter are Field Replaceable Units (FRUs).

CAUTION: The information in this section is intended for authorized service technicians only.

CAUTION: To avoid any potential damage to the component or loss of data, ensure that an authorized service technician replaces the Field Replaceable Units (FRUs).

CAUTION: Dell Technologies recommends that this set of repairs, if needed, to be conducted by trained technical repair specialists.

CAUTION: As a reminder, your warranty does not cover damages that may occur during FRU repairs that are not authorized by Dell Technologies.

NOTE: The images in this document may differ from your computer depending on the configuration you ordered.

Battery

Rechargeable Li-ion battery precautions

CAUTION:

- Exercise caution when handling rechargeable Li-ion batteries.
- Discharge the battery completely before removing it. Disconnect the AC power adapter from the computer and operate the computer solely on battery power—the battery is fully discharged when the computer no longer turns on when the power button is pressed.
- Do not crush, drop, mutilate, or penetrate the battery with foreign objects.
- Do not expose the battery to high temperatures, or disassemble battery packs and cells.
- Do not apply pressure to the surface of the battery.
- Do not bend the battery.
- Do not use tools of any kind to pry on or against the battery.
- Ensure any screws during the servicing of this product are not lost or misplaced, to prevent accidental puncture or damage to the battery and other computer components.
- If the battery gets stuck inside your computer as a result of swelling, do not try to release it as puncturing, bending, or crushing a rechargeable Li-ion battery can be dangerous. In such an instance, contact Dell technical support for assistance. See www.dell.com/contactdell.
- Always purchase genuine batteries from www.dell.com or authorized Dell partners and resellers.
- Swollen batteries should not be used and should be replaced and disposed properly. For guidelines on how to handle and replace swollen rechargeable Li-ion batteries, see [Handling swollen rechargeable Li-ion batteries](#).

Removing the battery

Prerequisites

1. Follow the procedure in [Before working inside your computer](#).
2. Remove the [base cover](#).

About this task

The following images indicate the location of the battery and provide a visual representation of the removal procedure.

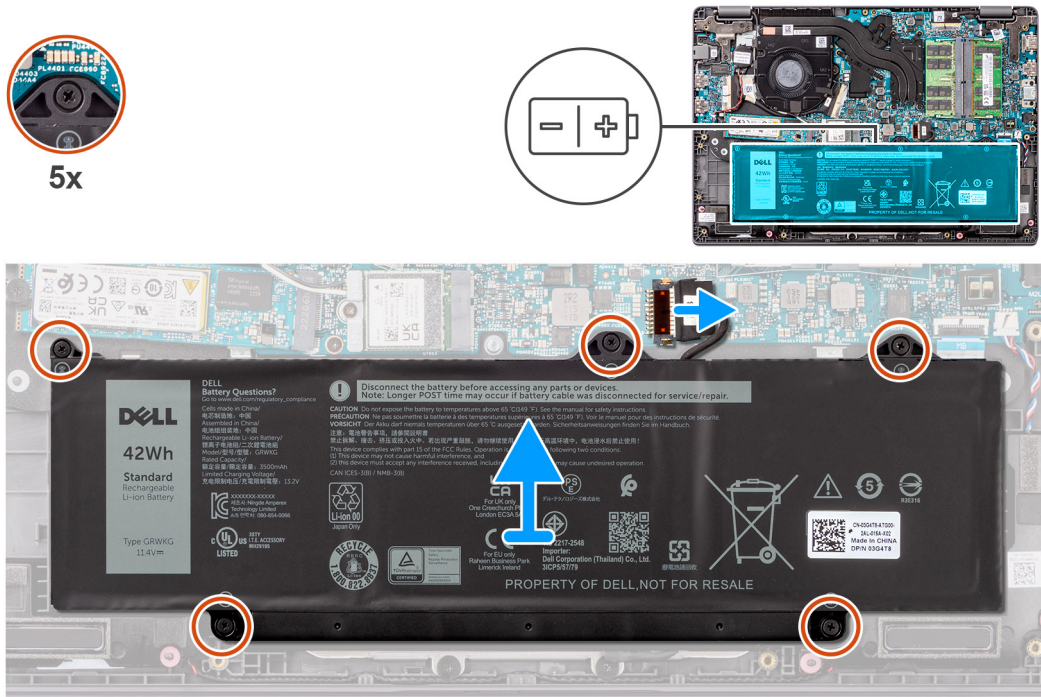
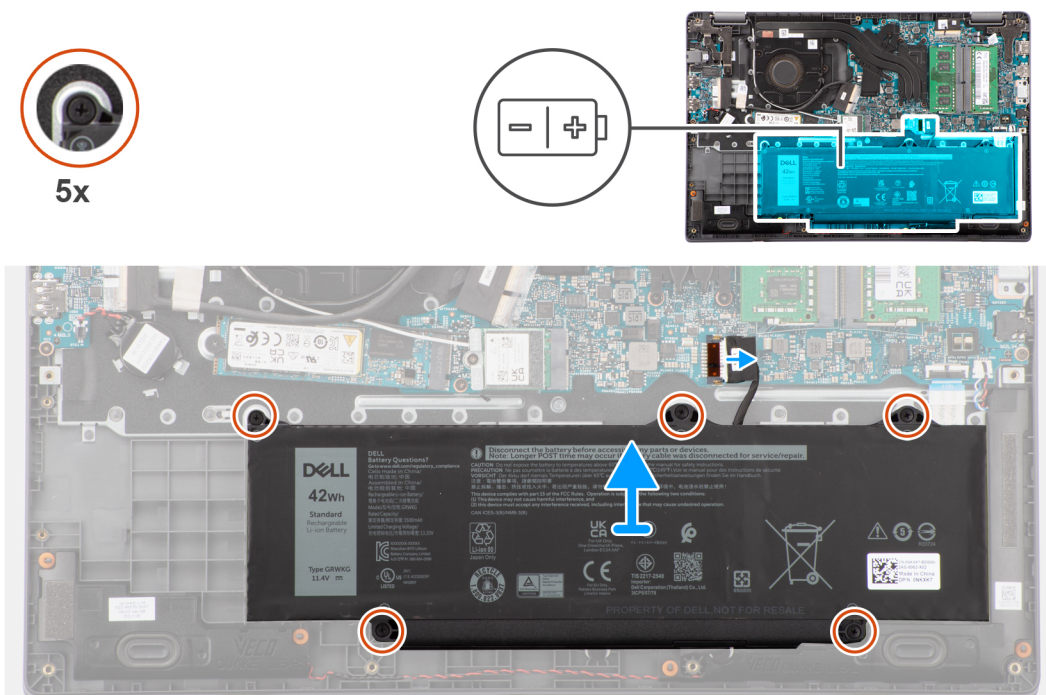

Figure 24. Removing the battery



Steps

1. Use the pull tab to disconnect the battery cable from the connector on the system board.
2. Loosen the five captive screws that secure the battery to the palm-rest and keyboard assembly.
3. Lift the battery off the palm-rest and keyboard assembly.

Installing the battery

Prerequisites

If you are replacing a component, remove the existing component before performing the installation procedure.

About this task

The following images indicate the location of the battery and provide a visual representation of the installation procedure.

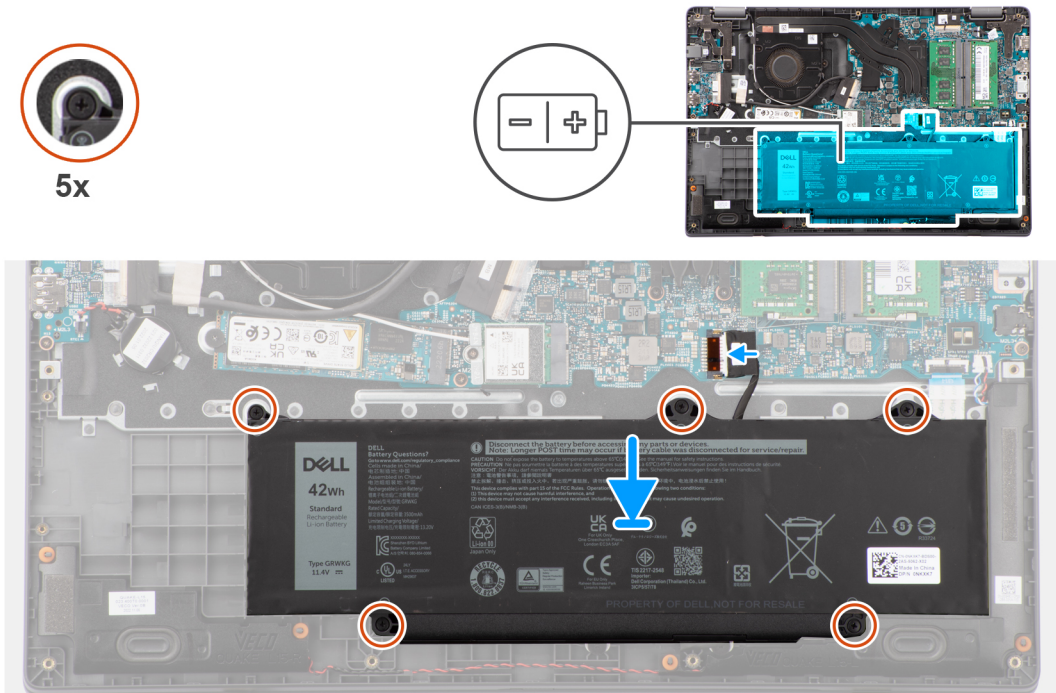

Steps

1. Align the screw holes on the battery to the screw holes on the palm-rest and keyboard assembly.
2. Tighten the five captive screws to secure the battery to the palm-rest and keyboard assembly.
3. Connect the battery cable to the connector on the system board.

Next steps

1. Install the [base cover](#).
2. Follow the procedure in [After working inside your computer](#).

Battery cable

Removing the battery cable

Prerequisites

1. Follow the procedure in [Before working inside your computer](#).
2. Remove the [base cover](#).
3. Remove the [battery](#).

About this task

The following image indicates the location of the battery cable and provides a visual representation of the removal procedure.

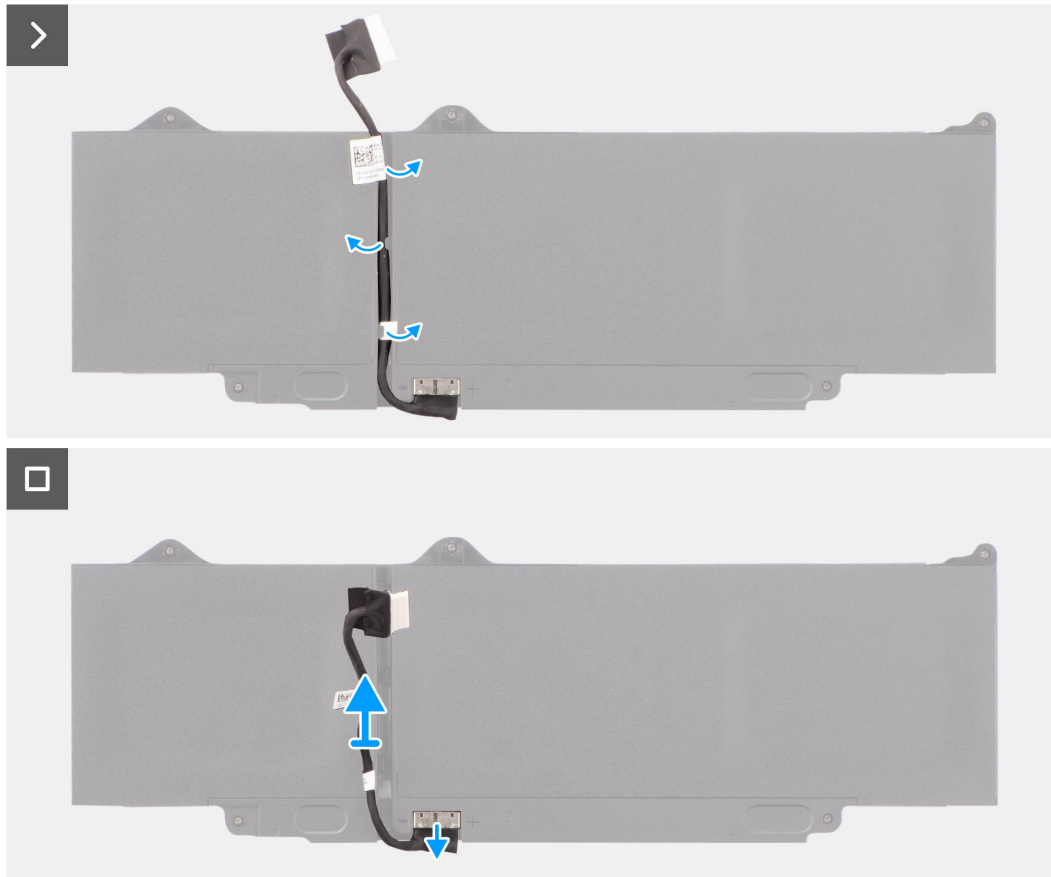

Figure 25. Removing the battery cable

Steps

1. Unroute the battery cable from the routing guides on the battery.
2. Disconnect the battery cable from the connector on the battery.
3. Lift the battery cable away from the battery.

Installing the battery cable

Prerequisites

If you are replacing a component, remove the existing component before performing the installation procedure.

About this task

The following image indicates the location of the battery cable and provides a visual representation of the installation procedure.

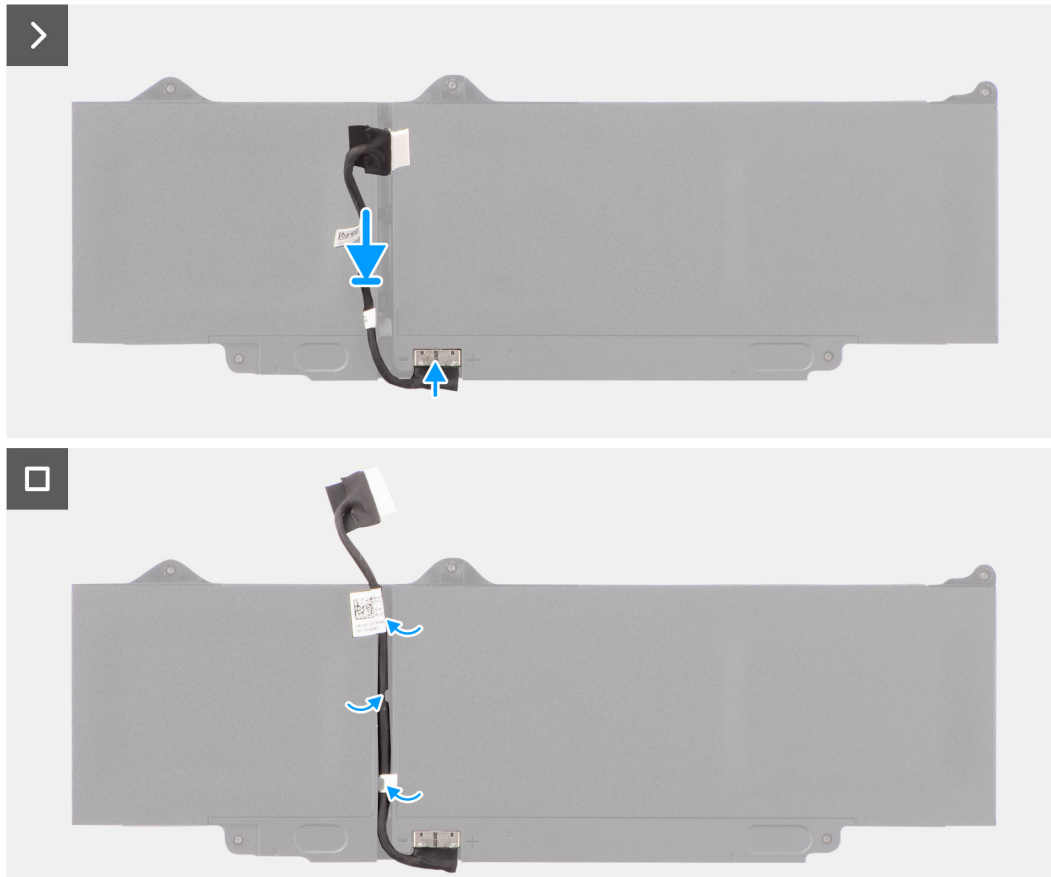

Figure 26. Installing the battery cable

Steps

1. Connect the battery cable to the connector on the battery.
2. Route the battery cable through the routing guides on the battery.

Next steps

1. Install the [battery](#).
2. Install the [base cover](#).
3. Follow the procedure in [After working inside your computer](#).

Power-adapter port

Removing the power-adapter port

Prerequisites

1. Follow the procedure in [Before working inside your computer](#).
2. Remove the [base cover](#).

About this task

The following images indicate the location of the power-adapter port and provide a visual representation of the removal procedure.

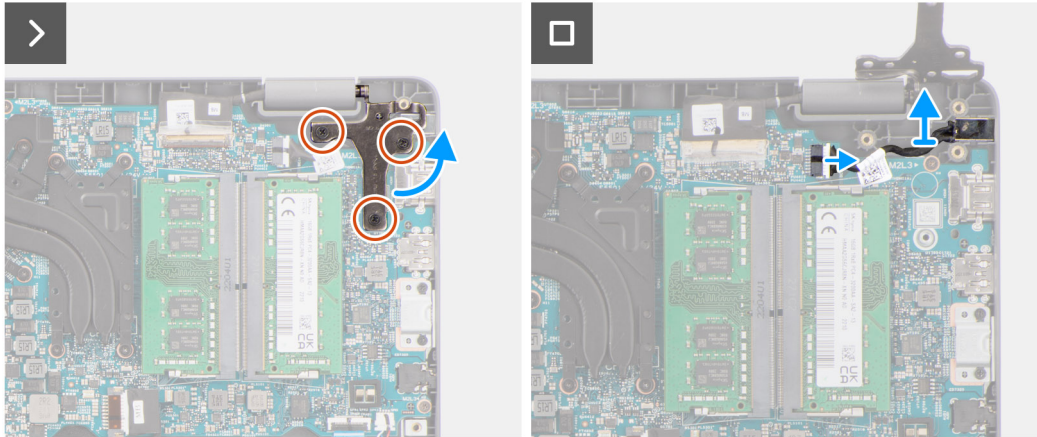
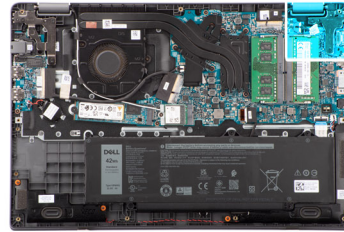

Figure 27. Removing the power-adapter port

Steps

1. Remove the three screws (M2.5x5) that secure the right display hinge to the system.
2. Lift the right display hinge in upward direction away from the system.
3. Disconnect the power-adapter port cable from the connector on the system board and remove the power-adapter port from the system board.

Installing the power-adapter port

Prerequisites

If you are replacing a component, remove the existing component before performing the installation procedure.

About this task

The following images indicate the location of the power-adapter port and provide a visual representation of the installation procedure.



3x
M2.5x5

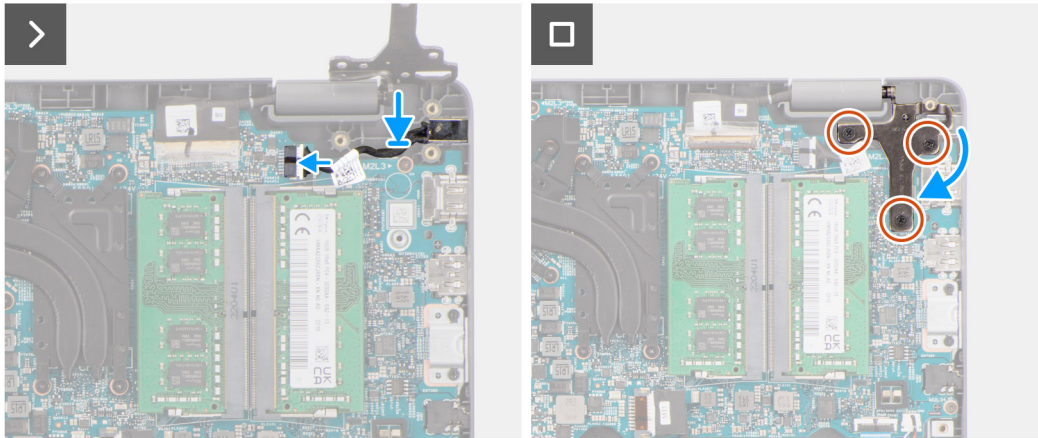
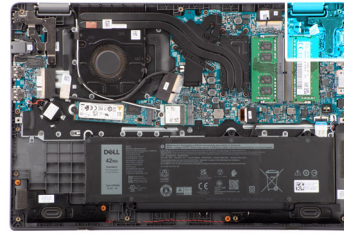

Figure 28. Installing the power-adapter port

Steps

1. Align and place the power-adapter port on the system board.
2. Connect the power-adapter port cable to the connector on the system board.
3. Gently press the right display hinge in downward direction towards the system.
4. Align the screw holes on the right display hinge with the screw holes on the system.
5. Replace the three screws (M2.5x5) to secure the right display hinge to the system.

Next steps

1. Install the [base cover](#).
2. Follow the procedure in [After working inside your computer](#).

Heat sink

Removing the heat-sink for integrated graphics

Prerequisites

1. Follow the procedure in [Before working inside your computer](#).
2. Remove the [base cover](#).

About this task

NOTE: The heat-sink may become hot during normal operation. Allow sufficient time for the heat-sink to cool before you touch it.

NOTE: For maximum cooling of the processor, do not touch the heat-transfer areas on the heat-sink. The oils in your skin can reduce the heat-transfer capability of the thermal grease.

The following image indicates the location of the heat-sink and provides a visual representation of the removal procedure.

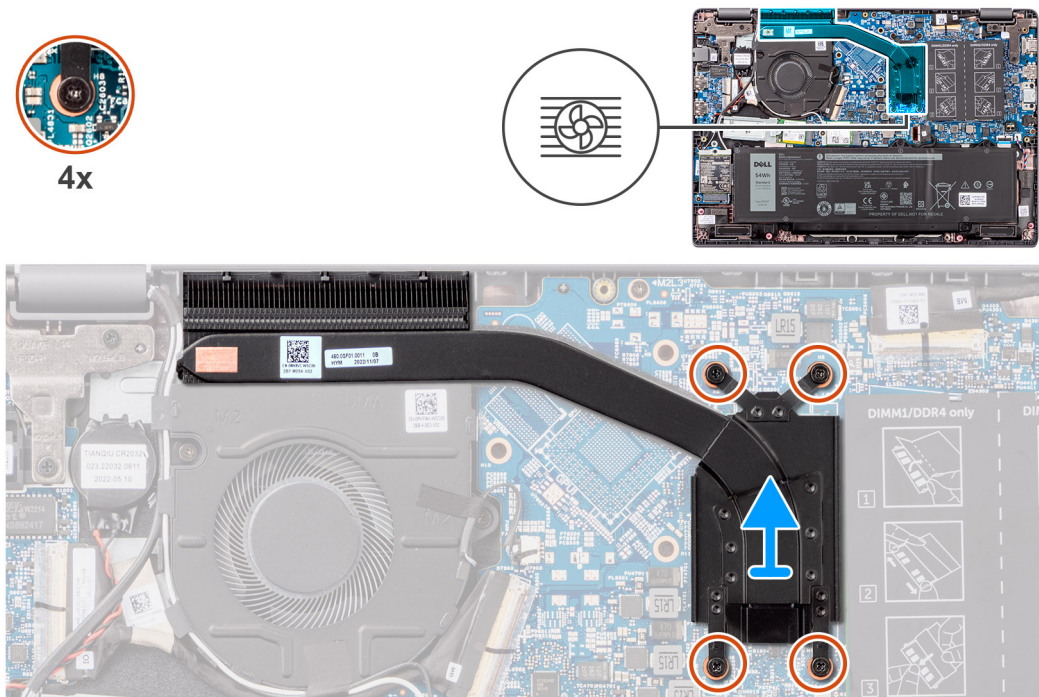

Figure 29. Removing the heat-sink for integrated graphics

Steps

1. Loosen the four captive screws that secure the heat-sink to the system board in the reverse sequential order mentioned on the heat-sink [4 > 3 > 2 > 1].
2. Lift and remove the heat-sink from the system board.

Installing the heat-sink for integrated graphics

Prerequisites

If you are replacing a component, remove the existing component before performing the installation procedure.

About this task

NOTE: If either the system board or the heat-sink is replaced, use the thermal grease provided in the kit to ensure that thermal conductivity is achieved.

The following image indicates the location of the heat-sink and provides a visual representation of the installation procedure.

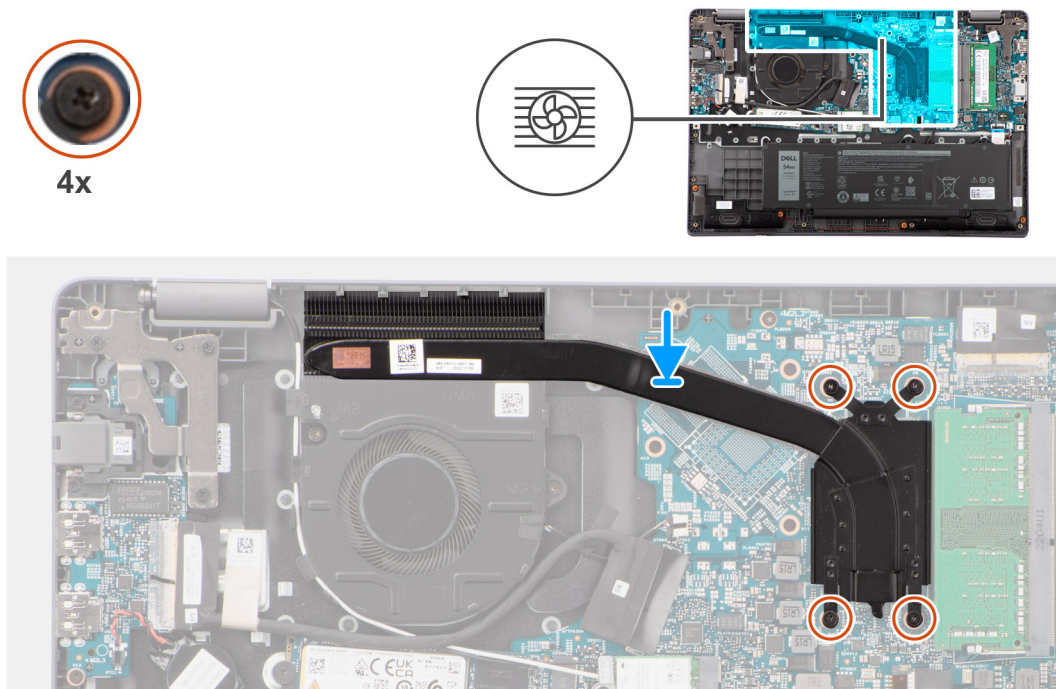

Figure 30. Installing the heat-sink for integrated graphics

Steps

1. Place the heat-sink into its slot on the system board.
2. Align the screw holes on the heat-sink to the screw holes on the system board in the sequential order mentioned on the heat-sink [1 > 2 > 3 > 4] .
3. Tighten the four captive screws to secure the heat-sink to the system board.

Next steps

1. Install the [base cover](#).
2. Follow the procedure in [After working inside your computer](#).

Removing the heat-sink for discrete graphics

Prerequisites

1. Follow the procedure in [Before working inside your computer](#).
2. Remove the [base cover](#).

About this task

- NOTE:** The heat-sink may become hot during normal operation. Allow sufficient time for the heat-sink to cool before you touch it.
- NOTE:** For maximum cooling of the processor, do not touch the heat transfer areas on the heat-sink. The oils in your skin can reduce the heat transfer capability of the thermal grease.

The following image indicates the location of the heat-sink and provides a visual representation of the removal procedure.

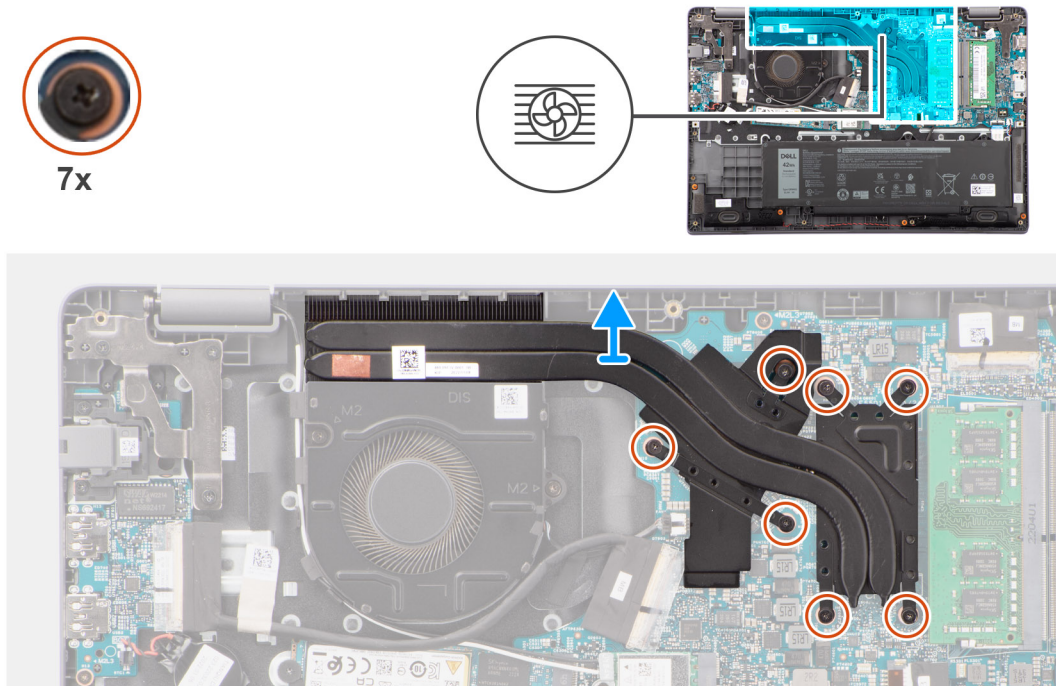

Figure 31. Removing the heat-sink for discrete graphics

Steps

1. Loosen the seven captive screws that secure the heat-sink to the system board in the reverse sequential order mentioned on the thermal heat-sink [7 > 6 > 5 > 4 > 3 > 2 > 1].
2. Lift and remove the heat-sink from the system board.

Installing the heat-sink for discrete graphics

Prerequisites

If you are replacing a component, remove the existing component before performing the installation procedure.

About this task

NOTE: If either the system board or the heat-sink is replaced, use the thermal grease that is provided in the kit to ensure that thermal conductivity is achieved.

The following image indicates the location of the heat-sink and provides a visual representation of the installation procedure.

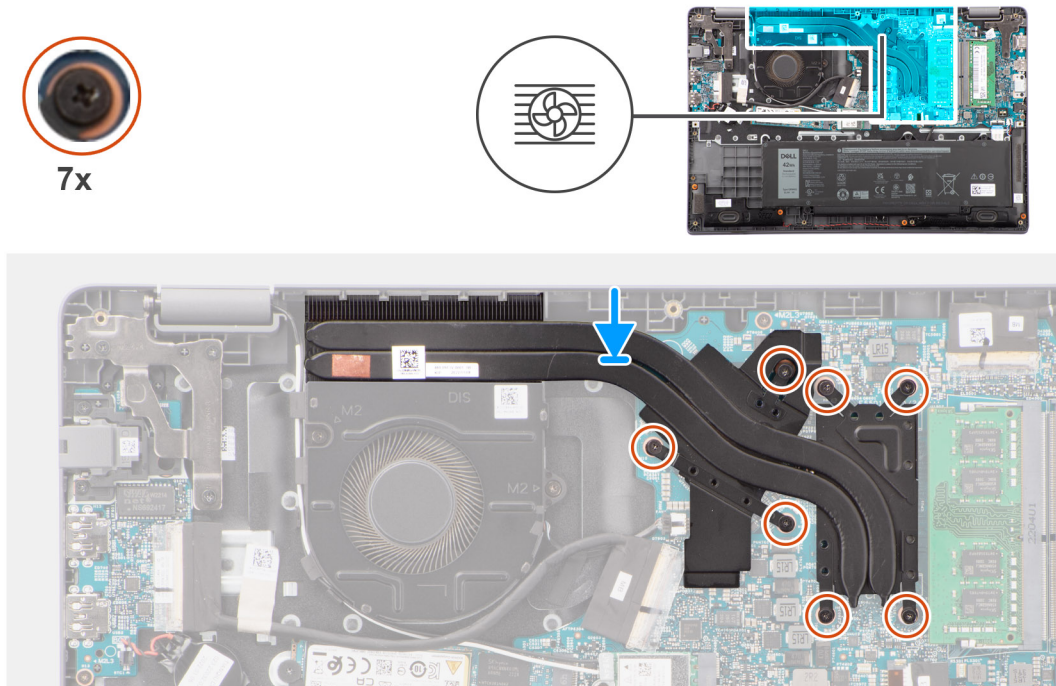

Figure 32. Installing the heat-sink for discrete graphics

Steps

1. Place the heat-sink into its slot on the system board.
2. Align the screw holes on the heat-sink to the screw holes on the system board in the sequential order mentioned on the heat-sink [1 > 2 > 3 > 4 > 5 > 6 > 7] .
3. Tighten the seven captive screws to secure the heat-sink to the system board.

Next steps

1. Install the [base cover](#).
2. Follow the procedure in [After working inside your computer](#).

Fan

Removing the fan

Prerequisites

1. Follow the procedure in [Before working inside your computer](#).
2. Remove the [base cover](#).

About this task

- NOTE:** The fan may become hot during normal operation. Allow sufficient time for the thermal fan to cool before you touch it.
- NOTE:** For maximum cooling of the processor, do not touch the heat-transfer areas on the thermal fan. The oils in your skin can reduce the heat-transfer capability of the thermal grease.

The following image indicates the location of the thermal fan and provides a visual representation of the removal procedure.

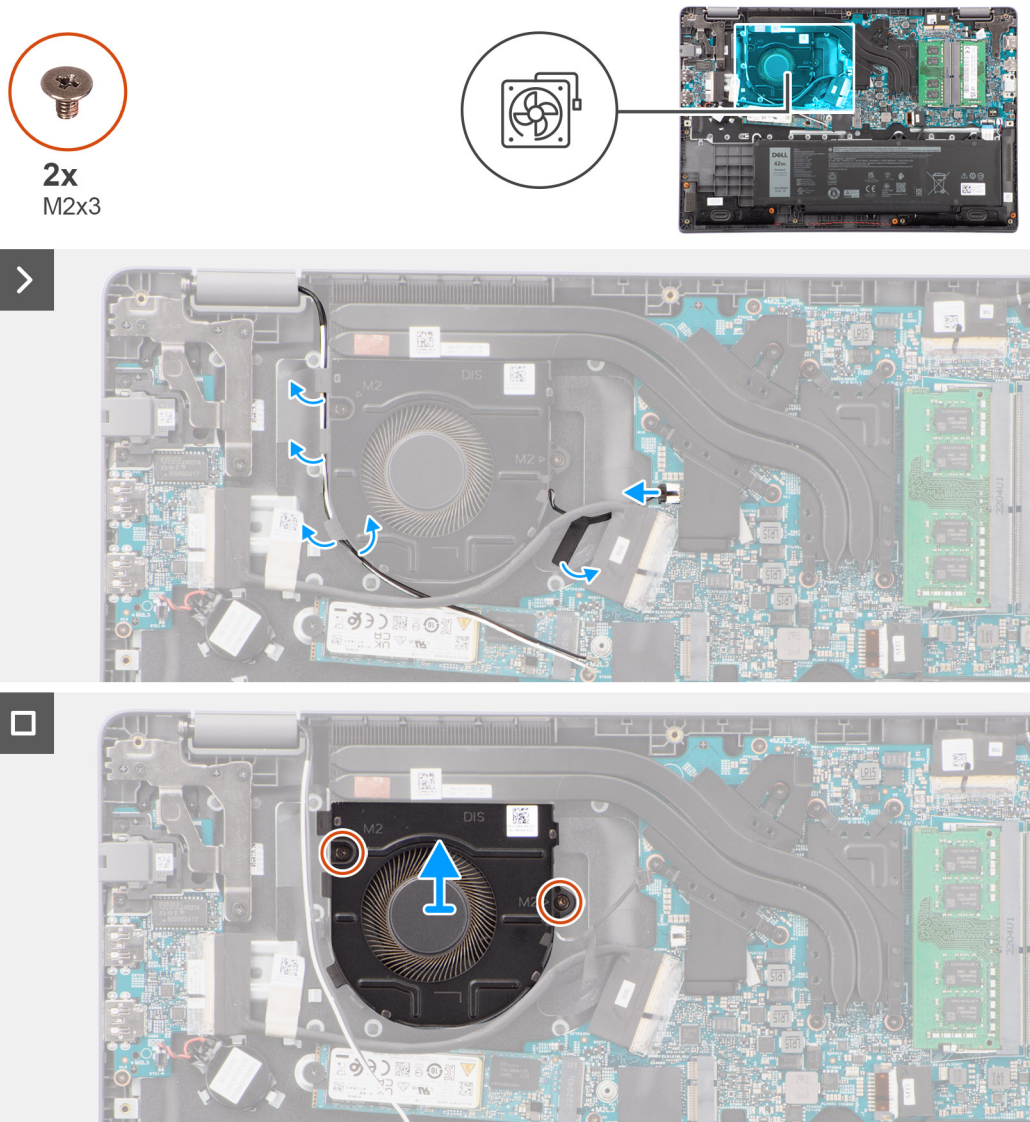

Figure 33. Removing the fan

Steps

1. Disconnect the thermal-fan cable from the connector on the system board.
2. Un route the WLAN antenna cables from the routing guides
3. Remove the two screws (M2x3) that secure the thermal fan to the system board.
4. Lift and remove the thermal fan from the system board.

Installing the fan

Prerequisites

If you are replacing a component, remove the existing component before performing the installation procedure.

About this task

The following image indicates the location of the thermal fan and provides a visual representation of the installation procedure.

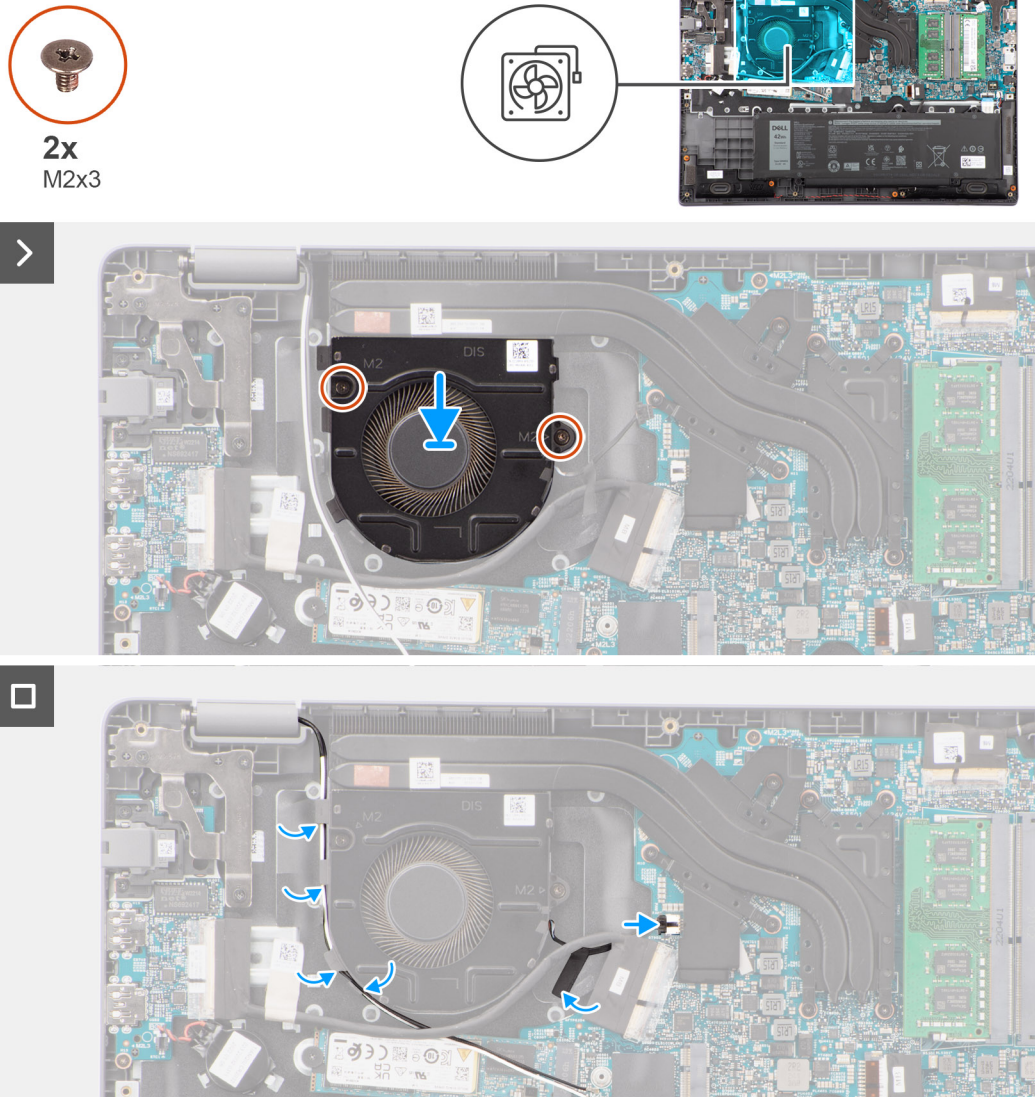

Figure 34. Installing the fan

Steps

1. Place and align the screw holes on the fan with the screw holes on to the system board.
2. Replace the two screws (M2x3) to secure the thermal fan to the system board.
3. Connect the thermal-fan cable to the connector on the system board.

Next steps

1. Install the [base cover](#).
2. Follow the procedure in [After working inside your computer](#).

Touchpad

Removing the touchpad

Prerequisites

1. Follow the procedure in [Before working inside your computer](#).

2. Remove the [base cover](#).
3. Remove the [battery](#).

About this task

The following images indicate the location of the touchpad and provide a visual representation of the removal procedure.

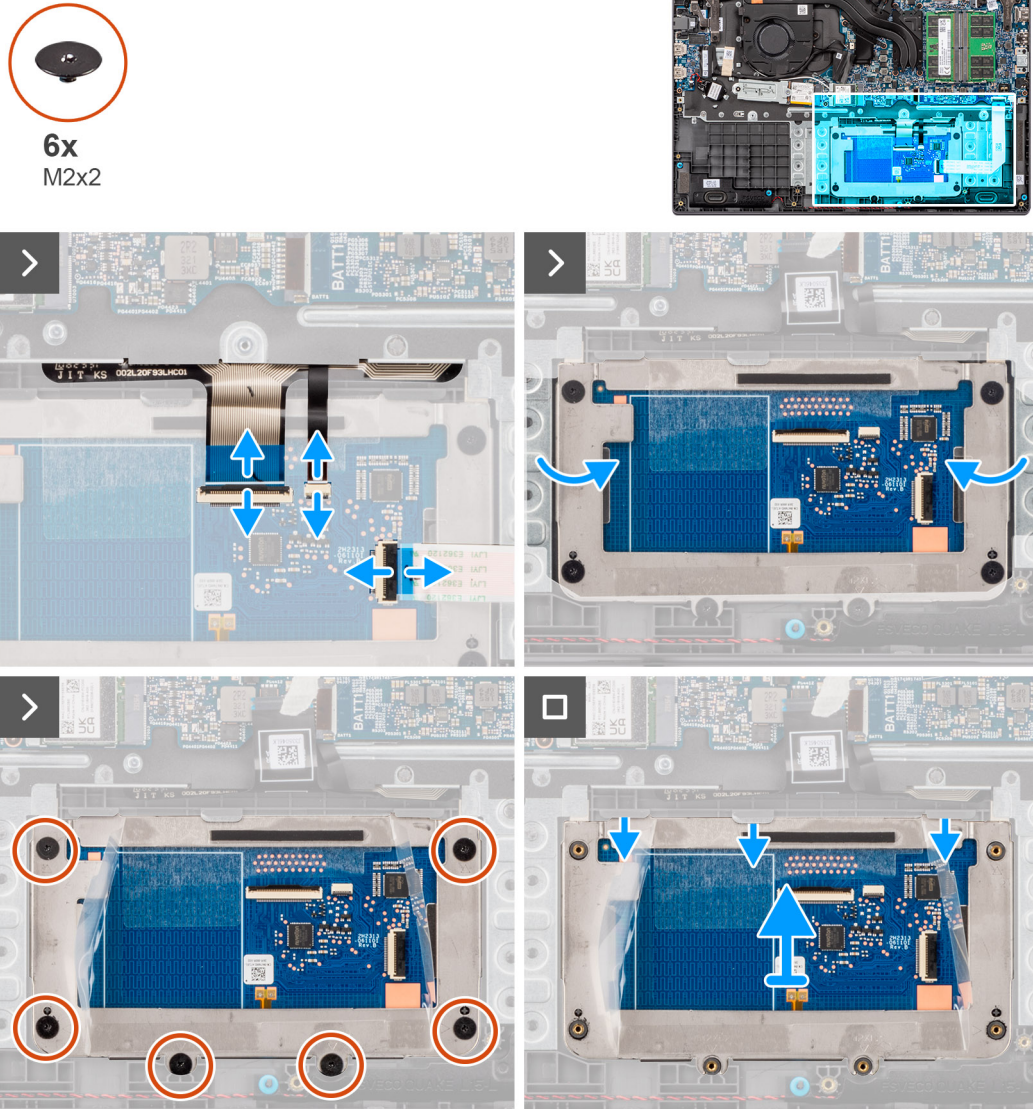

Figure 35. Removing the touchpad

Steps

1. Open the latch and disconnect the touchpad cable from the connector on the system board.
2. Open the latch and disconnect the keyboard cable from the connector on the touchpad module.
3. Open the latch and disconnect the Keyboard-backlight cable from the connector on the touchpad.
4. Partially peel and lift up the adhesive shielding cover from over the touchpad.
5. Remove the six screws (M2x2) that secure the touchpad bracket to the touchpad module.
6. Lift the touchpad module at an angle and slide it out to remove the touchpad module from the palm-rest and keyboard assembly.

Installing the touchpad

Prerequisites

If you are replacing a component, remove the existing component before performing the installation procedure.

About this task

The following images indicate the location of the touchpad and provide a visual representation of the installation procedure.

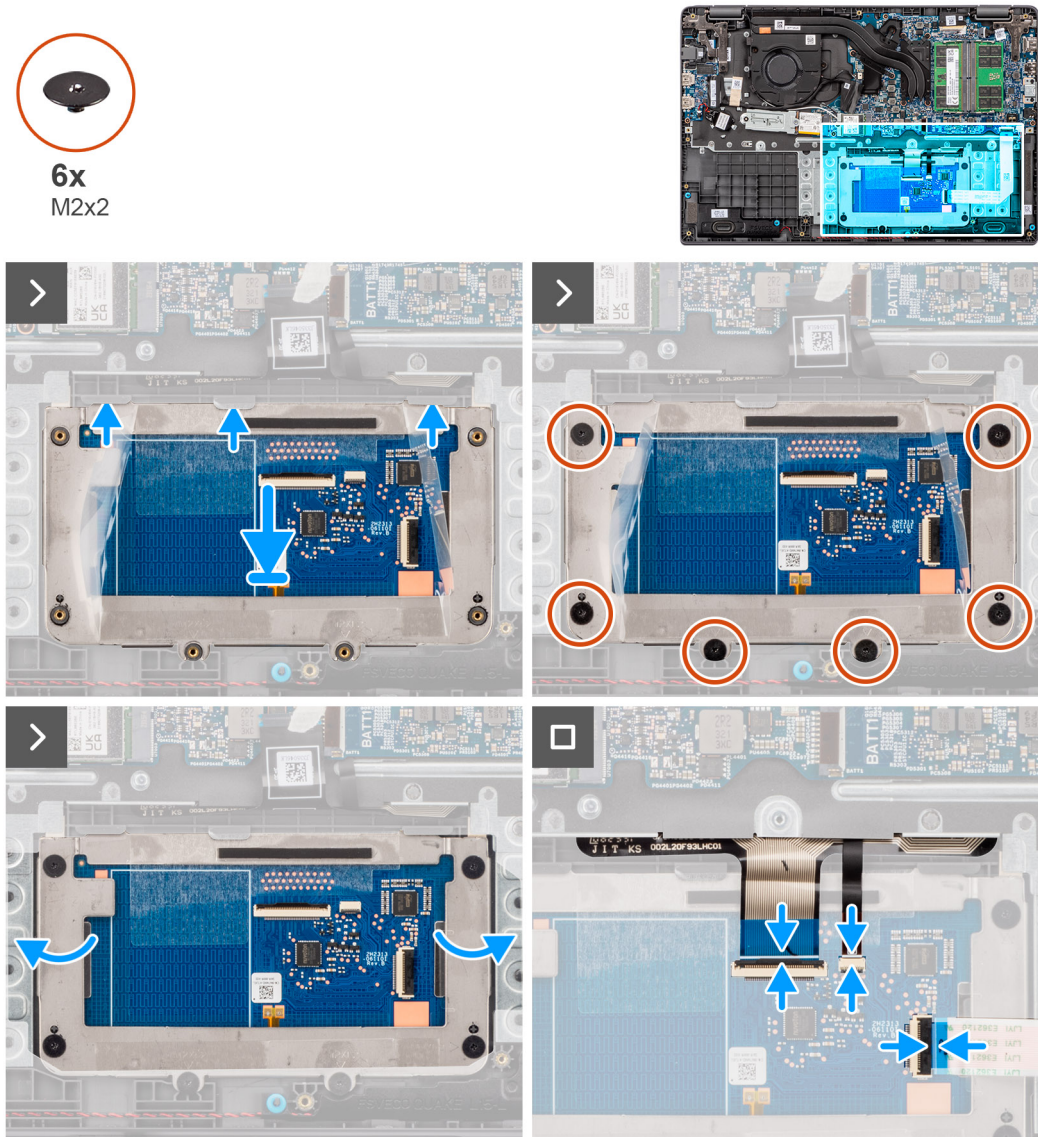

Figure 36. Installing the touchpad

Steps

1. Align and place the touchpad module into the slot on the palm-rest and keyboard assembly.
2. Replace the six screws (M2x2) to secure the touchpad module to the palm-rest and keyboard assembly.
3. Adhere the adhesive shielding cover over the touchpad.
4. Connect the keyboard-backlight cable to the connector on the touchpad module. .
5. Connect the keyboard cable to the connector on the touchpad module close the latch.
6. Connect the touchpad cable to the connector on the system board and close the latch.

Next steps

1. Install the [battery](#).
2. Install the [base cover](#).
3. Follow the procedure in [After working inside your computer](#).

I/O board

Removing the I/O board

Prerequisites

1. Follow the procedure in [Before working inside your computer](#).
2. Remove the [base cover](#).

About this task

The following images indicate the location of the I/O board and provide a visual representation of the removal procedure.

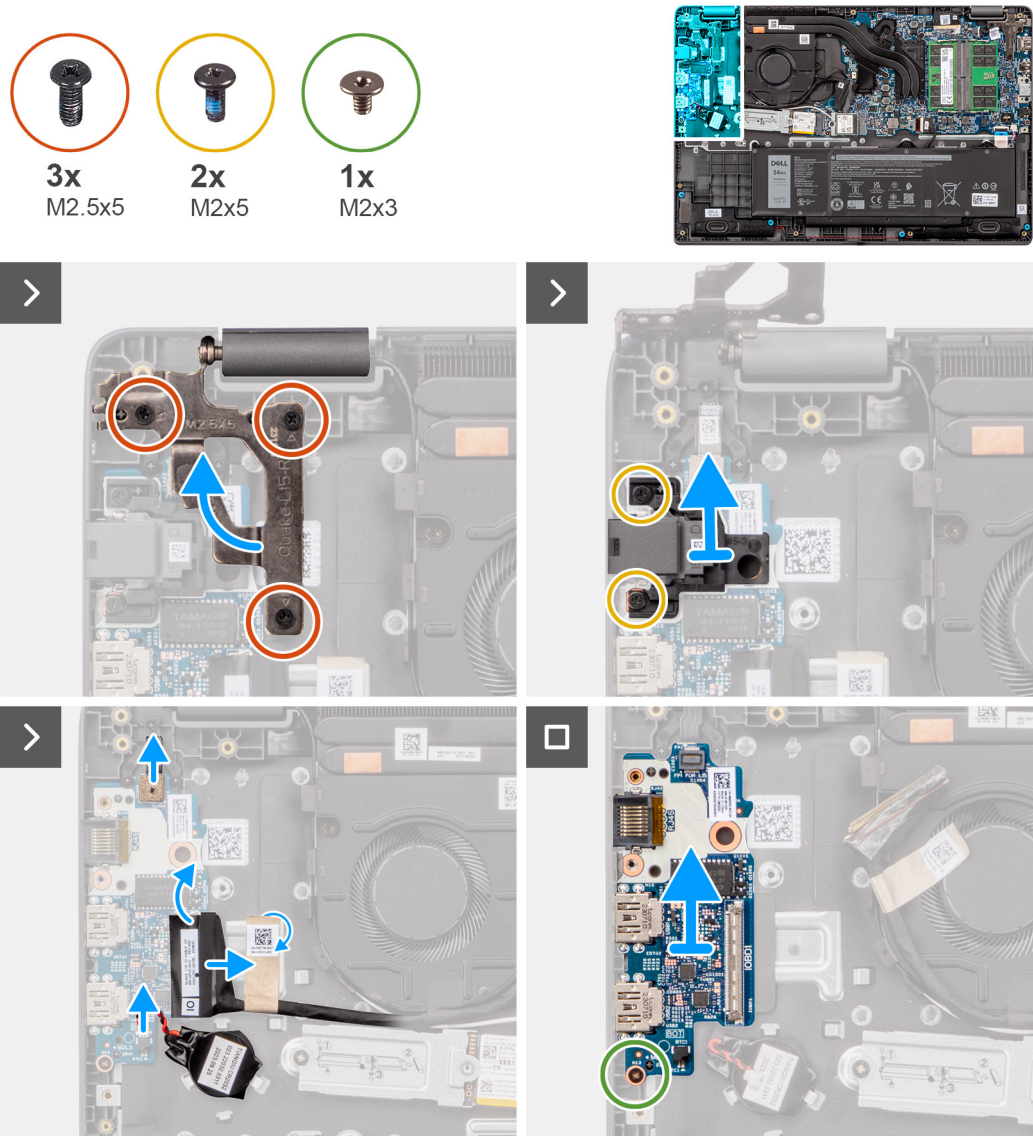

Figure 37. Removing the I/O board

CAUTION: The system has a coin-cell battery that is connected to the I/O board. Disconnecting the I/O board cable resets the BIOS setup program settings to default. Note the BIOS setup program settings before disconnecting the I/O board cable.

Steps

1. Remove the two screws (M2.5x5) that secure the left display hinge to the system.
2. Lift the left display hinge in upward direction away from the system.
3. Remove the two screws (M2x5) that secure the network port.
4. Disconnect the coin-cell battery cable from the connector on the I/O board.
5. Disconnect the fingerprint reader flexible printed circuits from the connector on the I/O board.

NOTE: This procedure applies only to systems shipped with a power button with fingerprint reader installed.

6. Open the latch and disconnect the I/O-board cable from the I/O board.
7. Remove the screw (M2x3) that secures the I/O board to the palm-rest and keyboard assembly.
8. Lift the I/O board off the palm-rest and keyboard assembly.

Installing the I/O board

Prerequisites

If you are replacing a component, remove the existing component before performing the installation procedure.

About this task

The following images indicate the location of the I/O board and provide a visual representation of the installation procedure

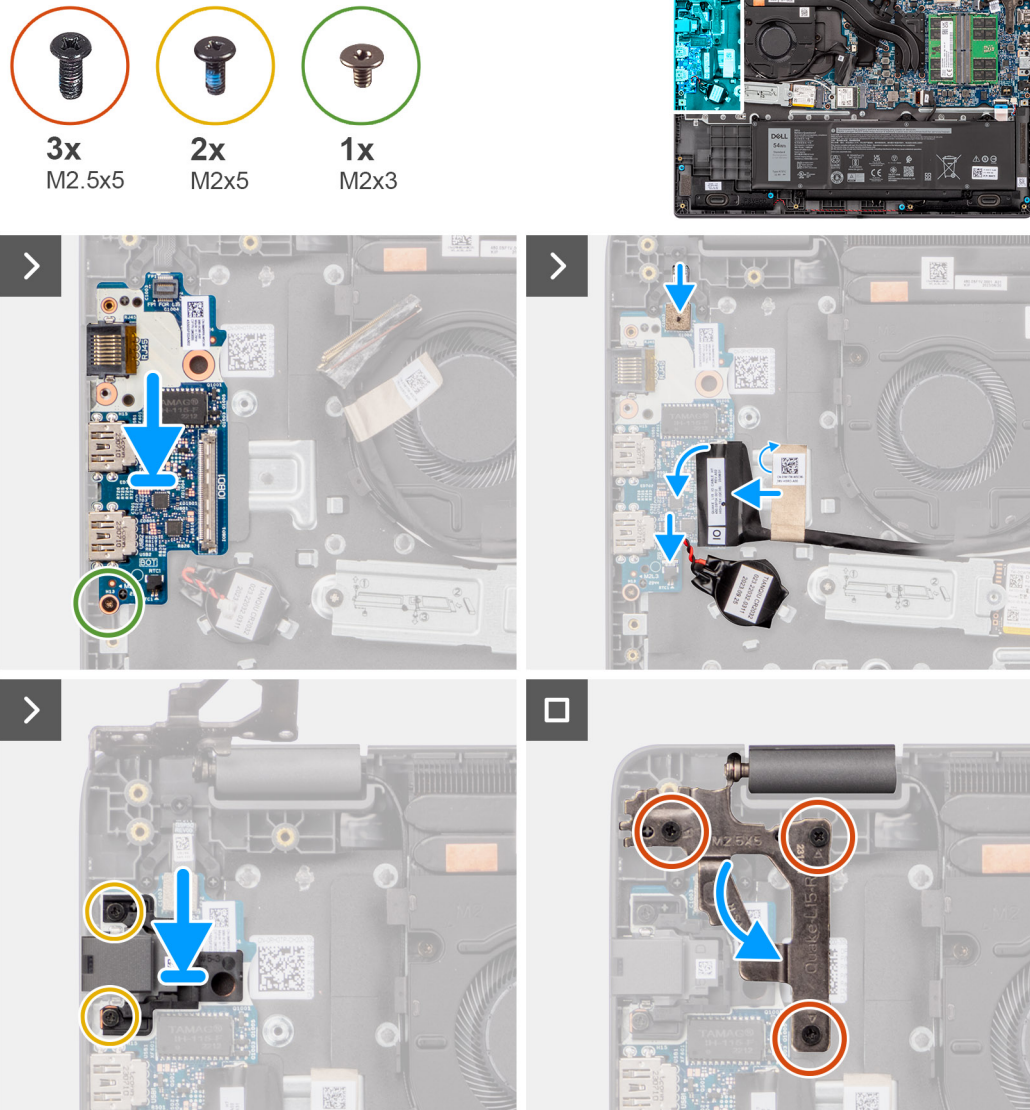

Figure 38. Installing the I/O board

CAUTION: The system has a coin-cell battery that is connected to the I/O board. Disconnecting the I/O board cable resets the BIOS setup program settings to default. Note the BIOS setup program settings before disconnecting the I/O board cable.

Steps

1. Place and align the screw holes on the I/O board with the screw holes on the palm-rest and keyboard assembly.
2. Connect the I/O-board cable to the connector on the I/O board and close its latch.
3. Replace the screw (M2x3) to secure the I/O board to the palm-rest and keyboard assembly.
4. Connect the fingerprint reader flexible printed circuits to the connector on the I/O board securing the fingerprint reader flexible printed circuits.

NOTE: This procedure applies only to systems shipped with a power button with fingerprint reader installed.

5. Connect the coin-cell battery cable to the connector on the I/O board.
6. Replace the two screws (M2x5) to secure the network port.
7. Gently press the left display hinge in downward direction towards the system.
8. Align the screw holes on the left display hinge with the screw holes on the system.

9. Replace the three screws (M2.5x5) to secure the left display hinge to the system.

Next steps

1. Install the [base cover](#).
2. Follow the procedure in [After working inside your computer](#).

Power-button board

Removing the power button

Prerequisites

1. Follow the procedure in [Before working inside your computer](#).
2. Remove the [base cover](#).
3. Remove the [I/O board](#).

About this task

The following images indicate the location of the power button and provide a visual representation of the removal procedure.

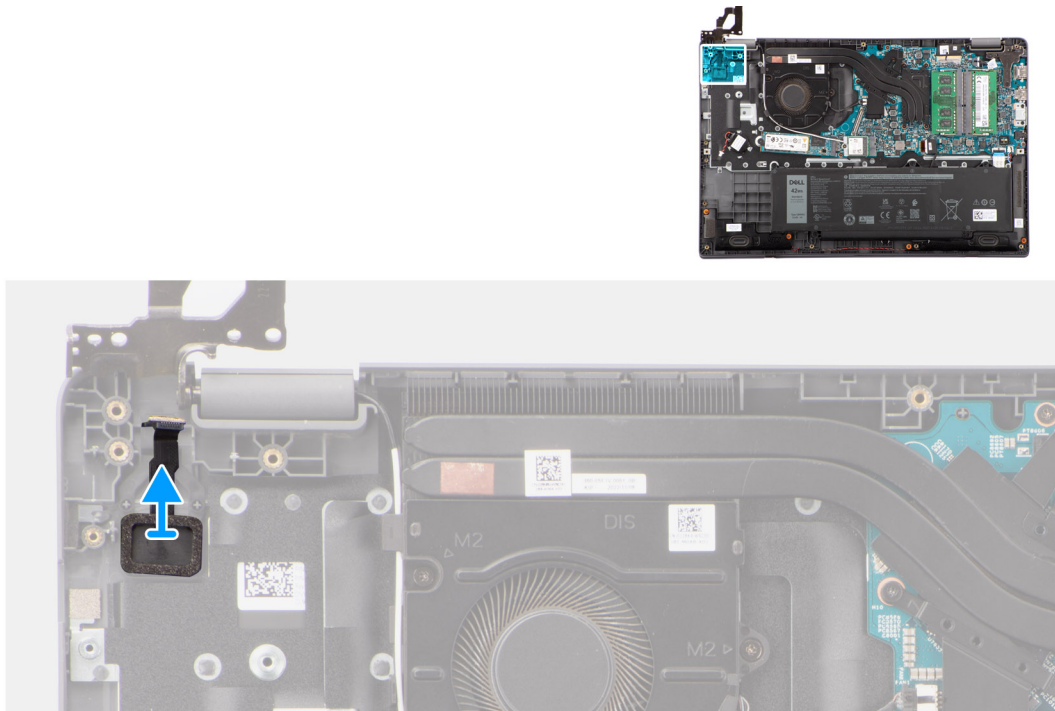

Figure 39. Removing the power button

Steps

Lift to remove the power button from the slot on the palm-rest and keyboard assembly.

Installing the power button

Prerequisites

If you are replacing a component, remove the existing component before performing the installation procedure.

About this task

The following images indicate the location of the power button and provide a visual representation of the installation procedure.

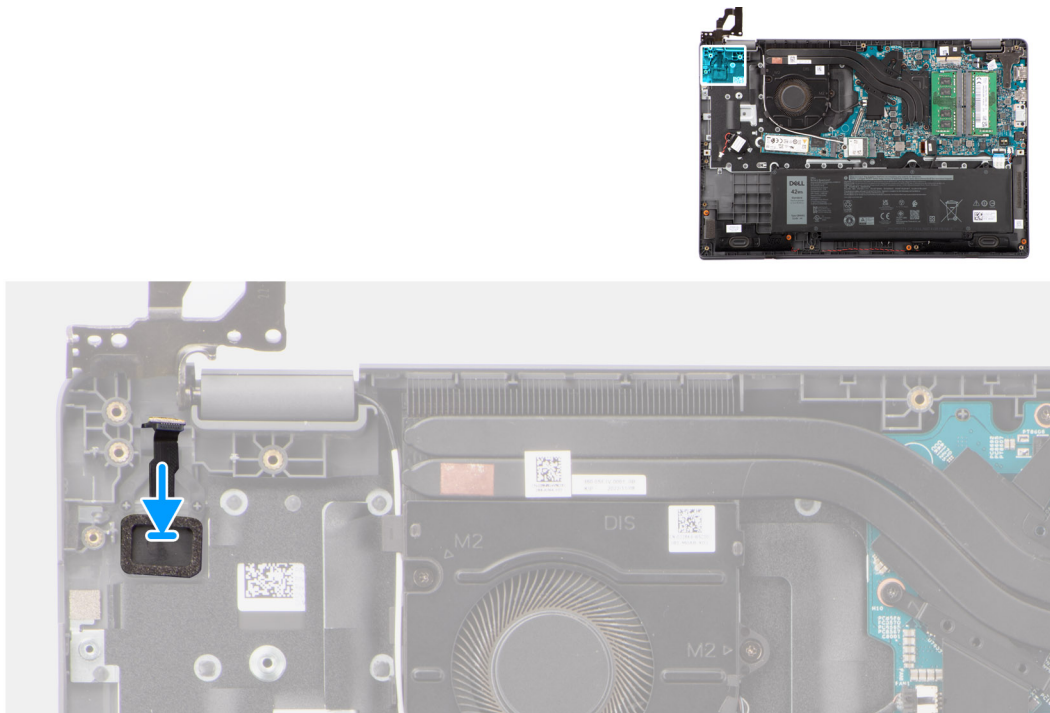

Figure 40. Installing the power button

Steps

1. Align the screw holes on the power button to the screw holes on the palm-rest and keyboard assembly.
2. Replace the two screws (M2x2.5) to secure the power button to the palm-rest and keyboard assembly.

Next steps

1. Install the [I/O board](#).
2. Install the [base cover](#).
3. Follow the procedure in [After working inside your computer](#).

System board

Removing the system board

Prerequisites

1. Follow the procedure in [Before working inside your computer](#).
2. Remove the [base cover](#).
3. Remove the [battery](#).
4. Remove the [M.2 2230 solid-state drive](#)
5. Remove the [wireless card](#).
6. Remove the [fan](#).
7. Remove the [heat sink](#).
8. Remove the [display assembly](#).

About this task

The following image indicates the connectors on your system board.

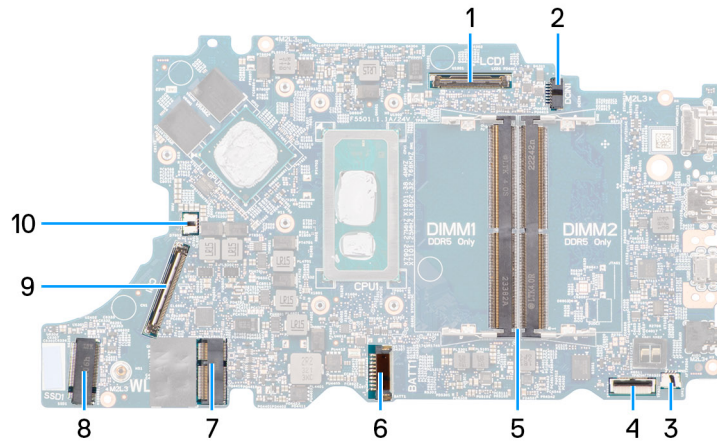

Figure 41. System-board connectors - front

- | | |
|------------------------------|------------------------------------|
| 1. Display-cable connector | 2. DC-in port connector |
| 3. Speaker-cable connector | 4. Touchpad-cable connector |
| 5. Memory-module-connectors | 6. Battery-cable connector |
| 7. WLAN-card connector | 8. M.2 solid-state drive connector |
| 9. I/O-board cable connector | 10. Fan-cable connector |

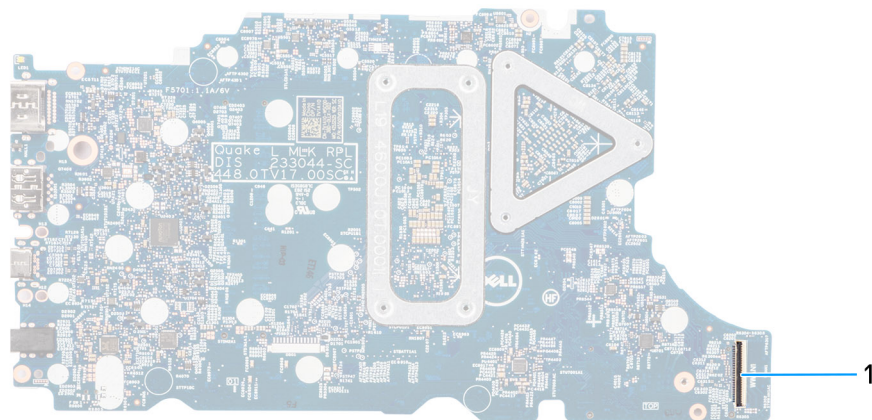
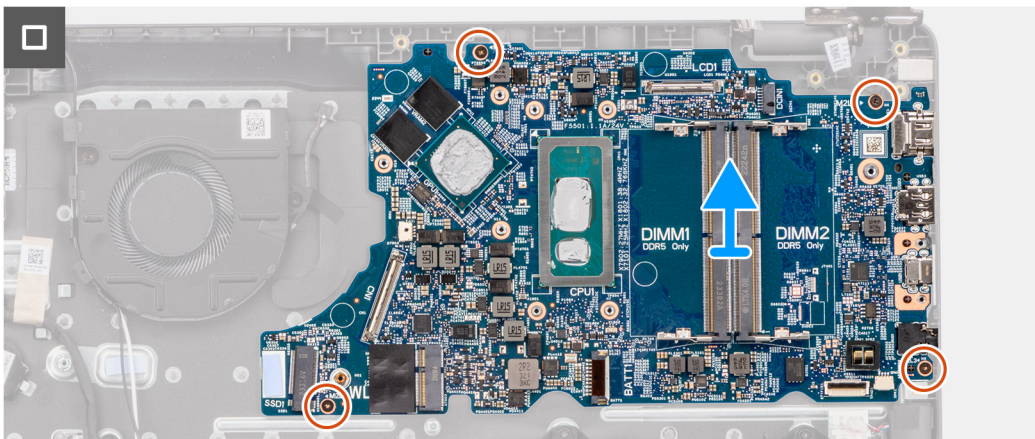
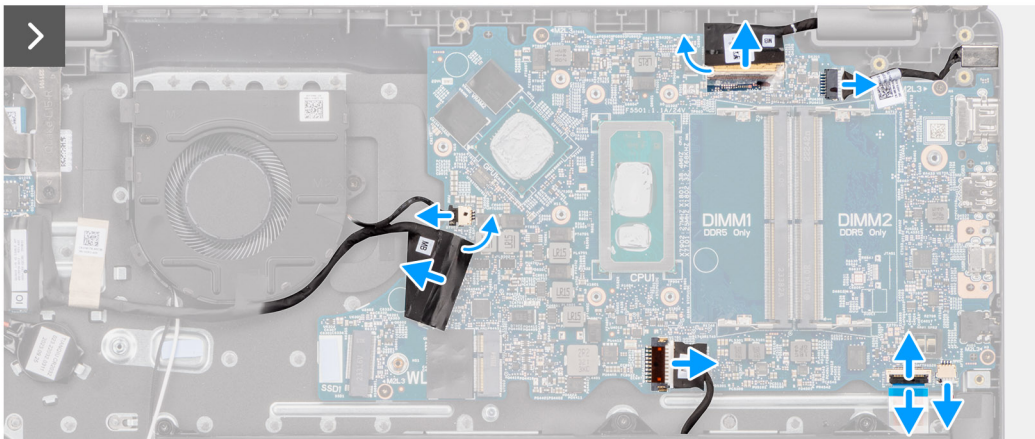
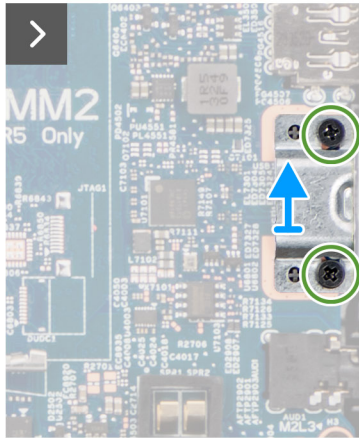
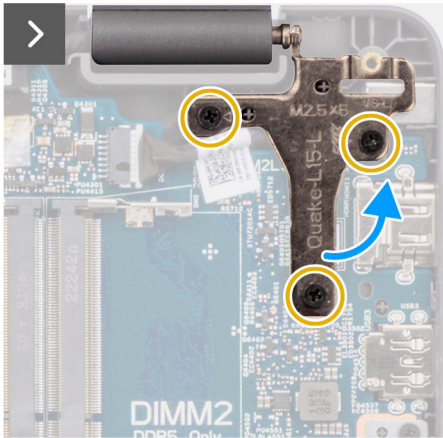
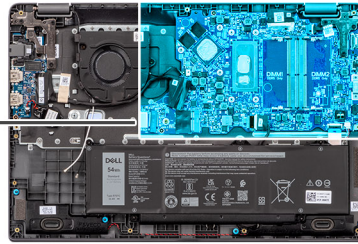

Figure 42. System-board connectors - back

1. WWAN cable connector

The following images indicate the location of the system board and provide a visual representation of the removal procedure.

Figure 43. Removing the System Board



CAUTION: The system has a coin-cell battery that is connected to the I/O board. Disconnecting the I/O board cable resets the BIOS setup program settings to default. Note the BIOS setup program settings before disconnecting the I/O board cable.

Steps

1. Remove the three screws (M2.5x5) that secure the right display hinge to the system board.

2. Remove the two screws (M2x5) that secure the USB type-C bracket to the system board.
3. Disconnect the following cables from the respective connectors on the system board:
 - Touchpad cable
 - I/O board cable
 - Speaker cable
 - Fan cable
 - Display cable
 - Power adapter port cable
4. Remove the four screws (M2x3) that secure the system board to the palm-rest and keyboard assembly.
5. Lift to flip the system board and disconnect the WWAN FPC cable.
6. Lift and remove the system board from the palm-rest and keyboard assembly.

Installing the system board

Prerequisites

If you are replacing a component, remove the existing component before performing the installation procedure.

About this task

The following images indicate the location of the system board and provide a visual representation of the installation procedure.

Figure 44. Installing the system board

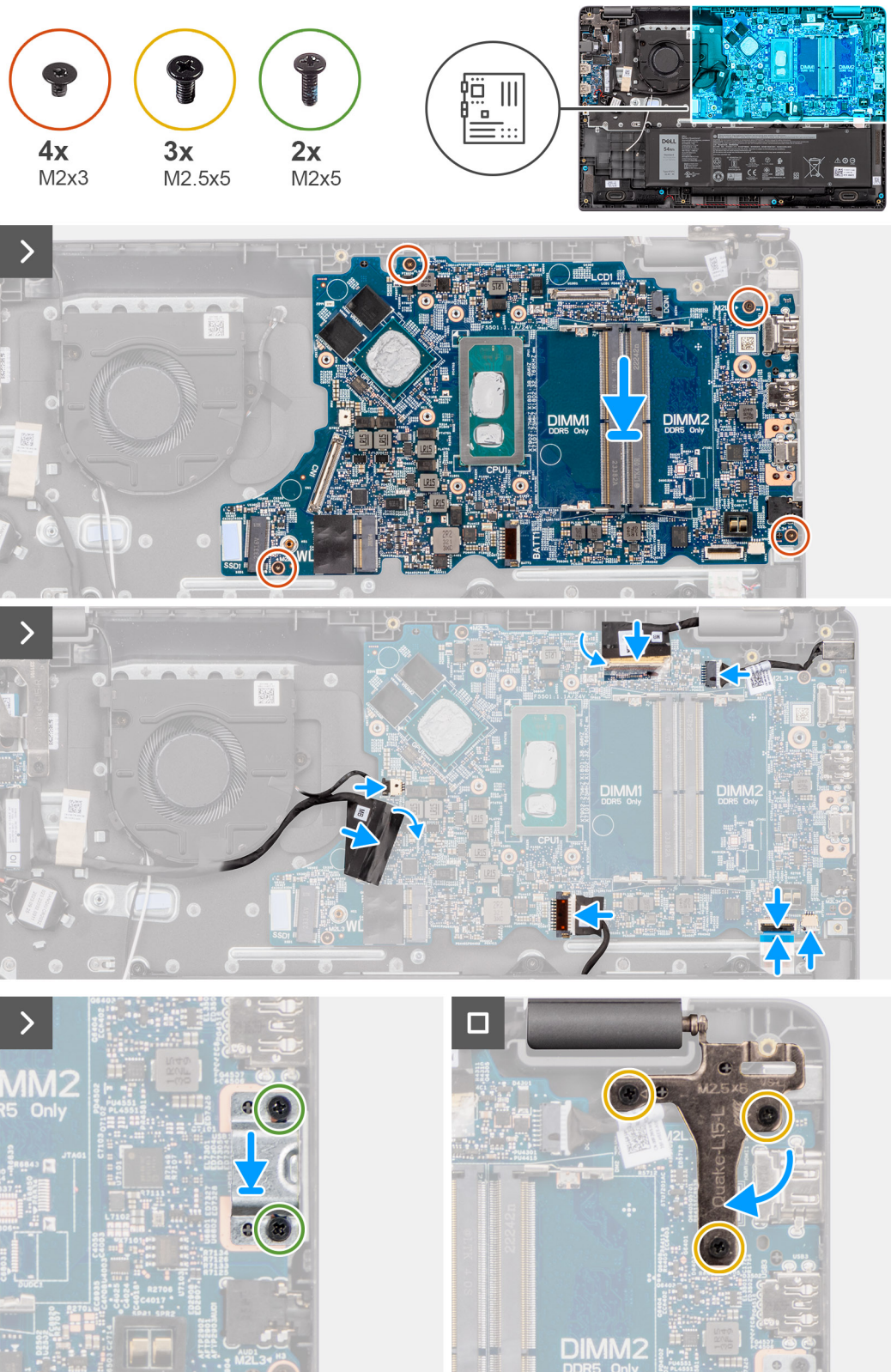

Figure 45. Installing the system board

CAUTION: The system has a coin-cell battery that is connected to the I/O board. Disconnecting the I/O board cable resets the BIOS setup program settings to default. Note the BIOS setup program settings before disconnecting the I/O board cable.

Steps

1. Connect the WWAN FPC cable to its connector and flip the system board.
2. Align the screw holes on the system board with the screw holes on the palm-rest and keyboard assembly.
3. Replace the four screws (M2x3) to secure the system board to the palm-rest and keyboard assembly.
4. Connect the following cables to the respective connectors on the system board:
 - Touchpad cable
 - I/O board cable
 - Speaker cable
 - Fan cable
 - Display cable
 - Power adapter port cable
5. Replace the screw (M2x5) to secure the USB type-C bracket to the system board.
6. Replace the three screws (M2.5x5) to secure the right display hinge to the system board.

Next steps

1. Install the [display assembly](#).
2. Install the [heat-sink](#).
3. Install the [fan](#).
4. Install the [wireless card](#).
5. Install the [M.2 2230 solid-state drive](#)
6. Install the [battery](#).
7. Install the [base cover](#).
8. Follow the procedure in [After working inside your computer](#).

Palm-rest and keyboard assembly

Removing the palm-rest and keyboard assembly

Prerequisites

1. Follow the procedure in [Before working inside your computer](#).
2. Remove the [base cover](#).
3. Remove the [battery](#).
4. Remove the [M.2 2230 solid-state drive](#)
5. Remove the [wireless card](#).
6. Remove the [coin-cell battery](#).
7. Remove the [display assembly](#).
8. Remove the [I/O board](#).
9. Remove the [power button](#)
10. Remove the [speakers](#).
11. Remove the [touchpad](#).
12. Remove the [system board](#).

NOTE: The system board can be removed with the heat-sink that is attached to it in order to simplify the procedure and preserve the thermal bond between the system board and the heat-sink.

13. Remove the [power-adapter port](#).
14. Remove the [fan](#).
15. Remove the [heat-sink](#).

About this task

NOTE: The palm-rest assembly cannot be further disassembled once all the pre-removal parts procedures are completed. If the keyboard is malfunctioning and is required to be replaced, replace the entire palm-rest assembly.

The image below shows the palm-rest assembly after the pre-removal parts procedures have been performed, after performing the steps mentioned in the prerequisites, you are left with the palm-rest assembly.

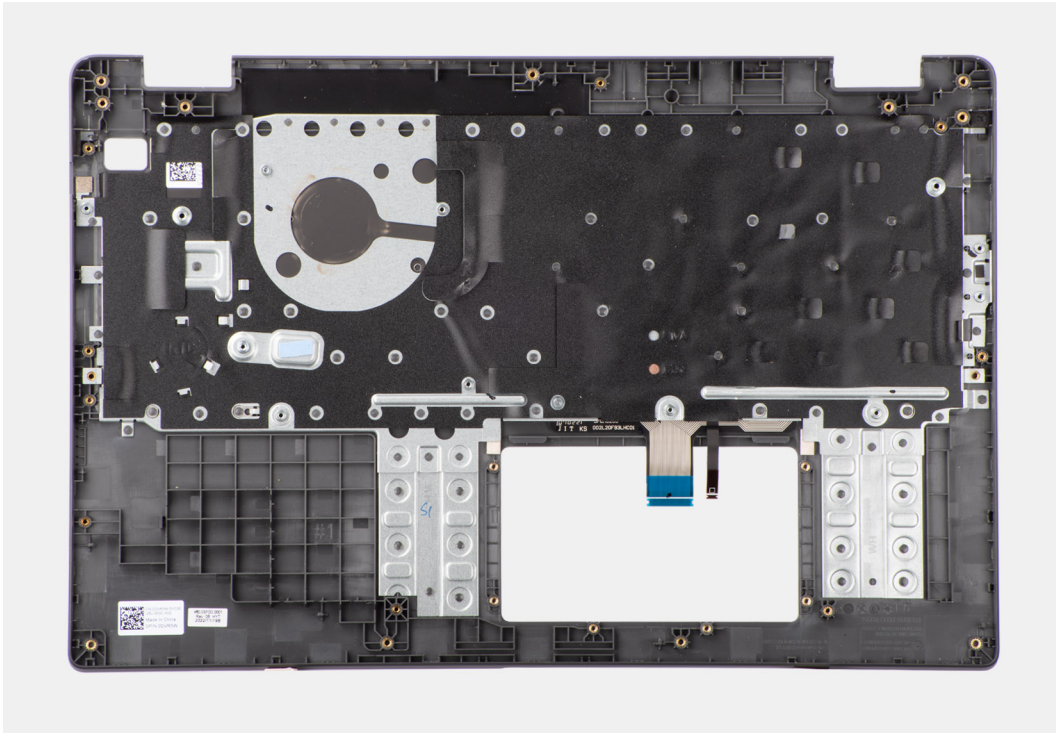

Figure 46. Removing the palm-rest and keyboard assembly

Installing the palm-rest and keyboard assembly

Prerequisites

If you are replacing a component, remove the existing component before performing the installation procedure.

About this task

The following image shows the palm-rest and keyboard assembly.

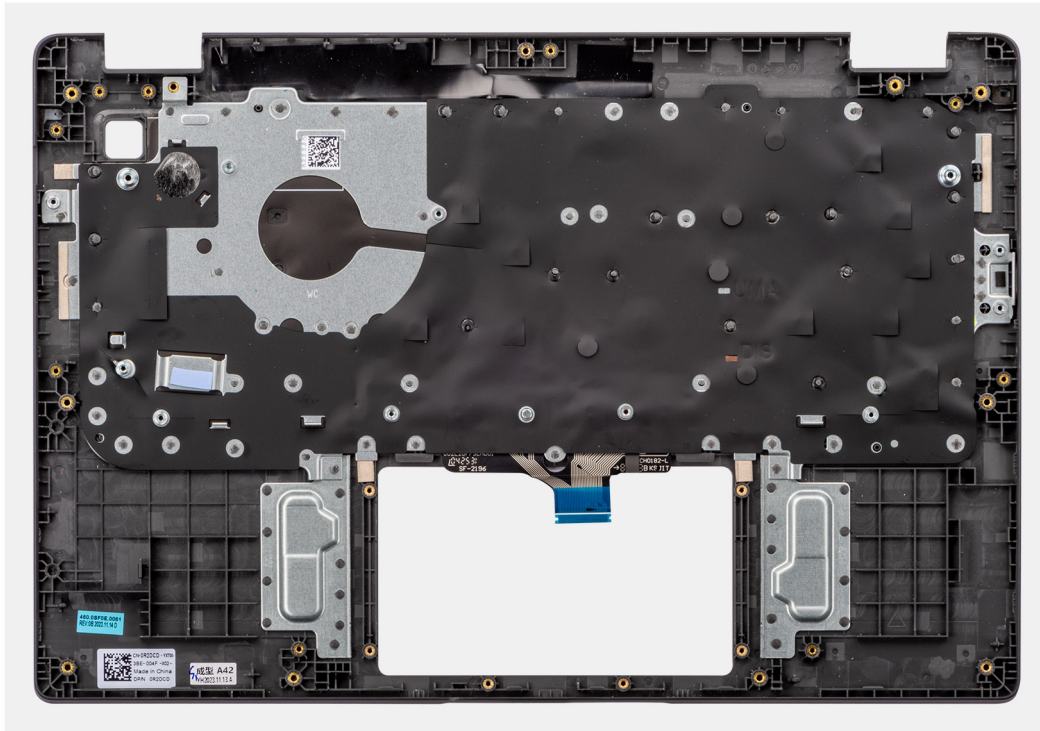
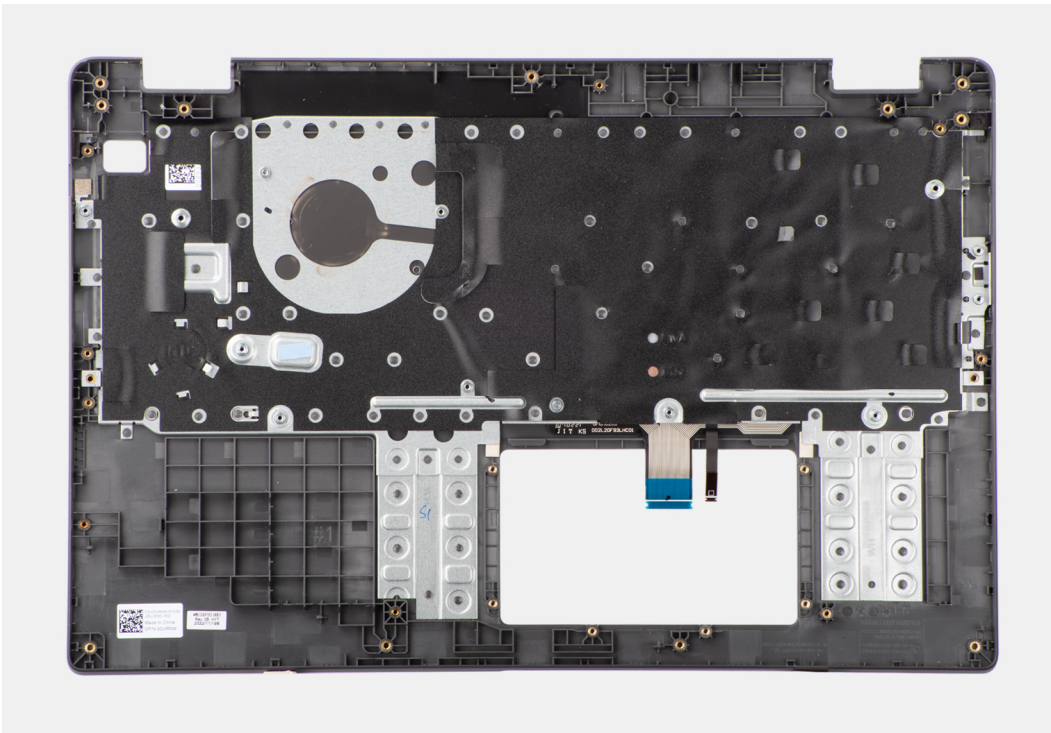

Figure 47. Installing the palm-rest and keyboard assembly



Steps

Place the palm-rest and keyboard assembly on a flat surface.

Next steps

1. Install the [power-adaptor port](#).
2. Install the [system board](#).

NOTE: The system board can be installed with the thermal heat-sink attached to it in order to simplify the procedure and preserve the thermal bond between the system board and the thermal heat-sink.

3. Install the [touchpad](#).
4. Install the [speakers](#).
5. Install the [power button](#).
6. Install the [I/O board](#).
7. Install the [display assembly](#).
8. Install the [coin-cell battery](#).
9. Install the [heat-sink](#).
10. Install the [fan](#).
11. Install the [wireless card](#).
12. Install the [M.2 2230 solid-state drive](#)
13. Install the [battery](#).
14. Install the [base cover](#).
15. Follow the procedure in [After working inside your computer](#).

Display assembly

Removing the display assembly

Prerequisites

1. Follow the procedure in [Before working inside your computer](#).
2. Remove the [base cover](#).
3. Remove the [wireless card](#).

About this task

NOTE: The display assembly removal procedure is the same for both clamshell and 2-in-1 convertible chassis.

The following images indicate the location of the display assembly and provide a visual representation of the removal procedure.

Figure 48. Removing the display assembly

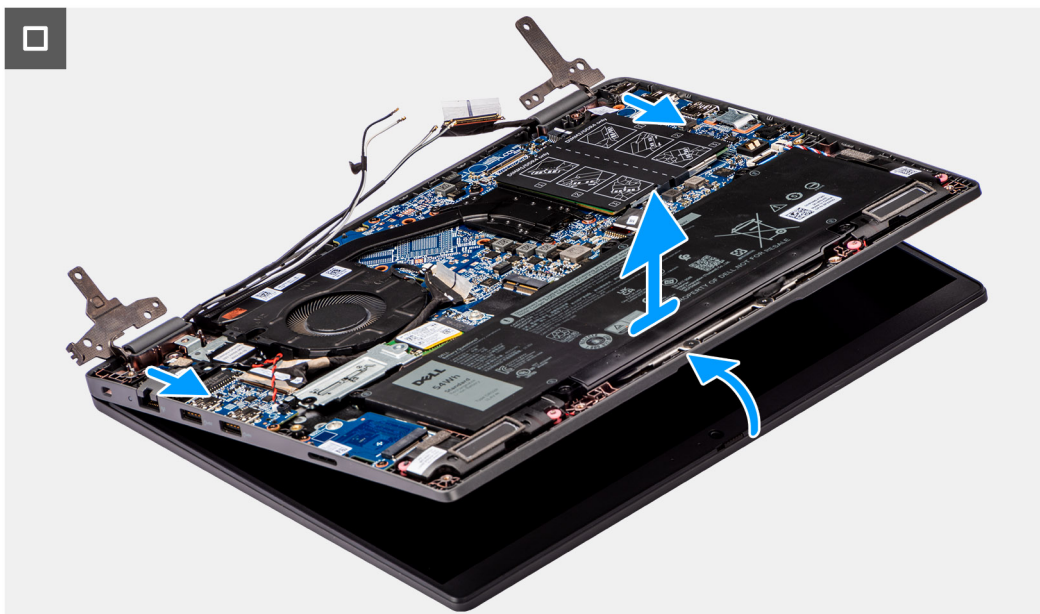

Figure 49. Removing the display assembly



6x
M2.5x5

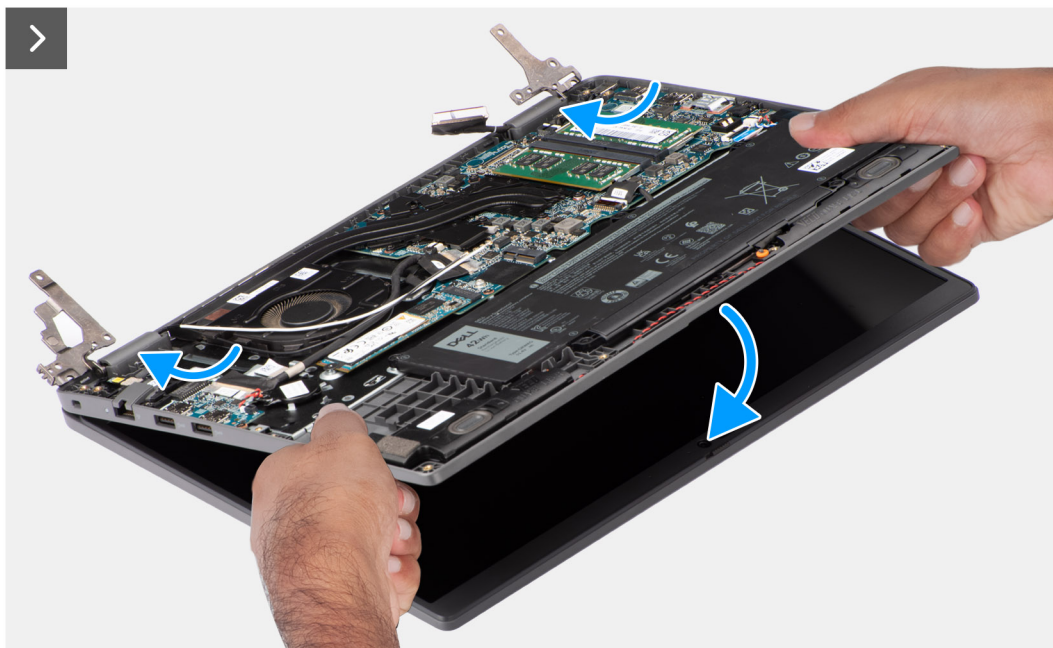
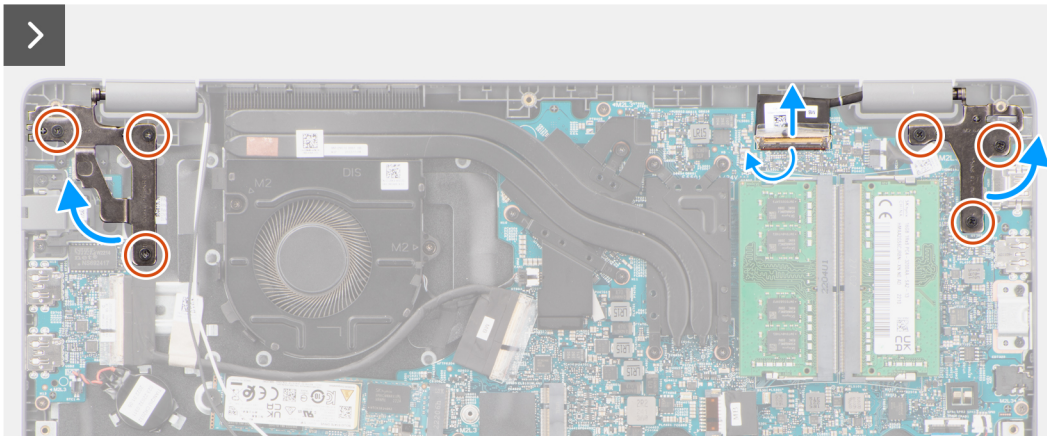
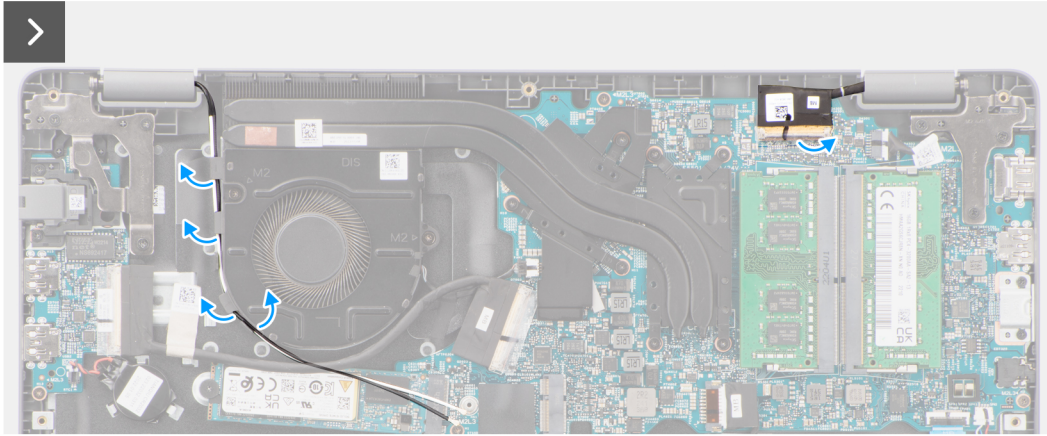
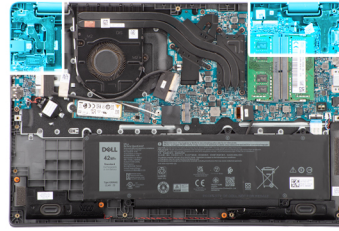

Figure 50. Removing the display assembly

Steps

1. Place the system on a flat surface such that the palm-rest and keyboard assembly lay flat on the surface.
2. Peel the adhesive tape that secures the display cable and remove antenna cable from routing guides.
3. Open the latch and disconnect the display cable from the connector on the system board.
4. Unroute the WLAN antenna cables from the routing guides on the fan.
5. Remove the six screws (M2.5x5) that secure the display hinges to the palm-rest and keyboard assembly.
6. Lift the left and right hinges in upward direction, away from the system.
7. Lift the palm-rest and keyboard assembly at an angle to free it from the hinges and remove it from the display assembly.

Installing the display assembly

Prerequisites

If you are replacing a component, remove the existing component before performing the installation procedure.

About this task

NOTE: The display assembly installation procedure is the same for both clamshell and 2-in-1 convertible chassis.

NOTE: Ensure that the hinges are opened to the maximum before replacing the display assembly on the palm-rest and keyboard assembly.

The following images indicate the location of the display assembly and provide a visual representation of the installation procedure.

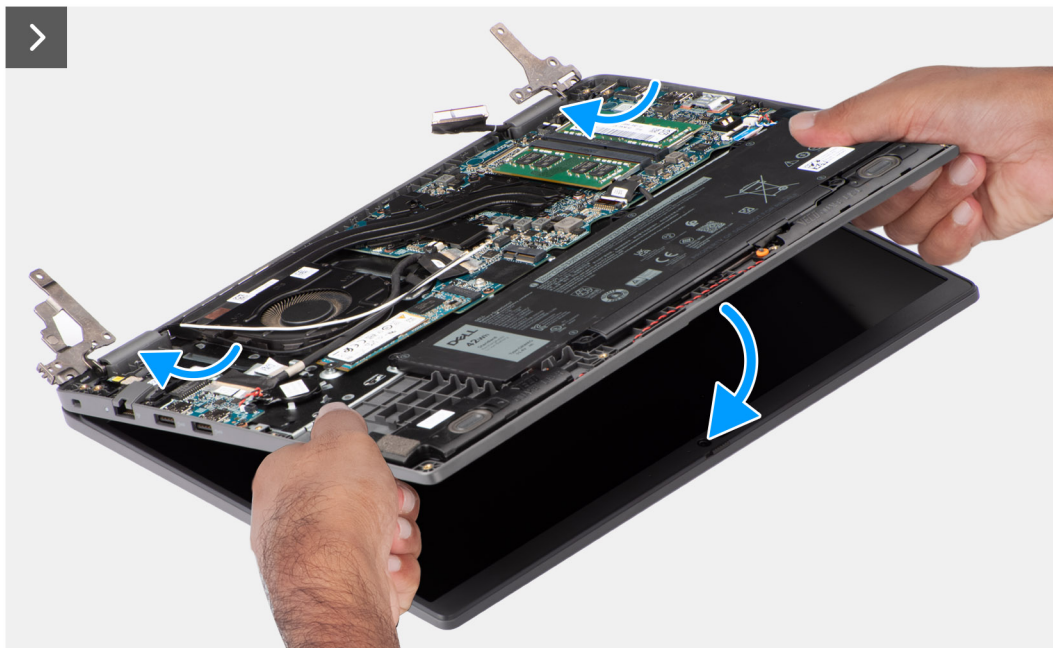

Figure 51. Installing the display assembly



6x
M2.5x5

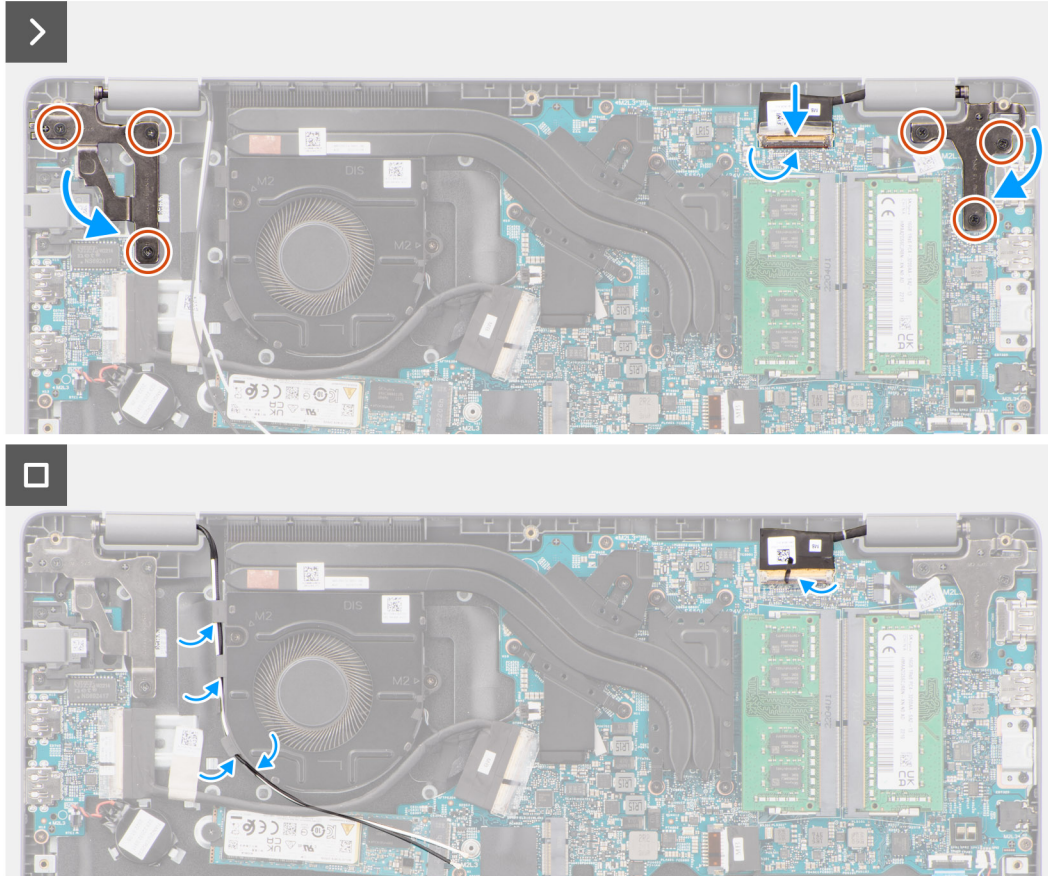
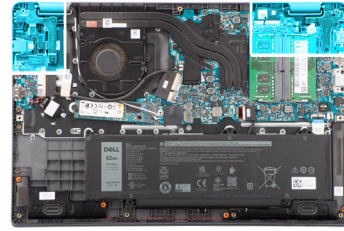

Figure 52. Installing the display assembly

Steps

1. Place the display assembly on a flat surface.
2. Slide the display assembly at an angle and place the system chassis under the hinges of the display assembly.
3. Gently press down on the display hinges to align the screw holes on the display hinges with the screw holes on the palm-rest and keyboard assembly.
4. Replace the six screws (M2.5x5) to secure the display hinges to the palm-rest and keyboard assembly.
5. Route the WLAN antenna cables over the routing guides on the fan.
6. Connect the display cable to its connector on the system board.
7. Adhere the adhesive tape to secure the display cable.

Next steps

1. Install the [wireless card](#).
2. Install the [base cover](#).
3. Follow the procedure in [After working inside your computer](#).

Display bezel

Removing the display bezel

Prerequisites

1. Follow the procedure in [Before working inside your computer](#).
2. Remove the [base cover](#).
3. Remove the [display assembly](#).

About this task

The following image shows the display bezel and provide a visual representation of the removal procedure.

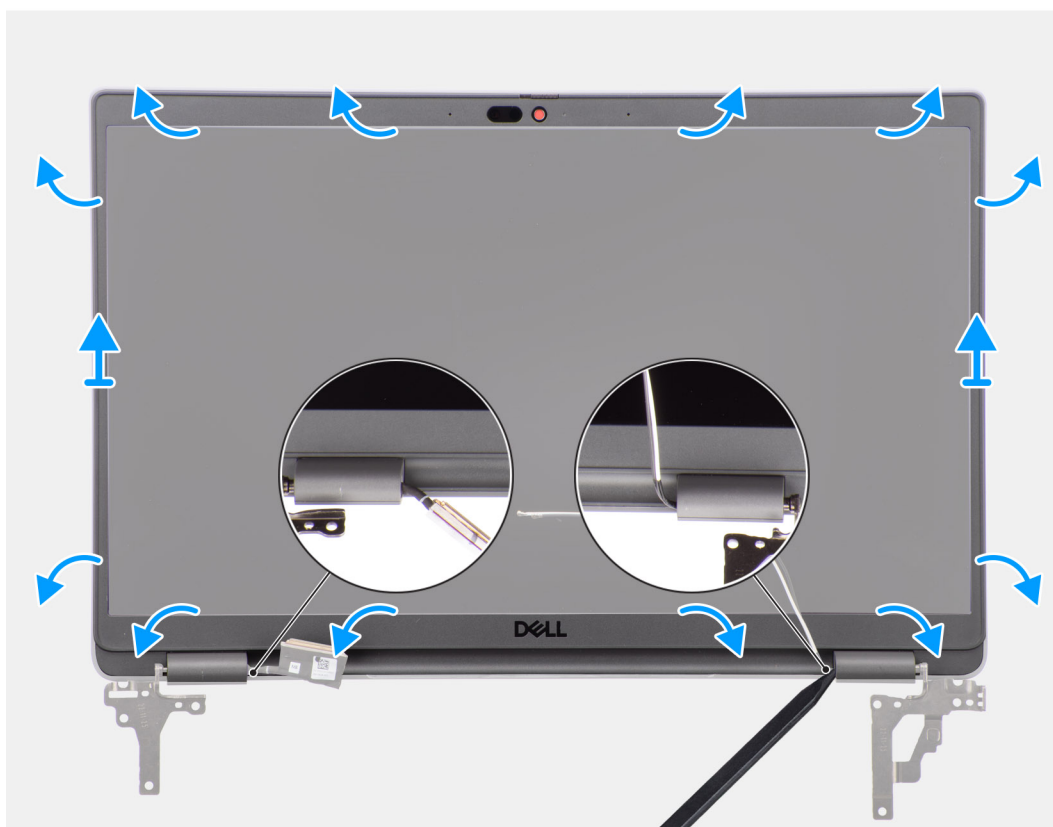

Figure 53. Removing the display bezel

Steps

i **NOTE:** The display bezel is adhered to the display panel with adhesive. Insert a plastic scribe into the recesses near both hinge caps to start the prying process to release the display bezel. Pry along the outside edge of the display bezel and work your way around the entire display bezel until the display bezel is separated from the display cover.

△ **CAUTION:** Carefully pry and remove the display bezel to minimize the risk of display panel damages.

1. Using a plastic scribe, pry open the recesses near the left and right hinges on the bottom edge of the display bezel.
2. Carefully work your way around the edges of the display bezel to release it from the display back cover.
3. Lift the display bezel from the display assembly.

i **NOTE:** The display bezel is a consumable part and should be replaced with a new display bezel anytime it is removed from the system.

Installing the display bezel

Prerequisites

If you are replacing a component, remove the existing component before performing the installation procedure.

About this task

The following image indicates the location of the display bezel and provides a visual representation of the installation procedure.

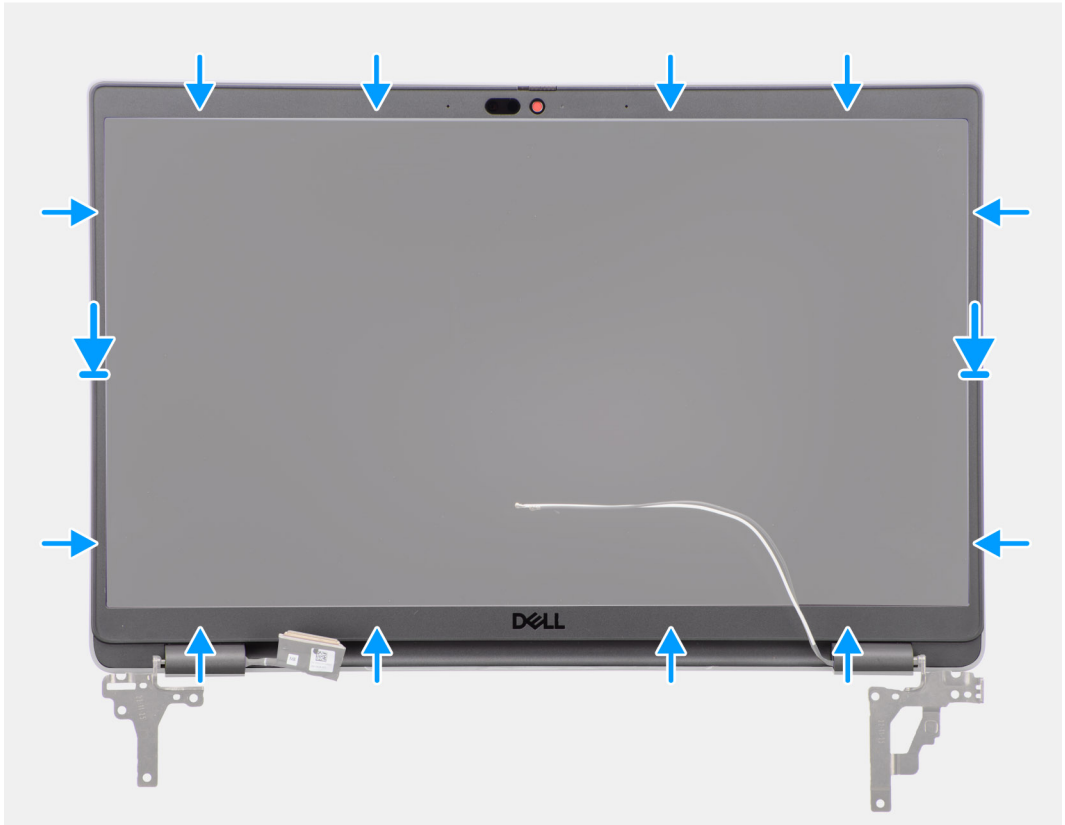

Figure 54. Installing the display bezel

Steps

NOTE: While installing the replacement display bezel for the models that are shipped with a camera, carefully peel off the piece of tape that is used to secure the camera shutter to the replacement display bezel.

CAUTION: The tape covering the camera on the replacement display bezel must be peeled carefully. An abrupt peeling may remove the camera shutter from the display bezel and damage the camera shutter.

1. Align and place the display bezel on the display assembly.
2. Gently snap the display bezel into place.

Next steps

1. Install the [display assembly](#).
2. Install the [base cover](#).
3. Follow the procedure in [After working inside your computer](#).

Display panel

Removing the display panel

Prerequisites

1. Follow the procedure in [Before working inside your computer](#).
2. Remove the [base cover](#).
3. Remove the [display assembly](#).
4. Remove the [display bezel](#).

About this task

The following images indicate the location of the display panel and provide a visual representation of the removal procedure.

Figure 55. Removing the display panel



Figure 56. Removing the display panel



Figure 57. Removing the display panel



Figure 58. Removing the display panel



Figure 59. Removing the display panel



Figure 60. Removing the display panel

Steps

NOTE: The display panel is preassembled with the display brackets as a single service part. Do not pull the Stretch Release (SR) tapes and separate the brackets from the display panel.



1. Remove the six (M2.5x2.5) screws that secures the left and right hinges to the display back cover.

NOTE: While removing the display panel, disengage the display panel tabs from the display cover before flipping it over

2. Lift up the lower portion of the LCD panel and slide downwards to access the display cable.
3. Peel the conductive tape on the display cable connector.
4. Open the latch and disconnect the cable from the connector on the display panel.
5. Lift the display panel away from the display back cover.

Installing the display panel

Prerequisites

If you are replacing a component, remove the existing component before performing the installation procedure.

About this task

The following images indicate the location of the display panel and provides a visual representation of the installation procedure.



Figure 61. Installing the display panel



Figure 62. Installing the display panel



Figure 63. Installing the display panel



Figure 64. Installing the display panel



6x
M2.5x2.5



Figure 65. Installing the display panel

Steps

1. Place the display panel on flat and clean surface.
2. Connect the display cable to the connector on the display panel and close the latch.
3. Adhere the conductive tape to secure the display cable to the display panel.
4. Insert the display panel tabs into the slots on the display cover.
5. Replace the six (M2.5x2.5) screws to secure the display panel to the display back cover.

Next steps

1. Install the [display bezel](#).
2. Install the [display assembly](#).
3. Install the [base cover](#).
4. Follow the procedure in [After working inside your computer](#).

Camera

Removing the camera

Prerequisites

1. Follow the procedure in [Before working inside your computer](#).
2. Remove the [base cover](#).
3. Remove the [display assembly](#).
4. Remove the [display bezel](#).
5. Remove the [display panel](#).

About this task

The following images indicate the location of the camera and provide a visual representation of the removal procedure.

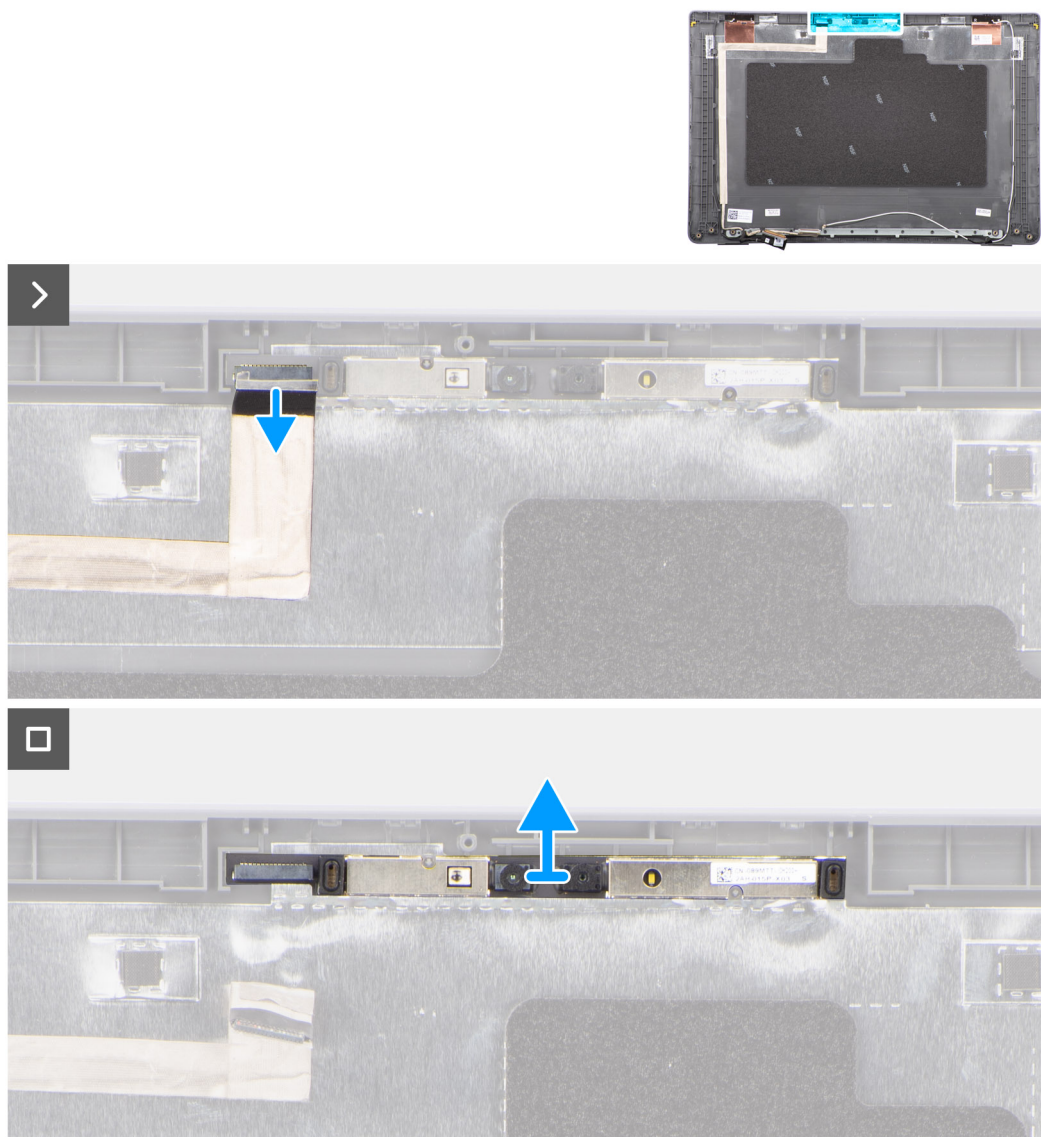

Figure 66. Removing the camera

Steps

1. Disconnect the camera cable from the camera module.

2. Lift to remove the camera module from the display back cover.

Installing the camera

Prerequisites

If you are replacing a component, remove the existing component before performing the installation procedure.

About this task

The following images indicate the location of the display panel and provides a visual representation of the installation procedure.

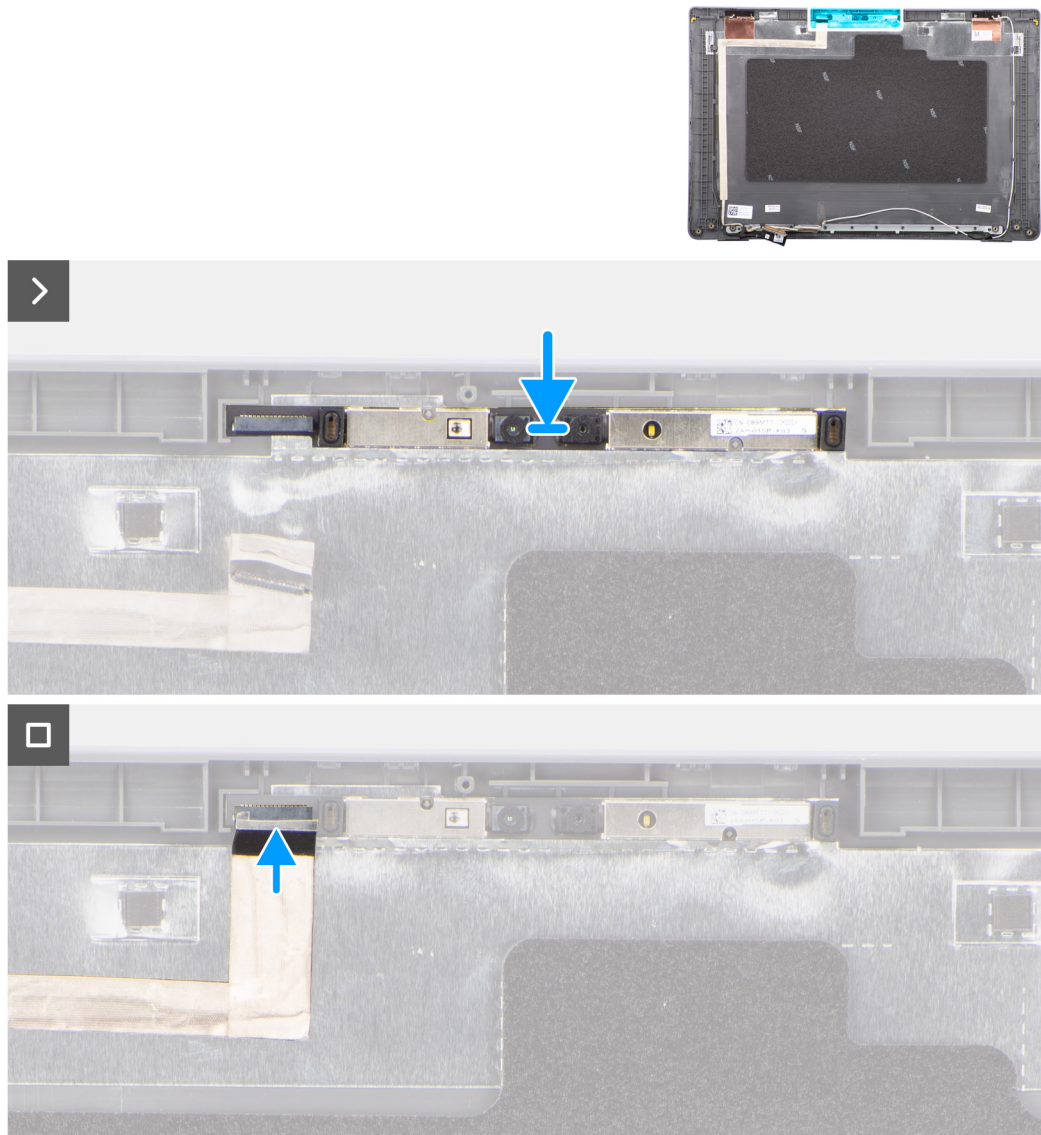

Figure 67. Installing the camera

Steps

1. Align and replace the camera module on the display back cover.
2. Connect the camera cable to the camera module.

Next steps

1. Install the [display panel](#).
2. Install the [display bezel](#).

3. Install the [display assembly](#).
4. Install the [base cover](#).
5. Follow the procedure in [After working inside your computer](#).

eDP cable

Removing the eDP cable

Prerequisites

1. Follow the procedure in [Before working inside your computer](#).
2. Remove the [base cover](#).
3. Remove the [display assembly](#).
4. Remove the [display bezel](#).
5. Remove the [display panel](#).
6. Remove the [camera](#).

About this task

The following image indicates the location of the eDP cable and provide a visual representation of the removal procedure.

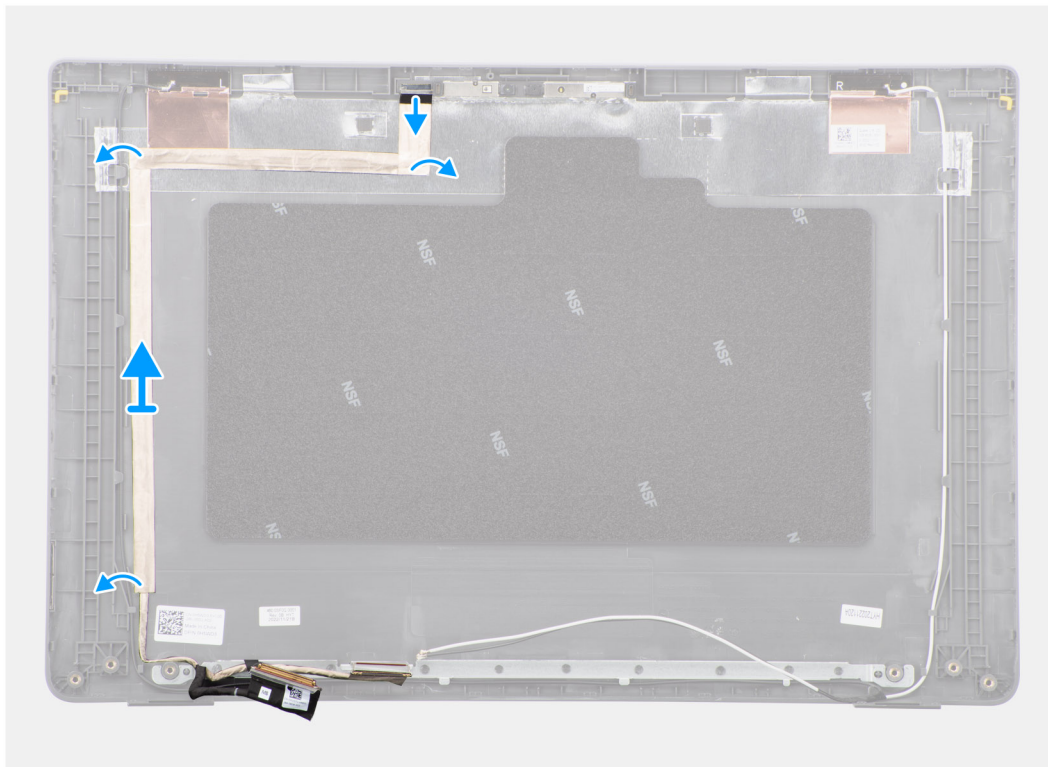

Figure 68. Removing the eDP cable

Steps

1. Disconnect the eDP cable from the connector on the camera module.
2. Peel the conductive tape and unroute the eDP cable to release it from adhesive and lift the eDP cable from the display back cover.

Installing the eDP cable

Prerequisites

If you are replacing a component, remove the existing component before performing the installation procedure.

About this task

The following image indicates the location of the eDP cable and provides a visual representation of the installation procedure.

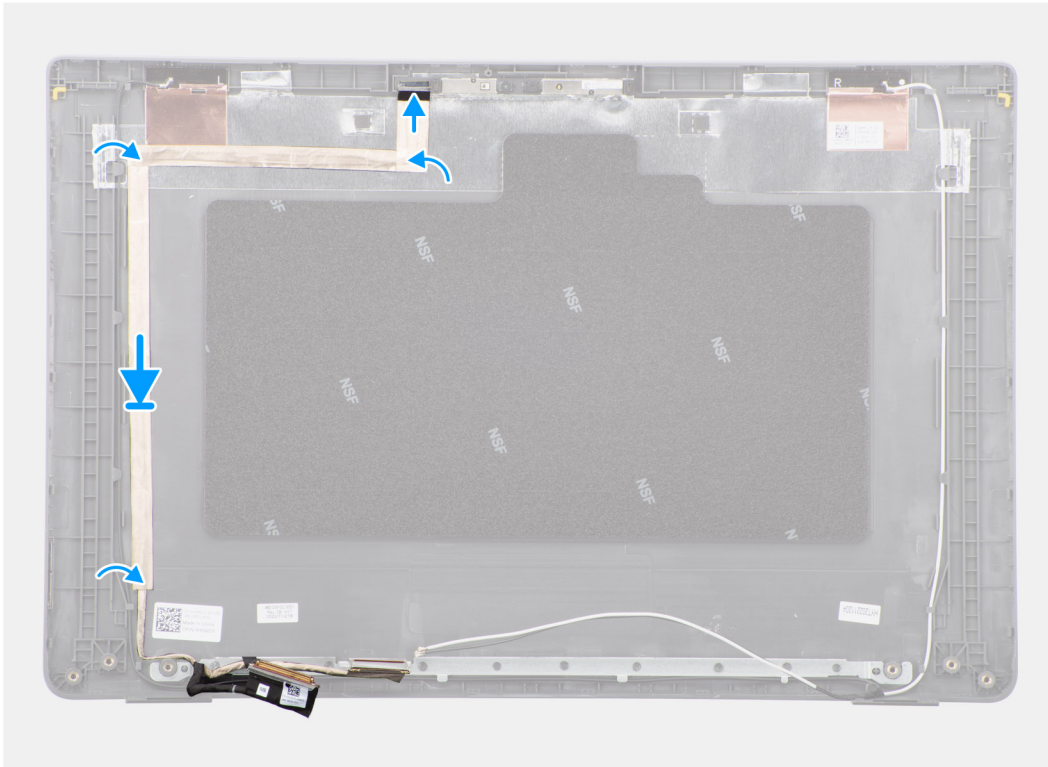

Figure 69. Installing the eDP cable

Steps

1. Connect the eDP cable to the connector on the camera module.
2. Adhere the eDP cable to the display back cover.
3. Adhere the conductive tape and route the eDP cable to the display back cover.

Next steps

1. Install the [camera](#).
2. Install the [display panel](#).
3. Install the [display bezel](#).
4. Install the [display assembly](#).
5. Install the [base cover](#).
6. Follow the procedure in [After working inside your computer](#).

Display back cover

Removing the display back cover

Prerequisites

1. Follow the procedure in [Before working inside your computer](#).
2. Remove the [base cover](#).
3. Remove the [display assembly](#).
4. Remove the [display bezel](#).
5. Remove the [display panel](#).
6. Remove the [camera](#).
7. Remove the [eDP cable](#).

About this task

The following image shows the display back cover and provide a visual representation of the removal procedure.

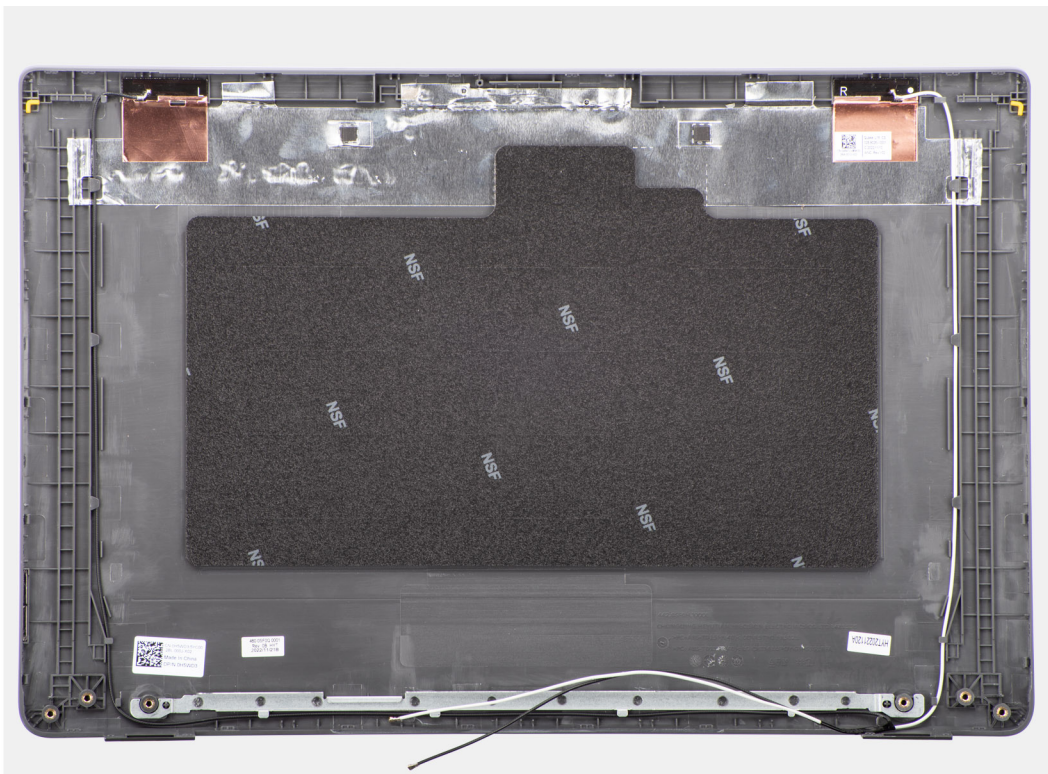

Figure 70. Removing the display back cover

Steps

After performing the steps in the pre-requisites, we are left with the display back cover.

Installing the display back cover

Prerequisites

If you are replacing a component, remove the existing component before performing the installation procedure.

About this task

The following image indicates the location of the display back cover and provides a visual representation of the installation procedure.

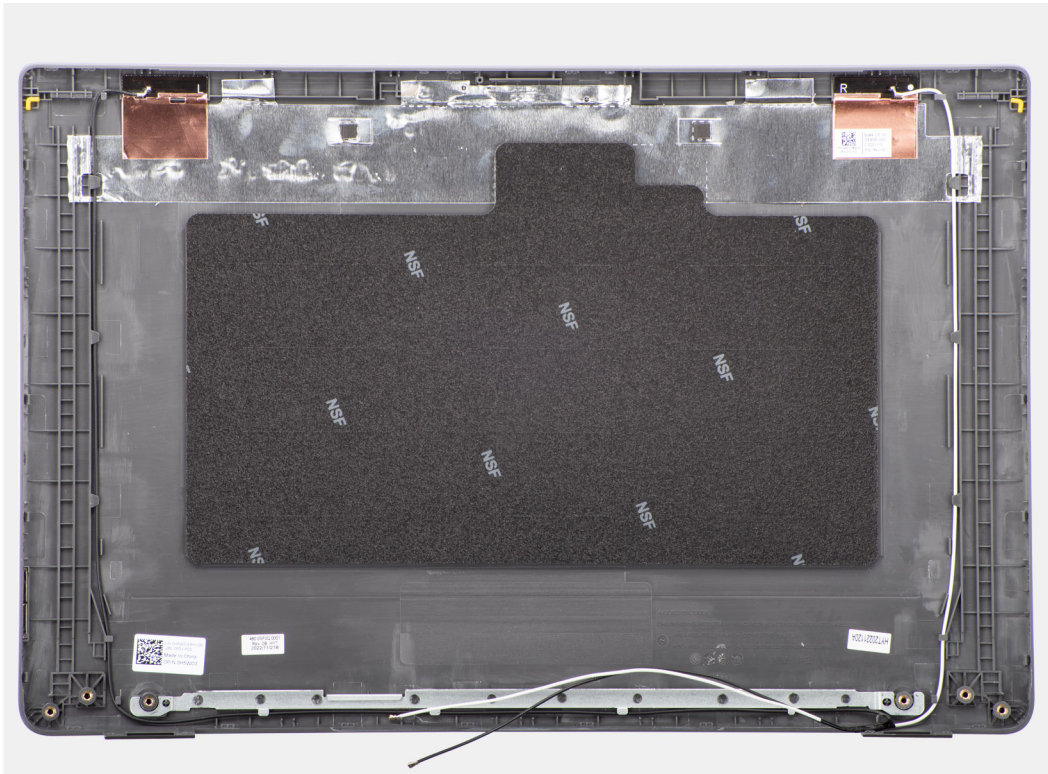

Figure 71. Installing the display back cover

Steps

Place the display back cover on a clean and flat surface.

Next steps

1. Install the [eDP cable](#).
2. Install the [camera](#).
3. Install the [display panel](#).
4. Install the [display bezel](#).
5. Install the [display assembly](#).
6. Install the [base cover](#).
7. Follow the procedure in [After working inside your computer](#).

Software

This chapter details the supported operating systems along with instructions on how to install the drivers.

Operating system

Your Latitude 3550 supports the following operating systems:

- Windows 11 Pro
- Windows 11 Home
- Ubuntu 22.04 LTS, 64-bit

Drivers and downloads

When troubleshooting, downloading, or installing drivers, it is recommended that you read the Dell Knowledge Base article [Drivers and Downloads FAQs 000123347](#).

BIOS Setup

CAUTION: Unless you are an expert computer user, do not change the settings in the BIOS Setup. Certain changes can make your computer work incorrectly.

NOTE: Depending on the computer and its installed devices, the items that are listed in this section may or may not be displayed.

NOTE: Before you change the settings in BIOS Setup, it is recommended that you note down the original settings for future reference.

Use BIOS Setup for the following purposes:

- Get information about the hardware installed in your computer, such as the amount of RAM and the size of the storage device.
- Change the system configuration information.
- Set or change a user-selectable option, such as the user password, type of hard drive installed, and enabling or disabling base devices.

Entering BIOS setup program

About this task

Turn on (or restart) your computer and press F2 immediately.

Navigation keys

NOTE: For most of the System Setup options, changes that you make are recorded but do not take effect until you restart the computer.

Table 31. Navigation keys

Keys	Navigation
Up arrow	Moves to the previous field.
Down arrow	Moves to the next field.
Enter	Selects a value in the selected field (if applicable) or follows the link in the field.
Spacebar	Expands or collapses a drop-down list, if applicable.
Tab	Moves to the next focus area. NOTE: For the standard graphical user interface only.
Esc	Moves to the previous page until you view the main screen. Pressing Esc in the main screen displays a message that prompts you to save any unsaved changes and restart the computer.

F12 One Time Boot menu

To enter the One Time Boot menu, turn on your computer, and then press F12 immediately.

 **NOTE:** It is recommended to shut down the computer, if it is on.

The F12 One Time Boot menu displays the devices that you can boot from including the diagnostic option. The boot menu options are:

- Removable Drive (if available)
- STXXXX Drive (if available)
 -  **NOTE:** XXX denotes the SATA drive number.
- Optical Drive (if available)
- SATA Hard Drive (if available)
- Diagnostics

The boot sequence screen also displays the option to access System Setup.

View Advanced Setup options

About this task

Some BIOS Setup options are only visible by enabling **Advanced Setup** mode, which is disabled by default.

 **NOTE:** BIOS Setup options, including **Advanced Setup** options, are described in [System setup options](#).

To enable Advanced Setup

Steps

1. Enter BIOS Setup.
The Overview menu appears.
2. Click the **Advanced Setup** option to move it to the **ON** mode.
Advanced BIOS Setup options are visible.

View Service options

About this task

Service options are hidden by default and only visible by entering a hotkey command.

 **NOTE:** Service options are described in [System setup options](#).

To view Service options:

Steps

1. Enter BIOS Setup.
The Overview menu appears.
2. Enter the hotkey combination **Ctrl +Alt + s** to view the **Service** options.
Service options are visible.

System setup options

 **NOTE:** Depending on your computer and its installed devices, the items that are listed in this section may or may not be displayed.

Table 32. System setup options—Overview menu

Overview	
Latitude 3550	
BIOS Version	Displays the BIOS version number.

Table 32. System setup options—Overview menu (continued)

Overview	
Service Tag	Displays the Service Tag of the computer.
Asset Tag	Displays the Asset Tag of the computer.
Manufacture Date	Displays the manufacture date of the computer.
Ownership Date	Displays the ownership date of the computer.
Express Service Code	Displays the Express Service Code of the computer.
Ownership Tag	Displays the Ownership Tag of the computer.
Signed Firmware Update	Displays whether the Signed Firmware Update is enabled on your computer. By default, the Signed Firmware Update option is enabled.
Battery Information	
Primary	Displays the primary battery of the computer.
Battery Level	Displays the battery level of the computer.
Battery State	Displays the battery state of the computer.
Health	Displays the battery health of the computer.
AC Adapter	Displays whether an AC adapter is connected. If connected, displays the type of AC adapter that is connected.
Battery Life Type	Displays battery life type of the computer.
Processor Information	
Processor Type	Displays the processor type.
Maximum Clock Speed	Displays the maximum processor clock speed.
Minimum Clock Speed	Displays the minimum processor clock speed.
Current Clock Speed	Displays the current processor clock speed.
Core Count	Displays the number of cores on the processor.
Processor ID	Displays the processor identification code.
Processor L2 Cache	Displays the processor L2 Cache size.
Processor L3 Cache	Displays the processor L3 Cache size.
Microcode Version	Displays the microcode version.
Intel Hyper-Threading Capable	Displays whether the processor is Hyper-Threading (HT) capable.
64-Bit Technology	Displays whether 64-bit technology is used.
Memory Information	
Memory Installed	Displays the total computer memory installed.
Memory Available	Displays the total computer memory available.
Memory Speed	Displays the memory speed.
Memory Channel Mode	Displays single or dual channel mode.
Memory Technology	Displays the technology that is used for the memory.
DIMM_SLOT 1	Displays DIMM_SLOT 1 of the computer.
DIMM_SLOT 2	Displays DIMM_SLOT 2 of the computer.
Devices Information	
Panel Type	Displays the Panel Type of the computer.

Table 32. System setup options—Overview menu (continued)

Overview	
Video Controller	Displays the video controller type of the computer.
Video Memory	Displays the video memory information of the computer.
Wi-Fi Device	Displays the wireless device information of the computer.
Native Resolution	Displays the native resolution of the computer.
Video BIOS Version	Displays the video BIOS version of the computer.
Audio Controller	Displays the audio controller information of the computer.
Bluetooth Device	Displays the Bluetooth device information of the computer.
LOM MAC Address	Displays the MAC address of the LAN on motherboard.
Pass Through MAC Address	Displays the MAC address of the video pass-through.
Cellular Device	Displays the cellular device information of the computer.
dGPU video controller	Displays the dGPU video controller information of the computer.

Table 33. System setup options—Boot Configuration menu

Boot Configuration	
Boot Sequence	
Boot Mode: UEFI only	Displays the boot mode of the computer.
Boot Sequence	Displays the boot sequence.
Secure Boot	Secure Boot is a method of guaranteeing the integrity of the boot path by performing additional validation of the operating system and PCI add-in cards. The computer stops booting to the operating system when a component is not authenticated during the boot process. Secure Boot can be enabled in BIOS setup or using management interfaces like Dell Command Configure, but can only be disabled from BIOS setup.
Enable Secure Boot	<p>Enables the computer to boot using only validated boot software.</p> <p>By default, the Enable Secure Boot option is enabled.</p> <p>For additional security, Dell Technologies recommends keeping the Secure Boot option enabled to ensure that the UEFI firmware validates the operating system during the boot process.</p> <p>i NOTE: For Secure Boot to be enabled, the computer is required to be in UEFI boot mode and the Enable Legacy Option ROMs option is required to be turned off.</p>
Secure Boot Mode	<p>Enables or disables the Secure Boot operation mode.</p> <p>By default, the Deployed Mode is selected.</p> <p>i NOTE: Deployed Mode should be selected for normal operation of Secure Boot.</p>
Enable Microsoft UEFI CA	<p>When disabled, the UEFI CA is removed from the BIOS UEFI Secure Boot database.</p> <p>i NOTE: When disabled, the Microsoft UEFI CA could render your computer unable to boot, computer graphics may not function, some devices may not function properly, and the computer could become unrecoverable.</p> <p>By default, the Enable Microsoft UEFI CA option is enabled.</p> <p>For additional security, Dell Technologies recommends keeping the Microsoft UEFI CA option enabled to ensure the broadest compatibility with devices and operating systems.</p>

Table 33. System setup options—Boot Configuration menu (continued)

Boot Configuration	
Expert Key Management	
Enable Custom Mode	Enables or disables the keys in the PK, KEK, db, and dbx security key databases to be modified. By default, the Enable Custom Mode option is disabled.
Custom Mode Key Management	Selects the custom values for expert key management. By default, the PK option is selected.

Table 34. System setup options—Integrated Devices menu

Integrated Devices	
Date/Time	
Date	Sets the computer date in MM/DD/YYYY format. Changes to the date format take effect immediately.
Time	Sets the computer time in HH/MM/SS 24-hour format. You can switch between a 12-hour and 24-hour clock. Changes to the time format take effect immediately.
Camera	
Enable Camera	Enables the camera. By default, the Enable Camera option is enabled. i NOTE: Depending on the configuration ordered, the camera setup option may not be available.
Audio	
Enable Audio	Enables all integrated audio controller. By default, all the options are enabled.
Enable Microphone	Enables the microphone. By default, the Enable Microphone option is enabled. i NOTE: Depending on the configuration ordered, the microphone setup option may not be available.
Enable Internal Speaker	Enables the internal speaker. By default, the Enable Internal Speaker option is enabled.
USB/Thunderbolt Configuration	
Enable USB Boot Support	Enables booting from USB mass storage devices that are connected to external USB ports. By default, the Enable USB Boot Support option is enabled.
Enable External USB Ports	Enables the external USB ports. By default, the Enable External USB Ports option is enabled.
Disable USB4 PCIE Tunneling	Disables the USB4 PCIE Tunneling option. By default, the Disable USB4 PCIE Tunneling option is disabled.
Miscellaneous Devices	
Enable Fingerprint Reader Device	Enables the Fingerprint Reader Device option. By default, the Enable Fingerprint Reader Device option is enabled.

Table 35. System setup options—Storage menu

Storage	
SATA/NVMe Operation	
SATA/NVMe Operation	Sets the operating mode of the integrated SATA hard drive controller. By default, the RAID On option is selected. The storage device is configured for RAID On mode.
Storage Interface	
Port Enablement	Enables or disables the M.2 PCIe SSD option. By default, the M.2 PCIe SSD option is enabled.
Drive Information	Displays the information of onboard drives.
Enable MediaCard	

Table 36. System setup options—Display menu

Display	
Display Brightness	
Brightness on battery power	Enables to set the screen brightness when the computer is running on battery power. By default, the screen brightness is set to 50 when the computer is running on battery power.
Brightness on AC power	Enables to set the screen brightness when the computer is running on AC power. By default, the screen brightness is set to 100 when the computer is running on AC power.
Touchscreen	Enables or disables the touch screen option. By default, the Touchscreen option is enabled.
Enable EcoPower	Enables or disables the EcoPower. By default, the EcoPower option is enabled.
Full Screen Logo	Enables or disables the computer to display a full-screen logo, if the image matches screen resolution. By default, the Full Screen Logo option is disabled.

Table 37. System setup options—Connection menu

Connection	
Integrated NIC	Controls the on-board LAN Controller. By default, the Enabled with PXE option enabled.
Wireless Device Enable	
WLAN	Enables or disables the internal WLAN device. By default, the WLAN option enabled.
Bluetooth	Enables or disables the internal Bluetooth device. By default, the Bluetooth option enabled.
Enable UEFI Network Stack	Enables or disables the UEFI Network Stack and controls the onboard LAN Controller. By default, the Enable UEFI Network Stack option is enabled.

Table 37. System setup options—Connection menu (continued)

Connection	
Wireless Radio Control	
Control WLAN Radio	Enables to sense the connection of the computer to a wired network and then disables the selected wireless radios (WLAN and/or WWAN). Upon disconnection from the wired network, the selected wireless radios are reenabled. By default, the Control WLAN Radio option is disabled.
HTTP(s) Boot	Enables or disables the HTTP(s) Boot capabilities. By default, the Auto Mode option is enabled.

Table 38. System setup options—Power menu

Power	
Battery Configuration	Enables or disables the computer to run on battery during peak power usage hours. Use the table Custom Charge Start and Custom Charge Stop , to prevent AC power usage between certain times of each day. By default, the Adaptive option is selected. Battery settings are adaptively optimized based on your typical battery usage pattern.
Advanced Configuration	
Enable Advanced Battery Charge Configuration	Enables Advanced Battery Charge Configuration from the beginning of the day to a specified work period. When enabled, Advanced Battery Charged maximizes battery health while still supporting heavy use during the work day. By default, the Enable Advanced Battery Charge Configuration option is disabled.
Peak Shift	
Enable Peak Shift	Enables the computer to run on battery during peak power usage hours. By default, the Enable Peak Shift option is disabled.
Thermal Management	Enables or disables cooling of fan and manages processor heat to adjust the computer performance, noise, and temperature. By default, the Optimized option is selected. Standard setting for balanced performance, noise, and temperature.
USB Wake Support	
Wake on Dell USB-C Dock	When enabled, connecting a Dell USB-C Dock wakes the computer from Standby, Hibernate, and Power Off. By default, the Wake on Dell USB-C Dock option is disabled.
Block Sleep	Enables or disables the computer from entering Sleep (S3) mode in the operating system. By default, the Block Sleep option is disabled. i NOTE: When enabled, the computer does not go to Sleep, Intel Rapid Start is disabled automatically, and the operating system power option is blank if it was set to Sleep.
Lid Switch	
Enable Lid Switch	Enables or disables the Lid Switch. By default, the Enable Lid Switch option is enabled.
Intel Speed Shift Technology	Enables or disables the Intel Speed Shift Technology support. When enabled, the operating system selects the appropriate processor performance automatically.

Table 38. System setup options—Power menu (continued)

Power	
By default, the Intel Speed Shift Technology option is enabled.	

Table 39. System setup options—Security menu

Security	
Trusted Platform Module (TPM)	<p>The Trusted Platform Module (TPM) provides various cryptographic services which serve as the cornerstone for many platform security technologies. Trusted Platform Module (TPM) is a security device that stores computer-generated keys for encryption and features such as BitLocker, Virtual Secure Mode, remote Attestation.</p> <p>By default, the Trusted Platform Module (TPM) option is enabled.</p> <p>For additional security, Dell Technologies recommends keeping Trusted Platform Module (TPM) enabled to allow these security technologies to fully function.</p> <p>NOTE: The options that are listed apply to computers with a discrete Trusted Platform Module (TPM) chip.</p>
TPM On	<p>Allows you to enable or disable TPM.</p> <p>By default, the TPM On option is enabled.</p> <p>For additional security, Dell Technologies recommends keeping TPM On enabled to allow these security technologies to fully function.</p>
Physical Presence Interface (PPI) Bypass for Enable Commands	<p>The Physical Presence Interface (PPI) Bypass options can be used to allow the operating system to manage certain aspects of the TPM. If these options are enabled, you are not prompted to confirm certain changes to the TPM configuration.</p> <p>By default, the PPI Bypass for Enable Commands option is enabled.</p> <p>For additional security, Dell Technologies recommends keeping the PPI Bypass for Enable Commands option enabled.</p>
Physical Presence Interface (PPI) Bypass for Disable Commands	<p>By default, the PPI Bypass for Disable Commands option is disabled.</p> <p>For additional security, Dell Technologies recommends keeping the PPI Bypass for Disable Commands option disabled.</p>
Physical Presence Interface (PPI) Bypass for Clear Commands	<p>By default, the PPI Bypass for Clear Commands option is disabled.</p> <p>For additional security, Dell Technologies recommends keeping the PPI Bypass for Clear Commands option disabled.</p>
Attestation Enable	<p>The Attestation Enable option controls the endorsement hierarchy of TPM. Disabling the Attestation Enable option prevents TPM from being used to digitally sign certificates.</p> <p>By default, the Attestation Enable option is enabled.</p> <p>For additional security, Dell Technologies recommends keeping the Attestation Enable option enabled.</p> <p>NOTE: When disabled, this feature may cause compatibility issues or loss of functionality in some operating systems.</p>
Key Storage Enable	<p>The Key Storage Enable option controls the storage hierarchy of TPM, which is used to store digital keys. Disabling the Key Storage Enable option restricts the ability of TPM to store owner's data.</p> <p>By default, the Key Storage Enable option is enabled.</p> <p>For additional security, Dell Technologies recommends keeping the Key Storage Enable option enabled.</p>

Table 39. System setup options—Security menu (continued)



Security	
	<p> NOTE: When disabled, this feature may cause compatibility issues or loss of functionality in some operating systems.</p>
SHA-256	<p>Allows you to control the hashing algorithm that is used by the TPM. When enabled, the TPM uses the SHA-256 hashing algorithm. When disabled, the TPM uses the SHA-1 hash algorithm.</p> <p>By default, the SHA-256 option is enabled.</p> <p>For additional security, Dell Technologies recommends keeping the SHA-256 option enabled.</p>
Clear	<p>When enabled, the Clear option clears information that is stored in the TPM after exiting the computer's BIOS. This option returns to the disabled state when the computer restarts.</p> <p>By default, the Clear option is disabled.</p> <p>Dell Technologies recommends enabling the Clear option only when TPM data is required to be cleared.</p>
TPM State	<p>Enables or disables the Trusted Platform Module (TPM). This is the normal operating state for the Trusted Platform Module (TPM) when you want to use its complete array of capabilities.</p> <p>By default, the TPM State option is enabled.</p>
Intel Platform Trust Technology (PTT)	<p>Intel PTT is a firmware-based Trusted Platform Module (fTPM) device that is part of Intel chipsets. It provides credential storage and key management that can replace the equivalent functionality of a discrete TPM chip.</p> <p> NOTE: The options that are listed apply to computers with a discrete Trusted Platform Module (TPM).</p>
PTT On	<p>Enables or disables the Intel PTT option.</p> <p>By default, the PTT On option is enabled.</p> <p>For additional security, Dell Technologies recommends keeping the PTT On option enabled.</p>
Physical Presence Interface (PPI) Bypass for Clear Commands	<p>The PPI Bypass for Clear Commands option allows the operating system to manage certain aspects of PTT. When enabled, you are not prompted to confirm changes to the PTT configuration.</p> <p>By default, the PPI Bypass for Clear Commands option is disabled.</p> <p>For additional security, Dell Technologies recommends keeping the PPI Bypass for Clear Commands option disabled.</p>
Clear	<p>When enabled, the Clear option clears the information that is stored in the PTT fTPM after exiting the computer's BIOS. This option returns to the disabled state when the computer restarts.</p> <p>By default, the Clear option is disabled.</p> <p>Dell Technologies recommends enabling the Clear option only when PTT fTPM data needs to be cleared.</p>
Chassis intrusion	
Chassis Intrusion Detection	<p>The chassis intrusion detection enables a physical switch that triggers an event when the computer cover is opened.</p> <p>When set to Enabled, a notification is displayed on the next boot and the event is logged in the BIOS Events log.</p> <p>When set to On-Silent, the event is logged in the BIOS Events log, but no notification is displayed.</p>

Table 39. System setup options—Security menu (continued)

Security	
	<p>When set to Disabled, no notification is displayed and no event is logged in the BIOS Events log.</p> <p>By default, the Chassis Intrusion Detection option is enabled.</p> <p>For additional security, Dell Technologies recommends keeping the Chassis Intrusion Detection option enabled.</p>
Block Boot Until Cleared	<p>Enables or disables the Block Boot Until Cleared option.</p> <p>By default, the Block Boot Until Cleared option is enabled.</p> <p>i NOTE: When enabled, the computer does not boot until the chassis intrusion is cleared. If the administrator password is set, Setup has to be unlocked before the warning can be cleared.</p>
OROM Keyboard Access	<p>The OROM Keyboard Access feature allows you to enter the Option ROM configuration screens using hotkeys during the boot process. This setting controls only the Intel RAID (CTRL+I), MEBX (CTRL+P), and LSI RAID (CTRL+C) Option ROMs. Other preboot Option ROMs which support entry via a key sequence are not affected by this setting.</p> <p>For additional security, Dell Technologies recommends keeping the OROM Keyboard Access option enabled.</p>
Legacy Manageability Interface Access	<p>Allows the administrator to control the access to BIOS configuration through the Legacy Manageability Interface option. When enabled, this prevents the BIOS Administrator password-based manageability tools from running, prevents some Dell software applications from reading configuration settings, and/or prevents changes to the BIOS configuration settings.</p> <p>When enabled, this option only supports the Authenticated BIOS Manageability Interface (ABI) for managing the BIOS configuration changes. To support this feature, ABI must be enabled and provisioned.</p> <p>When set to Enabled, the Legacy Manageability Interface can be used to read and change BIOS configuration settings.</p> <p>When set to Read-Only, BIOS configuration settings can be read, but cannot be changed through the Legacy Manageability Interface.</p> <p>When set to Disabled, the Legacy Manageability Interface is disabled. BIOS configuration reads and writes are blocked.</p>
SMM Security Mitigation	<p>Enables or disables additional UEFI SMM Security Mitigation protections. This option uses the Windows SMM Security Mitigations Table (WSMT) to confirm to the operating system that security best practices have been implemented by the UEFI firmware.</p> <p>By default, the SMM Security Mitigation option is enabled.</p> <p>For additional security, Dell Technologies recommends keeping the SMM Security Mitigation option enabled unless you have a specific application which is not compatible.</p> <p>i NOTE: This feature may cause compatibility issues or loss of functionality with some legacy tools and applications.</p>
Data Wipe on Next Boot	
Start Data Wipe	<p>Data Wipe is a secure wipe operation that deletes information from a storage device.</p> <p>⚠ CAUTION: The secure Data Wipe operation deletes information in a way that it cannot be reconstructed.</p> <p>Commands such as delete and format in the operating system may remove files from showing up in the file system. However, they can be reconstructed through</p>

Table 39. System setup options—Security menu (continued)

Security	
	<p>forensic means as they are still represented on the physical media. Data Wipe prevents this reconstruction and is not recoverable.</p> <p>When enabled, the data wipe option will prompt to wipe any storage devices that are connected to the computer on the next boot.</p> <p>By default, the Start Data Wipe option is disabled.</p>
Absolute	<p>Absolute Software provides various cyber security solutions, some requiring software preloaded on Dell computers and integrated into the BIOS. To use these features, you must enable the Absolute BIOS setting and contact Absolute for configuration and activation.</p> <p>By default, the Absolute option is enabled.</p> <p>For additional security, Dell Technologies recommends keeping the Absolute option enabled.</p> <p>NOTE: When the Absolute features are activated, the Absolute integration cannot be disabled from the BIOS setup screen.</p>
UEFI Boot Path Security	<p>Enables or disables the computer to prompt the user to enter the Administrator password (if set) when booting to a UEFI boot path device from the F12 boot menu.</p> <p>By default, the Always Except Internal HDD option is enabled.</p>
Firmware Device Tamper Detection	<p>Allows you to control the firmware device tamper detection feature. This feature notifies the user when the firmware device is tampered. When enabled, a screen warning messages are displayed on the computer and a tamper detection event is logged in the BIOS Events log. The computer fails to reboot until the event is cleared.</p> <p>By default, the Firmware Device Tamper Detection option is enabled.</p> <p>For additional security, Dell Technologies recommends keeping the Firmware Device Tamper Detection option enabled.</p>

Table 40. System setup options—Passwords menu

Passwords	
Administrator Password	<p>The Administrator Password prevents unauthorized access to the BIOS Setup options. Once the administrator password is set, the BIOS setup options can only be modified after providing the correct password.</p> <p>The following rules and dependencies apply to the Administrator Password -</p> <ul style="list-style-type: none"> • The administrator password cannot be set if computer and/or internal hard drive passwords are previously set. • The administrator password can be used in place of the computer and/or internal hard drive passwords. • When set, the administrator password must be provided during a firmware update. • Clearing the administrator password also clears the computer password (if set). <p>Dell Technologies recommends using an administrator password to prevent unauthorized changes to BIOS setup options.</p>
System Password	<p>The System Password prevents the computer from booting to an operating system without entering the correct password.</p> <p>The following rules and dependencies apply when the System Password is used -</p> <ul style="list-style-type: none"> • The computer shuts down when idle for approximately 10 minutes at the computer password prompt.

Table 40. System setup options—Passwords menu (continued)

<p>Passwords</p>	<ul style="list-style-type: none"> • The computer shuts down after three incorrect attempts to enter the computer password. • The computer shuts down when the Esc key is pressed at the System Password prompt. • The computer password is not prompted when the computer resumes from standby mode. <p>Dell Technologies recommends using the computer password in situations where it is likely that a computer may be lost or stolen.</p>
<p>Hard Drive Password</p>	<p>The Hard Drive Password can be set to prevent unauthorized access of the data stored on the hard drive. The computer prompts for the hard drive password during boot in order to unlock the drive. A password-secured hard drive stays locked even when removed from the computer or placed into another computer. It prevents an attacker from accessing data on the drive without authorization.</p> <p>The following rules and dependencies apply when the Hard Drive Password is used -</p> <ul style="list-style-type: none"> • The hard drive password option cannot be accessed when a hard drive is disabled in the BIOS setup. • The computer shuts down when idle for approximately 10 minutes at the hard drive password prompt. • The computer shuts down after three incorrect attempts to enter the hard drive password and treats the hard drive as not available. • The hard drive does not accept password unlock attempts after five incorrect attempts to enter the hard drive password from the BIOS Setup. The hard drive password must be reset for the new password unlock attempts. • The computer treats the hard drive as not available when the Esc key is pressed at the hard drive password prompt. • The hard drive password is not prompted when the computer resumes from standby mode. When the hard drive is unlocked by the user before the computer goes into standby mode, it remains unlocked after the computer resumes from standby mode. • If the computer and hard drive passwords are set to the same value, the hard drive unlocks after the correct computer password is entered. <p>Dell Technologies recommends using a hard drive password to protect unauthorized data access.</p>
<p>Owner Password</p>	<p>The Owner Password is typically used when a computer is loaned or leased, and the end user sets their own computer or hard drive password. The Owner Password can provide override access to unlock the computer when it is returned. The Owner Password cannot be set using BIOS Setup. System lessors are given a tool which enables them to configure the Owner Password.</p> <p>The following rules and dependencies apply when the Owner Password is used -</p> <ul style="list-style-type: none"> • The owner password cannot be set when the administrator password is already set. • The owner password can be used in place of the administrator, computer, or hard drive passwords. <p> NOTE: The hard drive password must have been set on the computer with the owner password.</p> <p>Dell Technologies recommends that only computer lessors use the owner password.</p>
<p>Strong Password</p>	<p>The Strong Password feature enforces stricter rules for administrator, owner, and computer passwords.</p> <p>When enabled, the following rules are enforced -</p> <ul style="list-style-type: none"> • The minimum length of the password is set to eight characters.

Table 40. System setup options—Passwords menu (continued)

Passwords	
	<ul style="list-style-type: none"> The password is required to include at least one upper case and one lower case character. <p>NOTE: These requirements do not affect the hard drive password.</p> <p>By default, the Strong Password option is enabled.</p> <p>For additional security, Dell Technologies recommends keeping the Strong Password option enabled as it requires passwords to be more complex.</p>
Password Configuration	<p>The Password configuration page includes several options for changing the requirements of BIOS passwords. You can modify the minimum and maximum length of the passwords and require passwords to contain certain character classes (upper case, lower case, digit, special character).</p> <p>Dell Technologies recommends setting the minimum password length to at least eight characters.</p>
Password Bypass	<p>The Password Bypass option allows the computer to reboot from the operating system without entering the computer or hard drive password. If the computer has already booted to the operating system, it is presumed that the user has already entered the correct computer or hard drive password.</p> <p>NOTE: This option does not remove the requirement to enter the password after shutting down.</p> <p>By default, the Password Bypass option is enabled.</p> <p>For additional security, Dell Technologies recommends keeping the Password Bypass option enabled.</p>
Password Changes	
Allow Non-Admin Password Changes	<p>The Allow Non-Admin Password Changes option in BIOS setup allows an end user to set or change the computer or hard drive passwords without entering the administrator password. This gives an administrator control over the BIOS settings but enables an end user to provide their own password.</p> <p>By default, the Allow Non-Admin Password Changes option is disabled.</p> <p>For additional security, Dell Technologies recommends keeping the Allow Non-Admin Password Changes option disabled.</p>
Non-Admin Setup Changes	<p>The Non-Admin Setup Changes option allows an end user to configure the wireless devices without requiring the administrator password.</p> <p>By default, the Non-Admin Setup Changes option is disabled.</p> <p>For additional security, Dell Technologies recommends keeping the Non-Admin Setup Changes option disabled.</p>
Admin Setup Lockout	<p>The Admin Setup Lockout option prevents an end user from even viewing the BIOS setup configuration without first entering the administrator password (if set).</p> <p>By default, the Admin Setup Lockout option is disabled.</p> <p>For additional security, Dell Technologies recommends keeping the Admin Setup Lockout option disabled.</p>
Recovery Password	<p>The Recovery Password can be used when a system owner forgets the administrator, system, or hard drive password. You can get an unlock code from Dell Support over the phone after verifying ownership details. The unlock code overrides and removes the existing password.</p> <p>NOTE: When a hard drive password is overridden using this method, the data on the hard drive is erased if secure erase was enabled when setting the password.</p>

Table 40. System setup options—Passwords menu (continued)

Passwords	
Master Password Lockout	
Enable Master Password Lockout	<p>The Master Password Lockout setting allows you to disable the Recovery Password feature. If the computer, administrator, or hard drive password is forgotten, the computer becomes unusable.</p> <p>NOTE: When the owner password is set, the Master Password Lockout option is not available.</p> <p>NOTE: When an internal hard drive password is set, it must first be cleared before Master Password Lockout can be changed.</p> <p>By default, the Enable Master Password Lockout option is disabled.</p> <p>Dell does not recommend enabling the Master Password Lockout unless you have implemented your own password recovery computer.</p>

Table 41. System setup options—Update, Recovery menu

Update, Recovery	
UEFI Capsule Firmware Updates	
Enable UEFI Capsule Firmware Updates	<p>Enables or disables BIOS updates through UEFI capsule update packages.</p> <p>NOTE: Disabling this option blocks the BIOS updates from services such as Microsoft Windows Update and Linux Vendor Firmware Service (LVFS).</p> <p>By default, the Enable UEFI Capsule Firmware Updates option is enabled.</p>
BIOS Recovery from Hard Drive	
	<p>Enables or disables the user to recover from certain corrupted BIOS conditions from a recovery file on the user primary hard drive or an external USB key.</p> <p>By default, the BIOS Recovery from Hard Drive option is enabled.</p> <p>NOTE: BIOS Recovery from Hard Drive is not available for self-encrypting drives (SED).</p> <p>NOTE: BIOS recovery is designed to fix the main BIOS block and cannot work if the Boot Block is damaged. In addition, this feature cannot work in the event of EC corruption, ME corruption, or a hardware issue. The recovery image must exist on an unencrypted partition on the drive.</p>
BIOS Downgrade	
Allow BIOS Downgrade	<p>Controls flashing of the computer firmware to previous revisions.</p> <p>By default, the Allow BIOS Downgrade option is enabled.</p>
SupportAssist OS Recovery	
	<p>Enables or disables the boot flow for SupportAssist OS Recovery tool in the event of certain computer errors.</p> <p>By default, the SupportAssist OS Recovery option is enabled.</p>
BIOSConnect	
	<p>Enables or disables cloud Service operating system recovery if the main operating system fails to boot with the number of failures equal to or greater than the value specified by the Auto operating system Recovery Threshold setup option and local Service operating system does not boot or is not installed.</p> <p>By default, the BIOSConnect option is enabled.</p>
Dell Auto OS Recovery Threshold	
	<p>Allows you to control the automatic boot flow for SupportAssist System Resolution Console and for Dell operating system Recovery Tool.</p> <p>By default, the Dell Auto OS Recovery Threshold value is set to 2.</p>

Table 42. System setup options—System Management menu

System Management	
Service Tag	Displays the Service Tag of the computer.
Asset Tag	Creates a computer Asset Tag that can be used by an IT administrator to uniquely identify a particular computer.  NOTE: Once set in BIOS, the Asset Tag cannot be changed.
AC Behavior	
Wake on AC	Enables or disables the computer to turn on and go to boot when AC power is supplied to the computer. By default, the Wake on AC option is disabled.
Wake on LAN	Enables or disables the computer to turn on by a special LAN signal. By default, the Wake on LAN option is disabled.
Auto On Time	Enable to set the computer to turn on automatically every day or on a preselected date and time. This option can be configured only if the Auto On Time is set to Everyday, Weekdays, or Selected Days. By default, the Auto On Time option is disabled.
OS Agent Requests	Enable to schedule onboard diagnostics and scans. By default, the OS Agent Requests option is enabled.
Power-on-Self-Test Automatic Recovery	Enable if the computer should become unresponsive before completing the BIOS Power-On-Self-Test, the BIOS will attempt to automatically recover the computer. By default, the Power-on-Self-Test Automatic Recovery option is enabled.

Table 43. System setup options—Keyboard menu

Keyboard	
Fn Lock Options	Enables or disables the Fn Lock option. By default, the Fn Lock option is enabled.
NumLock Options	Enables or disables the NumLock option. By default, the NumLock option is enabled.
Lock Mode	By default, the Lock Mode Secondary option is enabled. With this option, the F1-F12 keys scan the code for their secondary functions.
Keyboard Illumination	Configures the operating mode of the keyboard illumination feature. By default, the Bright option is selected. Enables the keyboard illumination feature at 100% brightness level.
Keyboard Backlight Timeout on AC	Sets the timeout value for the keyboard backlight when an AC adapter is connected to the computer. By default, the 10 seconds option is selected.
Keyboard Backlight Timeout on Battery	Sets the timeout value for the keyboard backlight when the computer is running only on the battery power. The keyboard backlight timeout value is only effective when the backlight is enabled. By default, the 10 seconds option is selected.

Table 44. System setup options—Preboot Behavior menu

Preboot Behavior	
Adapter Warnings	
Enable Dock Warning Messages	Enables the warning messages during boot when the adapters with less power capacity are detected. By default, the Enable Dock Warning Messages option is enabled.
Warnings and Errors	Enables or disables the action to be taken when a warning or error is encountered. By default, the Prompt on Warnings and Errors option is selected. Stop, prompt, and wait for user input when warnings or errors are detected.  NOTE: Errors deemed critical to the operation of the computer hardware stop the functioning of the computer.
USB-C Warnings	
Enable Dock Warning Messages	Enables the warning messages during boot when the USB-C adapters with less power capacity are detected. By default, the Enable Dock Warning Messages option is enabled.
Fastboot	Allows you to configure the speed of the UEFI boot process. By default, the Thorough option is selected. Performs complete hardware and configuration initialization during boot.
Extend BIOS POST Time	Sets the BIOS POST (Power-On Self-Test) load time. By default, the 0 seconds option is selected.
MAC Address Pass-Through	Replaces the external NIC MAC address (in a supported dock or dongle) with the selected MAC address from the computer. By default, the System Unique MAC Address option is selected.

Table 45. System setup options—Virtualization menu

Virtualization Support	
Intel Virtualization Technology	
Enable Intel Virtualization Technology (VT)	When enabled, the computer can run a Virtual Machine Monitor (VMM). By default, the Enable Intel Virtualization Technology (VT) option is enabled.
VT for Direct I/O	
Enable Intel VT for Direct I/O	When enabled, the computer can perform Virtualization Technology for Direct I/O (VT-d). VT-d is an Intel method that provides virtualization for memory map I/O. By default, the Enable Intel VT for Direct I/O option is enabled.
DMA Protection	
Enable Pre-Boot DMA Support	Allows you to control the Pre-Boot DMA protection for both internal and external ports. This option does not directly enable DMA protection in the operating system.  NOTE: This option is not available when the virtualization setting for IOMMU is disabled (VT-d/AMD Vi). By default, the Enable Pre-Boot DMA Support option is enabled. For additional security, Dell Technologies recommends keeping the Enable Pre-Boot DMA Support option enabled.

Table 45. System setup options—Virtualization menu (continued)



Virtualization Support	
	<p> NOTE: This option is provided only for compatibility purposes, since some older hardware is not DMA capable.</p>
Enable OS Kernel DMA Support	<p>Allows you to control the Kernel DMA protection for both internal and external ports. This option does not directly enable DMA protection in the operating system. For operating systems that support DMA protection, this setting indicates to the operating system that the BIOS supports the feature.</p> <p> NOTE: This option is not available when the virtualization setting for IOMMU is disabled (VT-d/AMD Vi).</p> <p>By default, the Enable OS Kernel DMA Support option is enabled.</p> <p> NOTE: This option is provided only for compatibility purposes, since some older hardware is not DMA capable.</p>
Internal Port DMA Compatibility Mode	<p>When enabled, BIOS will notify the OS that the internal ports are not DMA capable.</p> <p>By default, the Internal Port DMA Compatibility Mode option is disabled.</p>

Table 46. System setup options—Performance menu

Performance	
Multi-Core Support	
Multiple Atom Cores	<p>Enables to change the number of Atom cores available to the operating system. The default value is set to the maximum number of cores.</p> <p>By default, the All Cores option is selected.</p>
Intel SpeedStep	
Enable Intel SpeedStep Technology	<p>Enables the computer to dynamically adjust processor voltage and core frequency, decreasing average power consumption and heat production.</p> <p>By default, the Enable Intel SpeedStep Technology option is enabled.</p>
C-State Control	
Enable C-State Control	<p>Enables or disables the ability of the CPU to enter and exit low-power state. When disabled, it disables all C-states. When enabled, it enables all C-states that the chipset or platform allows.</p> <p>By default, the Enable C-State Control option is enabled.</p>
Intel Turbo Boost Technology	
Enable Intel Turbo Boost Technology	<p>Enables the Intel TurboBoost mode of the processor. When enabled, the Intel TurboBoost driver increases the performance of the CPU or graphics processor.</p> <p>By default, the Enable Intel Turbo Boost Technology option is enabled.</p>
Intel Hyper-Threading Technology	
Enable Intel Hyper-Threading Technology	<p>Enables the Intel Hyper-Threading mode of the processor. When enabled, the Intel Hyper-Threading increases the efficiency of the processor resources when multiple threads run on each core.</p> <p>By default, the Intel Hyper-Threading Technology option is enabled.</p>

Table 47. System setup options—System Logs menu

System Logs	
BIOS Event Log	
Clear BIOS Event Log	Allows you to select option to keep or clear BIOS events logs.

Table 47. System setup options—System Logs menu (continued)

System Logs	
	By default, the Keep Log option is selected.
Thermal Event Log	
Clear Thermal Event Log	Allows you to select option to keep or clear Thermal events logs. By default, the Keep Log option is selected.
Power Event Log	
Clear Power Event Log	Allows you to select option to keep or clear Power events logs. By default, the Keep Log option is selected.

Updating the BIOS

Updating the BIOS in Windows

About this task

 **CAUTION:** If BitLocker is not suspended before updating the BIOS, the next time you reboot the computer it will not recognize the BitLocker key. You will then be prompted to enter the recovery key to progress, and the computer will ask for this on each reboot. If the recovery key is not known this can result in data loss or an unnecessary operating system reinstall. For more information about this subject, search in the Knowledge Base Resource at www.dell.com/support.

Steps

1. Go to www.dell.com/support.
2. Click **Product support**. In the **Search support** box, enter the Service Tag of your computer, and then click **Search**.
 **NOTE:** If you do not have the Service Tag, use the SupportAssist feature to automatically identify your computer. You can also use the product ID or manually browse for your computer model.
3. Click **Drivers & Downloads**. Expand **Find drivers**.
4. Select the operating system installed on your computer.
5. In the **Category** drop-down list, select **BIOS**.
6. Select the latest version of BIOS, and click **Download** to download the BIOS file for your computer.
7. After the download is complete, browse the folder where you saved the BIOS update file.
8. Double-click the BIOS update file icon and follow the on-screen instructions.
For more information, search in the Knowledge Base Resource at www.dell.com/support.

Updating the BIOS in Ubuntu

To update the system BIOS on a computer that is installed with Ubuntu, see the knowledge base article [000131486](https://www.dell.com/support) at www.dell.com/support.

Updating the BIOS using the USB drive in Windows

About this task

 **CAUTION:** If BitLocker is not suspended before updating the BIOS, the next time you reboot the computer it will not recognize the BitLocker key. You will then be prompted to enter the recovery key to progress, and the computer will ask for this on each reboot. If the recovery key is not known this can result in data loss or an

unnecessary operating system reinstall. For more information about this subject, search in the Knowledge Base Resource at www.dell.com/support.

Steps

1. Follow the procedure from step 1 to step 6 in [Updating the BIOS in Windows](#) to download the latest BIOS setup program file.
2. Create a bootable USB drive. For more information, search in the Knowledge Base Resource at www.dell.com/support.
3. Copy the BIOS setup program file to the bootable USB drive.
4. Connect the bootable USB drive to the computer that needs the BIOS update.
5. Restart the computer and press **F12**.
6. Select the USB drive from the **One Time Boot Menu**.
7. Type the BIOS setup program filename and press **Enter**.
The **BIOS Update Utility** appears.
8. Follow the on-screen instructions to complete the BIOS update.

Updating the BIOS from the F12 One-Time boot menu

Update your computer BIOS using the BIOS update.exe file that is copied to a FAT32 USB drive and booting from the F12 One-Time boot menu.

About this task

 **CAUTION:** If BitLocker is not suspended before updating the BIOS, the next time you reboot the computer it will not recognize the BitLocker key. You will then be prompted to enter the recovery key to progress, and the computer will ask for this on each reboot. If the recovery key is not known this can result in data loss or an unnecessary operating system reinstall. For more information about this subject, search in the Knowledge Base Resource at www.dell.com/support.

BIOS Update

You can run the BIOS update file from Windows using a bootable USB drive or you can also update the BIOS from the F12 One-Time boot menu on the computer.

Most of the Dell computers built after 2012 have this capability, and you can confirm by booting your computer to the F12 One-Time Boot Menu to see if BIOS FLASH UPDATE is listed as a boot option for your computer. If the option is listed, then the BIOS supports this BIOS update option.

 **NOTE:** Only computers with the BIOS Flash Update option in the F12 One-Time boot menu can use this function.

Updating from the One-Time boot menu

To update your BIOS from the F12 One-Time boot menu, you need the following:

- USB drive formatted to the FAT32 file system (key does not have to be bootable)
- BIOS executable file that you downloaded from the Dell Support website and copied to the root of the USB drive
- AC power adapter that is connected to the computer
- Functional computer battery to flash the BIOS

Perform the following steps to perform the BIOS update flash process from the F12 menu:

 **CAUTION:** Do not turn off the computer during the BIOS update process. The computer may not boot if you turn off your computer.

Steps

1. From a turn off state, insert the USB drive where you copied the flash into a USB port of the computer.
2. Turn on the computer and press F12 to access the One-Time Boot Menu, select BIOS Update using the mouse or arrow keys then press Enter.
The flash BIOS menu is displayed.
3. Click **Flash from file**.
4. Select an external USB device.
5. Select the file and double-click the flash target file, and then click **Submit**.

6. Click **Update BIOS**. The computer restarts to flash the BIOS.
7. The computer will restart after the BIOS update is completed.

System and setup password

Table 48. System and setup password

Password type	Description
System password	Password that you must enter to log in to your system.
Setup password	Password that you must enter to access and make changes to the BIOS settings of your computer.

You can create a system password and a setup password to secure your computer.

 **CAUTION:** The password features provide a basic level of security for the data on your computer.

 **CAUTION:** Anyone can access the data that is stored on your computer, when not locked and left unattended.

 **NOTE:** System and setup password feature is disabled.

Assigning a System Setup password

Prerequisites

You can assign a new System or Admin Password only when the status is in **Not Set**.

About this task

To enter BIOS System Setup, press F2 immediately after a power-on or reboot.

Steps

1. In the **System BIOS** or **System Setup** screen, select **Security** and press Enter.
The **Security** screen is visible.
2. Select **System/Admin Password** and create a password in the **Enter the new password** field.
Use the following guidelines to assign the system password:
 - A password can have up to 32 characters.
 - At least one special character: "(! " # \$ % & ' * + , - . / : ; < = > ? @ [\] ^ _ ` { | })"
 - Numbers 0 to 9.
 - Upper case letters from A to Z.
 - Lower case letters from a to z.
3. Type the system password that you entered earlier in the **Confirm new password** field and click **OK**.
4. Press Esc and save the changes as prompted by the message.
5. Press Y to save the changes.
The computer restarts.

Deleting or changing an existing system setup password

Prerequisites

Ensure that the **Password Status** is Unlocked (in the System Setup) before attempting to delete or change the existing System and/or Setup password. You cannot delete or change an existing System or Setup password, if the **Password Status** is Locked.

About this task

To enter the System Setup, press F2 immediately after a power-on or reboot.

Steps

1. In the **System BIOS** or **System Setup** screen, select **System Security** and press Enter.
The **System Security** screen is displayed.
2. In the **System Security** screen, verify that the Password Status is **Unlocked**.
3. Select **System Password**, update, or delete the existing system password, and press Enter or Tab.
4. Select **Setup Password**, update, or delete the existing setup password, and press Enter or Tab.
 **NOTE:** If you change the System and/or Setup password, reenter the new password when prompted. If you delete the System and/or Setup password, confirm the deletion when prompted.
5. Press Esc. A message prompts you to save the changes.
6. Press Y to save the changes and exit from System Setup.
The computer restarts.

Clearing CMOS settings

About this task

 **CAUTION:** Clearing CMOS settings resets the BIOS settings on your computer.

Steps

1. Remove the [base cover](#).
2. Disconnect the battery cable from the system board.
3. Remove the [coin-cell battery](#).
4. Wait for one minute.
5. Replace the [coin-cell battery](#).
6. Connect the battery cable to the system board.
7. Replace the [base cover](#).

Clearing BIOS (System Setup) and System passwords

About this task

To clear the system or BIOS passwords, contact Dell technical support as described at www.dell.com/contactdell.

 **NOTE:** For information about how to reset Windows or application passwords, see the documentation accompanying Windows or your application.

Troubleshooting

Handling swollen rechargeable Li-ion batteries

Like most laptops, Dell laptops use Lithium-ion batteries. One type of Lithium-ion battery is the rechargeable Li-ion battery. Rechargeable Li-ion batteries have increased in popularity in recent years and have become standard in the electronics industry due to customer preferences for a slim form factor (especially with newer ultra-thin laptops) and long battery life. Inherent to rechargeable Li-ion battery technology is the potential for swelling of the battery cells.

A swollen battery may impact the performance of the laptop. To prevent possible further damage to the device enclosure or internal components leading to malfunction, discontinue the use of the laptop and discharge it by disconnecting the AC adapter and letting the battery drain.

Swollen batteries should not be used and should be replaced and disposed of properly. We recommend contacting Dell product support for options to replace a swollen battery under the terms of the applicable warranty or service contract, including options for replacement by a Dell authorized service technician.

The guidelines for handling and replacing rechargeable Li-ion batteries are as follows:

- Exercise caution when handling rechargeable Li-ion batteries.
- Discharge the battery before removing it from the system. To discharge the battery, unplug the AC adapter from the system and operate the system only on battery power. When the system will no longer turn on when the power button is pressed, the battery is fully discharged.
- Do not crush, drop, mutilate, or penetrate the battery with foreign objects.
- Do not expose the battery to high temperatures, or disassemble battery packs and cells.
- Do not apply pressure to the surface of the battery.
- Do not bend the battery.
- Do not use tools of any type to pry on or against the battery.
- If a battery gets stuck in a device as a result of swelling, do not try to free it as puncturing, bending, or crushing a battery can be dangerous.
- Do not attempt to reassemble a damaged or swollen battery into a laptop.
- Swollen batteries that are covered under warranty should be returned to Dell in an approved shipping container (provided by Dell)—this is to comply with transportation regulations. Swollen batteries that are not covered under warranty should be disposed of at an approved recycling center. Contact Dell product support at <https://www.dell.com/support> for assistance and further instructions.
- Using a non-Dell or incompatible battery may increase the risk of fire or explosion. Replace the battery only with a compatible battery purchased from Dell that is designed to work with your Dell computer. Do not use a battery from other computers with your computer. Always purchase genuine batteries from <https://www.dell.com> or otherwise directly from Dell.

Rechargeable Li-ion batteries can swell for various reasons such as age, number of charge cycles, or exposure to high heat. For more information about how to improve the performance and lifespan of the laptop battery and to minimize the possibility of occurrence of the issue, search Dell Laptop Battery in the Knowledge Base Resource at www.dell.com/support.

Locate the Service Tag or Express Service Code of your Dell computer

Your Dell computer is uniquely identified with a Service Tag or Express Service Code. To view relevant support resources for your Dell computer, we recommend entering the Service Tag or Express Service Code at www.dell.com/support.

For more information about how to find the Service Tag for your computer, see [Locate the Service Tag on your computer](#).

Dell SupportAssist Pre-boot System Performance Check diagnostics

About this task

SupportAssist diagnostics (also known as system diagnostics) performs a complete check of your hardware. The Dell SupportAssist Pre-boot System Performance Check diagnostics is embedded with the BIOS and launched by the BIOS internally. The embedded system diagnostics provides options for particular devices or device groups allowing you to:

- Run tests automatically or in an interactive mode.
- Repeat the tests.
- Display or save test results.
- Run thorough tests to introduce additional test options to provide extra information about one or more failed devices.
- View status messages that inform you the tests are completed successfully.
- View error messages that inform you of problems encountered during testing.

 **NOTE:** Some tests for specific devices require user interaction. Always ensure that you are present at the computer terminal when the diagnostic tests are performed.

For more information, see the knowledge base article [000180971](#).

Running the SupportAssist Pre-Boot System Performance Check

Steps

1. Turn on your computer.
2. As the computer boots, press the F12 key as the Dell logo appears.
3. On the boot menu screen, select the **Diagnostics** option.
4. Click the arrow at the bottom left corner.
Diagnostics front page is displayed.
5. Click the arrow in the lower-right corner to go to the page listing.
The items that are detected are listed.
6. To run a diagnostic test on a specific device, press Esc and click **Yes** to stop the diagnostic test.
7. Select the device from the left pane and click **Run Tests**.
8. If there are any issues, error codes are displayed.
Note the error code and validation number and contact Dell.

Built-in self-test (BIST)

M-BIST

M-BIST (Built In Self-Test) is the system board built-in self-test diagnostics tool that improves the diagnostics accuracy of system board Embedded Controller (EC) failures.

 **NOTE:** M-BIST can be manually initiated before Power On Self-Test (POST).

How to run M-BIST

 **NOTE:** M-BIST must be initiated on the computer from a power-off state that is either connected to AC power or with a battery only.

1. Press and hold both the **M** key on the keyboard and the **power button** to initiate M-BIST.
2. The battery indicator LED may exhibit two states:
 - a. OFF: No fault was detected with the system board.
 - b. AMBER: Amber indicates a problem with the system board.

- If there is a failure with the system board, the battery status LED flashes one of the following error codes for 30 seconds:

Table 49. LED error codes

Blinking Pattern		Possible Problem
Amber	White	
2	1	CPU Failure
2	8	LCD Power Rail Failure
1	1	TPM Detection Failure
2	4	Memory/RAM failure

- If there is no failure with the system board, the LCD cycles through the solid color screens that are described in the LCD-BIST section for 30 seconds and then turn off.

LCD Power rail test (L-BIST)

L-BIST is an enhancement to the single LED error code diagnostics and is automatically initiated during POST. L-BIST will check the LCD power rail. If there is no power being supplied to the LCD (that is if the L-BIST circuit fails), the battery status LED flashes either an error code [2,8] or an error code [2,7].

NOTE: If L-BIST fails, LCD-BIST cannot function as no power will be supplied to the LCD.

How to invoke the L-BIST Test:

- Press the power button to start the computer.
- If the computer does not start up normally, look at the battery status LED:
 - If the battery status LED flashes an error code [2,7], the display cable may not be connected properly.
 - If the battery status LED flashes an error code [2,8], there is a failure on the LCD power rail of the system board, hence there is no power that is supplied to the LCD.
- For cases, when a [2,7] error code is shown, check to see if the display cable is properly connected.
- For cases when a [2,8] error code is shown, replace the system board.

LCD Built-in Self-Test (BIST)

Dell laptops have a built-in diagnostic tool that helps you determine if the screen abnormality you are experiencing is an inherent problem with the LCD (screen) of the Dell laptop or with the video card (GPU) and computer settings.

When you notice screen abnormalities like flickering, distortion, clarity issues, fuzzy or blurry image, horizontal or vertical lines, color fade and so on, it is always a good practice to isolate the LCD (screen) by running the Built-In Self-Test (BIST).

How to invoke the LCD BIST Test

- Power off the Dell laptop.
- Disconnect any peripherals that are connected to the laptop. Connect only the AC adapter (charger) to the laptop.
- Ensure that the LCD (screen) is clean (no dust particles on the surface of the screen).
- Press and hold the **D** key and **Power on** the laptop to enter LCD built-in self-test (BIST) mode. Continue to hold the D key until the computer boots up.
- The screen displays solid colors and change colors on the entire screen to white, black, red, green, and blue twice.
- Then it displays the colors white, black, and red.
- Carefully inspect the screen for abnormalities (any lines, fuzzy color, or distortion on the screen).
- At the end of the last solid color (red), the computer shuts down.

NOTE: Dell SupportAssist Preboot diagnostics upon launch initiates an LCD BIST first, expecting a user intervention to confirm functionality of the LCD.

System-diagnostic lights

This section lists the system-diagnostic lights of your Latitude 3550.

Table 50. System-diagnostic lights

Blinking pattern		Problem description
Amber	White	
1	1	TPM detection failure
1	2	Unrecoverable SPI Flash Failure
1	5	EC unable to program i-Fuse
1	6	Generic catch-all for ungraceful EC code flow errors
1	7	Non-RPMC Flash on Boot Guard fused system
2	1	CPU failure
2	2	System board failure (included BIOS corruption or ROM error)
2	3	No memory or RAM detected
2	4	Memory or RAM failure
2	5	Invalid memory installed
2	6	System board or Chipset Error
2	7	LCD failure (SBIOS message)
2	8	LCD failure (EC detection of power rail failure)
3	1	CMOS battery failure
3	2	PCI or Video card or chip failure
3	3	BIOS Recovery image not found
3	4	BIOS Recovery image found but invalid
3	5	Power rail failure
3	6	Flash corruption is detected by SBIOS.
3	7	Timeout waiting on ME to reply to HECI message.

NOTE: Blinking 3-3-3 LEDs on Lock LED (Caps-Lock or Num-Lock), Power button LED (without Fingerprint reader), and Diagnostic LED indicates failure to provide input during LCD panel test on Dell SupportAssist Pre-boot System Performance Check diagnostics.

Recovering the operating system

When your computer is unable to boot to the operating system even after repeated attempts, it automatically starts Dell SupportAssist OS Recovery.

Dell SupportAssist OS Recovery is a stand-alone tool that is preinstalled in all Dell computers that are installed with the Windows operating system. It consists of tools to diagnose and troubleshoot issues that may occur before your computer boots to the operating system. It enables you to diagnose hardware issues, repair your computer, back up your files, or restore your computer to its factory state.

You can also download it from the Dell Support website to troubleshoot and fix your computer when it fails to boot into their primary operating system due to software or hardware failures.

For more information about the Dell SupportAssist OS Recovery, see *Dell SupportAssist OS Recovery User's Guide* at www.dell.com/serviceabilitytools. Click **SupportAssist** and then, click **SupportAssist OS Recovery**.

Real-Time Clock (RTC Reset)

The Real Time Clock (RTC) reset function allows you or the service technician to recover Dell computers from No POST/No Power/No Boot situations. The legacy jumper enabled RTC reset has been retired on these models.

Start the RTC reset with the computer powered off and connected to AC power. Press and hold the power button for thirty (30) seconds

. The computer RTC Reset occurs after you release the power button.

Backup media and recovery options

It is recommended to create a recovery drive to troubleshoot and fix problems that may occur with Windows. Dell proposes multiple options for recovering the Windows operating system on your Dell computer. For more information, see [Dell Windows Backup Media and Recovery Options](#).

Wi-Fi power cycle

About this task

If your computer is unable to access the Internet due to Wi-Fi connectivity issues a Wi-Fi power cycle procedure may be performed. The following procedure provides the instructions on how to conduct a Wi-Fi power cycle:

 **NOTE:** Some Internet Service Providers (ISPs) provide a modem or router combo device.

Steps

1. Turn off your computer.
2. Turn off the modem.
3. Turn off the wireless router.
4. Wait for 30 seconds.
5. Turn on the wireless router.
6. Turn on the modem.
7. Turn on your computer.

Drain residual flea power (perform hard reset)

About this task

Flea power is the residual static electricity that remains in the computer even after it has been powered off and the battery is removed.

For your safety, and to protect the sensitive electronic components in your computer, you are requested to drain residual flea power before removing or replacing any components in your computer.

Draining residual flea power, also known as a performing a "hard reset", is also a common troubleshooting step if your computer does not turn on or boot into the operating system.

Procedure to drain residual flea power (perform a hard reset)

Steps

1. Turn off your computer.

2. Disconnect the power adapter from your computer.
3. Remove the base cover.
4. Remove the battery.
5. Press and hold the power button for 20 seconds to drain the flea power.
6. Install the battery.
7. Install the base cover.
8. Connect the power adapter to your computer.
9. Turn on your computer.

 **NOTE:** For more information about performing a hard reset, search in the Knowledge Base Resource at www.dell.com/support.

Getting help and contacting Dell

Self-help resources

You can get information and help on Dell products and services using these self-help resources:

Table 51. Self-help resources

Self-help resources	Resource location
Information about Dell products and services	www.dell.com
Tips	
Contact Support	In Windows search, type <code>Contact Support</code> , and press Enter.
Online help for operating system	www.dell.com/support/windows www.dell.com/support/linux
Access top solutions, diagnostics, drivers and downloads, and learn more about your computer through videos, manuals, and documents.	Your Dell computer is uniquely identified by a Service Tag or Express Service Code. To view relevant support resources for your Dell computer, enter the Service Tag or Express Service Code at www.dell.com/support . For more information about how to find the Service Tag for your computer, see Locate the Service Tag on your computer .
Dell knowledge base articles	<ol style="list-style-type: none"> 1. Go to www.dell.com/support. 2. On the menu bar at the top of the Support page, select Support > Knowledge Base. 3. In the Search field on the Knowledge Base page, type the keyword, topic, or model number, and then click or tap the search icon to view the related articles.

Contacting Dell

To contact Dell for sales, technical support, or customer service issues, see www.dell.com/contactdell.

 **NOTE:** Availability varies by country/region and product, and some services may not be available in your country/region.

 **NOTE:** If you do not have an active Internet connection, you can find contact information about your purchase invoice, packing slip, bill, or Dell product catalog.