

Dell Pro 13 Premium

PA13250

Owner's Manual

Notes, cautions, and warnings

 **NOTE:** A NOTE indicates important information that helps you make better use of your product.

 **CAUTION:** A CAUTION indicates either potential damage to hardware or loss of data and tells you how to avoid the problem.

 **WARNING:** A WARNING indicates a potential for property damage, personal injury, or death.

Chapter 1: Views of Dell Pro 13 Premium PA13250	7
Right	7
Left	8
Top	9
Top (for computers shipped with Collaboration Touchpad)	10
Front	11
Bottom	12
Locate the Service Tag or Express Service Code label of your computer	12
Battery-charge status light	13
Chapter 2: Set up your Dell Pro 13 Premium PA13250	14
Chapter 3: Specifications of Dell Pro 13 Premium PA13250	16
Dimensions and weight	16
Processor	16
Chipset	17
Operating system	17
Memory	17
External ports and slots	18
Internal slots	18
Wireless module	18
WWAN module	19
Audio	20
Storage	20
Keyboard	21
Keyboard shortcuts of Dell Pro 13 Premium PA13250	21
Camera	23
Touchpad	24
Touchpad with collaboration controls (optional)	24
Power adapter	25
Power adapter requirements of Dell Pro 13 Premium PA13250 (for computers shipped with 2-cell, 40 Wh battery)	26
Power adapter requirements of Dell Pro 13 Premium PA13250 (for computers shipped with 3-cell, 60 Wh battery)	26
Battery	27
Display	29
Fingerprint reader (optional)	29
Sensor	30
GPU—Integrated	30
Multiple display support matrix	30
Hardware security	31
Operating and storage environment	31
Dell support policy	31
ComfortView Plus	32
Dell Optimizer	32

Chapter 4: Working inside your computer	33
Safety instructions.....	33
Before working inside your computer.....	33
Safety precautions.....	34
Electrostatic discharge—ESD protection.....	34
ESD Field Service kit	35
Transporting sensitive components.....	36
After working inside your computer.....	36
BitLocker.....	36
Recommended tools.....	36
Screw list.....	37
Major components of Dell Pro 13 Premium PA13250.....	38
Chapter 5: Removing and installing Customer Replaceable Units (CRUs)	41
nano-SIM card tray.....	41
Removing the nano-SIM card tray	41
Installing the nano-SIM card tray	42
nano-SIM card.....	43
Removing the nano-SIM card.....	43
Installing the nano-SIM card.....	44
Base cover.....	45
Removing the base cover.....	45
Installing the base cover.....	48
Battery.....	49
Rechargeable Li-ion battery precautions.....	49
Removing the battery.....	50
Installing the battery.....	51
Solid state drive (SSD).....	53
Removing the M.2 2230 solid state drive.....	53
Installing the M.2 2230 solid state drive.....	54
Wireless Wide Area Network (WWAN) card.....	55
Removing the WWAN card	55
Installing the WWAN card	56
Fan.....	58
Removing the left fan	58
Installing the left fan.....	59
Removing the right fan	59
Installing the right fan.....	60
Speakers.....	61
Removing the speakers without antenna (WLAN configuration)	61
Installing the speakers without antenna (WLAN configuration)	62
Chapter 6: Removing and installing Field Replaceable Units (FRUs)	64
Speakers.....	64
Removing the speakers with antennas (WWAN configuration).....	64
Installing the speakers with antennas (WWAN configuration).....	65
Heat sink.....	67
Removing the heat sink.....	67

Installing the heat sink.....	68
I/O board.....	69
Removing the left I/O-board.....	69
Installing the left I/O-board.....	70
Removing the right I/O-board (without WWAN antennas).....	72
Installing the right I/O-board (without WWAN antennas).....	74
Removing the right I/O-board (with WWAN antennas).....	76
Installing the right I/O-board (with WWAN antennas).....	78
USB Type-C module.....	80
Removing the left USB Type-C module.....	80
Installing the left USB Type-C module	81
Removing the right USB Type-C module.....	82
Installing the right USB Type-C module.....	83
Power button.....	84
Removing the power button.....	84
Installing the power button.....	86
Display assembly.....	87
Removing the display assembly	87
Installing the display assembly	90
System board.....	92
Removing the system board	92
Installing the system board	96
Keyboard.....	101
Removing the keyboard assembly.....	101
Installing the keyboard assembly	103
Palm-rest assembly.....	106
Removing the palm-rest assembly	106
Installing the palm-rest assembly	107
Chapter 7: Software.....	109
Operating system.....	109
Drivers and downloads.....	109
Chapter 8: BIOS Setup.....	110
Entering BIOS Setup program.....	110
Navigation keys.....	110
F12 One Time Boot menu.....	110
View Advanced Setup options.....	111
View Service options.....	111
System Setup options.....	111
Updating the BIOS.....	131
Updating the BIOS in Windows.....	131
Updating the BIOS using the USB drive in Windows.....	132
Updating the BIOS in Linux and Ubuntu.....	132
Updating the BIOS from the One-Time boot menu.....	132
System and setup password.....	133
Assigning a System Setup password.....	133
Deleting or changing an existing system password or setup password.....	134
Clearing system and setup passwords.....	134

Clearing Chassis Intrusion Alerts.....	134
Chapter 9: Troubleshooting.....	137
Handling swollen rechargeable Li-ion batteries.....	137
Dell SupportAssist Pre-boot System Performance Check diagnostics.....	137
Running the SupportAssist Pre-Boot System Performance Check.....	138
Built-in self-test (BIST).....	138
(Motherboard Built-In Self-Test) M-BIST.....	138
Logical Built-in Self-test (L-BIST).....	139
LCD Built-in Self-Test (LCD-BIST).....	139
System-diagnostic lights.....	139
Recovering the operating system.....	140
Real-Time Clock (RTC Reset).....	141
Backup media and recovery options.....	141
Network power cycle.....	141
Drain flea power (perform hard reset).....	141
Chapter 10: Getting help and contacting Dell.....	143

Views of Dell Pro 13 Premium PA13250

Right

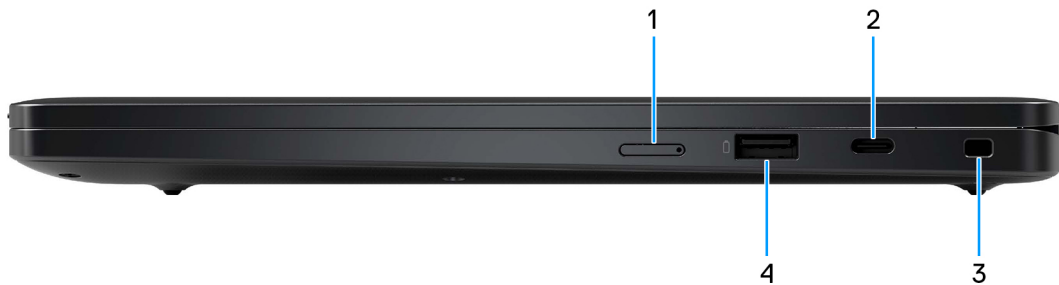

Figure 1. Right view

1. nano-SIM card slot

Insert a nano-SIM card to connect to a mobile broadband network.

2. Thunderbolt 4 port with DisplayPort Alt Mode/USB4/Power Delivery

Supports USB4, DisplayPort 1.4, Thunderbolt 4 and also enables you to connect to an external display using a display adapter. Supports data transfer rates of up to 40 Gbps for USB4 and Thunderbolt 4.

NOTE: You can connect a Dell Docking Station to the Thunderbolt 4 ports. For more information, search in the Knowledge Base Resource at [Dell Support Site](#).

NOTE: A USB Type-C to DisplayPort adapter (sold separately) is required to connect a DisplayPort device.

NOTE: USB4 is backward compatible with USB 3.2, USB 2.0, and Thunderbolt 3.

NOTE: Thunderbolt 4 supports two 4K displays or one 8K display.

3. Wedge-shaped lock slot

Connect a security cable to prevent unauthorized movement of your computer.

4. USB 3.2 Gen 1 port with PowerShare

Connect devices such as external storage devices and printers.

Supports data transfer speeds up to 5 Gbps. PowerShare enables you to charge your USB devices even when your computer is turned off.

NOTE: If your computer is turned off or in a hibernating state, you must connect the power adapter to charge your devices using the PowerShare port. You must enable this feature in the BIOS setup program.

NOTE: Certain USB devices may not charge when the computer is turned off or in a sleep state. In such cases, turn on the computer to charge the device.

Left

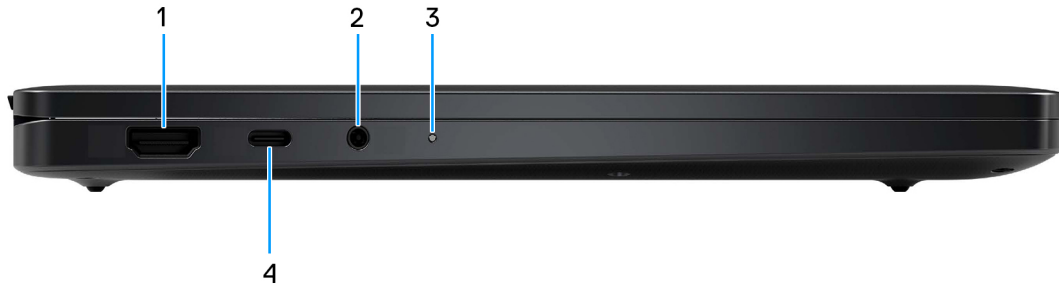

Figure 2. Left view

1. HDMI 2.1 port

Connect to a TV, external display, or another HDMI-in enabled device. Provides video and audio output.

2. Universal audio port

Connect headphones or a headset (headphone and microphone combo).

3. Battery indicator LED

Indicates the battery-charge status.

- Solid amber-Battery charge is low.
- Off-Battery is fully charged.

4. Thunderbolt 4 port with DisplayPort Alt Mode/USB4/Power Delivery

Supports USB4, DisplayPort 1.4, Thunderbolt 4 and also enables you to connect to an external display using a display adapter. Supports data transfer rates of up to 40 Gbps for USB4 and Thunderbolt 4.

i **NOTE:** You can connect a Dell Docking Station to the Thunderbolt 4 ports. For more information, search in the Knowledge Base Resource at [Dell Support Site](#).

i **NOTE:** A USB Type-C to DisplayPort adapter (sold separately) is required to connect a DisplayPort device.

i **NOTE:** USB4 is backward compatible with USB 3.2, USB 2.0, and Thunderbolt 3.

i **NOTE:** Thunderbolt 4 supports two 4K displays or one 8K display.

Top



Figure 3. Top view

1. Camera shutter

Slide the privacy shutter to the left to access the camera lens.

2. Power button with optional fingerprint reader

Press to turn on the computer if it is turned off, in sleep state, or in hibernating state.

When the computer is turned on, press the power button to put the computer into a sleep state; press and hold the power button for 10 s to force shut-down the computer.

If the power button has a fingerprint reader, place your finger on the power button steadily to log in.

NOTE: You can customize the power-button behavior in Windows.

3. Speakers

Provides audio output.

4. Zero-Lattice Keyboard with battery-saving backlight

Compact keyboard with larger keycaps and power-saving mini-LED backlight. Use the keyboard to input characters and perform functions.

5. Touchpad

Move your finger on the touchpad to move the mouse pointer.

Top (for computers shipped with Collaboration Touchpad)



Figure 4. Top view

1. Camera shutter

Slide the privacy shutter to the left to access the camera lens.

2. Power button with optional fingerprint reader

Press to turn on the computer if it is turned off, in sleep state, or in hibernating state.

When the computer is turned on, press the power button to put the computer into a sleep state; press and hold the power button for 10 s to force shut-down the computer.

If the power button has a fingerprint reader, place your finger on the power button steadily to log in.

NOTE: You can customize the power-button behavior in Windows.

3. Speakers

Provides audio output.

4. Zero-Lattice Keyboard with battery-saving backlight

Compact keyboard with larger keycaps and power-saving mini-LED backlight. Use the keyboard to input characters and perform functions.

5. Microphone control (Zoom app and Teams for work or school (Windows desktop) app support only)

Tap to mute or unmute the microphone. The microphone control indicates the status of the microphone as follows:

- Red – The microphone is muted.
- White – The microphone is unmuted.

6. Chat box control (Zoom app and Teams for work or school (Windows desktop) app support only)

Tap to show or hide the chat window. The control blinks when you receive a new chat message.

7. Screen share control (Zoom app and Teams for work or school (Windows desktop) app support only)

Tap to start or stop sharing your screen.

8. Webcam control (Zoom app and Teams for work or school (Windows desktop) app support only)

Tap to turn on or turn off the camera. The webcam control indicates the status of the camera as follows:

- Red – The camera is turned off.
- White – The camera is turned on.

Front



Figure 5. Front view

1. IR camera

Enhances security when paired with Windows Hello face authentication.

2. IR emitter

Emits infrared light, which enables the infrared camera to sense and track motion.

3. RGB camera

Enables you to video chat, capture photos, and record videos.

4. Camera indicator LED

Turns on when the camera is in use.

5. Ambient Light Sensor

Detects the ambient light and automatically adjusts the display brightness.

6. Display panel

Provides visual output to the user.

Bottom

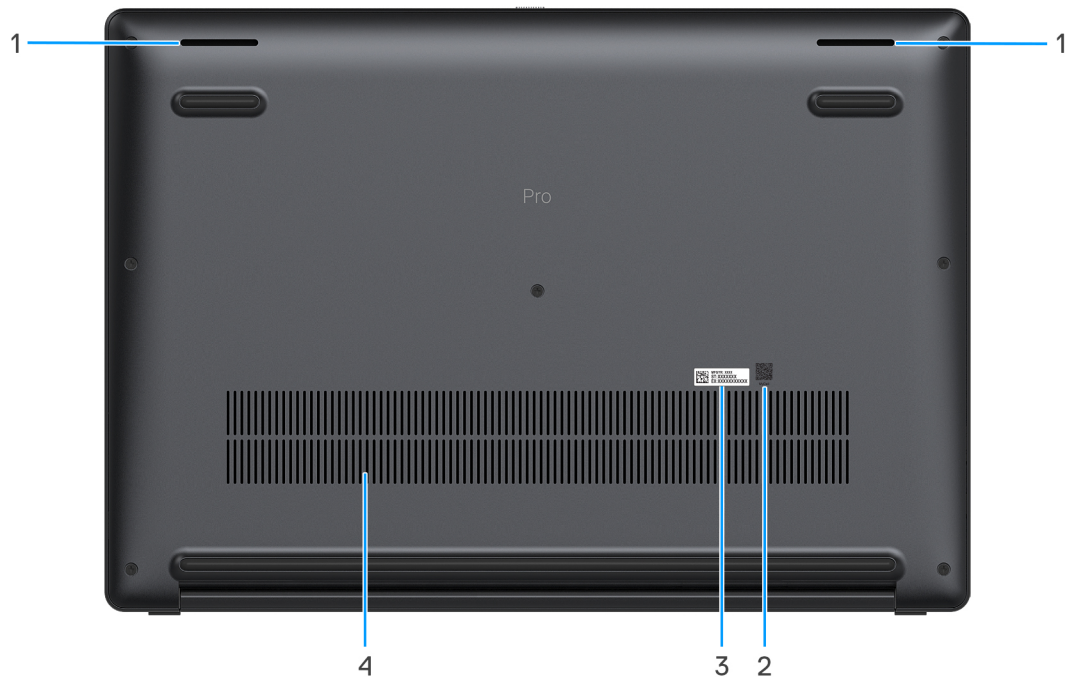

Figure 6. Bottom view

1. Speakers

Provide audio output.

2. MyDell QR code

MyDell is your hub for content personalized to your Dell Pro 13 Premium PA13250, including videos, articles, manuals, and access to support.

3. Service Tag label

The Service Tag is a unique alphanumeric identifier that enables Dell service technicians to identify the hardware components in your computer and access warranty information. The Express Service Code is a numeric version of the Service Tag.

4. Air vents

Air vents provide ventilation for your computer. Clogged air vents can cause overheating and can affect your computer's performance and potentially cause hardware issues. Keep the air vents clear of obstructions and clean them regularly to prevent the build-up of dust and dirt. For more information about cleaning air vents, search for articles in the Knowledge Base Resource at the [Dell Support site](#).

Locate the Service Tag or Express Service Code label of your computer

The service tag is a unique alphanumeric identifier that allows Dell service technicians to identify the hardware components in your computer and access warranty information. The Express Service Code is a numeric version of the Service Tag.

For more information about how to find the Service Tag of your computer, search in the Knowledge Base Resource at the [Dell Support Site](#).



Figure 7. Service Tag/Express Service Code location

Battery-charge status light

The following table lists the battery-charge status light of your Dell Pro 13 Premium PA13250.

Table 1. Battery charge and status light behavior

Power source	LED behavior	System power state	Battery charge level
AC adapter	Off	S0 or S5	Fully charged
AC adapter	Solid white	S0 or S5	< Fully charged
Battery	Off	S0 or S5	11-100%
Battery	Solid amber (590+/-3 nm)	S0 or S5	< 10%

- S0 (ON): Computer is turned on.
- S4 (Hibernate): The computer consumes the least power in the Hibernate state than in the ON or OFF state. The computer is almost in the OFF state. The context data is written to a storage device, allowing you to resume from where you left when the computer is turned on.
- S5 (OFF): The computer is in a shutdown state.

Set up your Dell Pro 13 Premium PA13250

About this task

NOTE: The images in this document may differ from your computer depending on the configuration you ordered.

Steps

1. Connect the power adapter and press the power button.



Figure 8. Connect the power adapter and press the power button.

NOTE: The battery may go into power-saving mode during shipment to conserve charge on the battery. Ensure that the power adapter is connected to your computer when it is turned on for the first time.

2. Finish the operating system setup.

For Ubuntu:

Follow the on-screen instructions to complete the setup. For more information about installing and configuring Ubuntu, search in the Knowledge Base Resource at [Dell Support Site](#).

For Windows:

Follow the on-screen instructions to complete the setup. When setting up, it is recommended that you:





- Connect to a network for Windows updates.

NOTE: If connecting to a secured wireless network, enter the password for the wireless network access when prompted.

- If connected to the Internet, sign-in with an existing Microsoft account or create a new account.

3. Locate and use Dell apps from the Windows Start menu—Recommended.

Table 2. Locate Dell apps

Resources	Description
	<p>Dell Product Registration Register your computer with Dell.</p>
	<p>Dell Help & Support Access help and support for your computer.</p>
	<p>SupportAssist SupportAssist keeps your computer running at its best by optimizing settings, detecting issue, and removing viruses. It also notifies when updates are available for your computer. SupportAssist proactively checks the health of your computer hardware and software. When an issue is detected, the necessary system state information is sent to Dell to begin troubleshooting. SupportAssist is preinstalled on most of the Dell devices running the Windows operating system. For more information, see Support Assist documentation at Dell Support Site.</p> <p>NOTE: In SupportAssist, click the warranty expiry date to renew or upgrade your warranty.</p>
	<p>Dell Command Update Updates your computer with critical fixes and latest device drivers as they become available. For more information about using Dell Command Update, see the product guides and third-party license documents at Dell Support Site.</p>
	<p>Dell Digital Delivery Download software applications, which are purchased but not preinstalled on your computer. For more information about using Dell Digital Delivery, search in the Knowledge Base Resource at Dell Support Site.</p>

Specifications of Dell Pro 13 Premium PA13250

Dimensions and weight

The following table lists the height, width, depth, and weight of your Dell Pro 13 Premium PA13250.

Table 3. Dimensions and weight

Description	Values
Height:	
Front height	16.55 mm (0.65 in.)
Rear height	17.19 mm (0.68 in.)
Width	296.00 mm (11.63 in.)
Depth	208.90 mm (8.23 in.)
Weight (Minimum)	1.07 kg (2.36 lbs)
 NOTE: The weight of your computer depends on the configuration that is offered.	

Processor

The following table lists the details of the processors that are supported in your Dell Pro 13 Premium PA13250.

Table 4. Processor

Description	Option one	Option two	Option three	Option four
Processor type	Intel Core Ultra 5 236V vPro Enterprise	Intel Core Ultra 5 238V vPro Enterprise	Intel Core Ultra 7 266V vPro Enterprise	Intel Core Ultra 7 268V vPro Enterprise
Processor wattage	17 W	17 W	17 W	17 W
Processor core count	8	8	8	8
Processor thread count	8	8	8	8
Processor speed	up to 4.7 GHz	up to 4.7 GHz	up to 5 GHz	up to 5 GHz
Processor cache	8 MB	8 MB	12 MB	12 MB
Integrated graphics	Intel Arc Graphics 130V	Intel Arc Graphics 130V	Intel Arc Graphics 140V	Intel Arc Graphics 140V

Chipset

The following table lists the details of the chipset that is supported in your Dell Pro 13 Premium PA13250.

Table 5. Chipset

Description	Values
Chipset	Integrated in the processor
Processor	Intel Core Ultra 5/7
DRAM bus width	64-bit
Flash EPROM	64 MB
PCIe bus	up to Gen4

Operating system

Your Dell Pro 13 Premium PA13250 supports the following operating systems:

- Windows 11 24H2
- Windows 11 23H2
- Windows 10 22H2
- Ubuntu Linux 24.04

NOTE: Windows 10 22H2 is only for custom configured computers downgraded by end users from Windows 11. Windows 10 22H2 downgraded installations are supported by customer internal IT and is subjected to the Microsoft Windows 10 End of Support plan.

Memory

The following table lists the memory specifications of your Dell Pro 13 Premium PA13250.

Table 6. Memory specifications

Description	Values
Memory slots	Onboard memory
Memory type	LPDDR5x
Memory speed	8533 MT/s
Maximum memory configuration	32 GB
Minimum memory configuration	16 GB
Memory configurations supported	<ul style="list-style-type: none">• 16 GB, 1 x 16 GB, LPDDR5x, 8533 MT/s• 32 GB, 1 x 32 GB, LPDDR5x, 8533 MT/s

External ports and slots

The following table lists the external ports and slots of your Dell Pro 13 Premium PA13250.

Table 7. External ports and slots

Description	Values
USB ports	<ul style="list-style-type: none">One USB 3.2 Gen 1 (5 Gbps) with PowerShare port
Audio port	One universal audio port
Video port(s)	<ul style="list-style-type: none">Two Thunderbolt 4 (40 Gbps) with DisplayPort Alt Mode/USB Type-C/USB4/Power Delivery portsOne HDMI 2.1 port
Media-card reader	Not supported
Power-adaptor port	Supported through the Thunderbolt 4 ports available on the computer
Security-cable slot	One wedge-shaped security slot
SIM-card slot	One nano-SIM card slot (optional)

Internal slots

The following table lists the internal slots of your Dell Pro 13 Premium PA13250.

Table 8. Internal slots

Description	Values
M.2	<ul style="list-style-type: none">One M.2 2230 slot for solid-state driveOne M.2 3052 slot for 5G WWAN card <p> NOTE: To learn more about the features of different types of M.2 cards, search in the Knowledge Base Resource at Dell Support Site.</p>

Wireless module

The following table lists the Wireless Local Area Network (WLAN) module that is supported on your Dell Pro 13 Premium PA13250.

Table 9. Wireless module specifications

Description	Values
Model number	Intel WiFi 7 BE201
Transfer rate	5670 Mbps
Frequency bands supported	2.40 GHz/5 GHz/6 GHz
Wireless standards	<ul style="list-style-type: none">WiFi 802.11a/b/gWi-Fi 4 (WiFi 802.11n)Wi-Fi 5 (WiFi 802.11ac)

Table 9. Wireless module specifications (continued)

Description	Values
	<ul style="list-style-type: none"> • Wi-Fi 6E (WiFi 802.11ax) • Wi-Fi 7 (WiFi 802.11be)
Encryption	<ul style="list-style-type: none"> • 64-bit/128-bit WEP • AES-CCMP • TKIP
Bluetooth wireless card	Bluetooth 5.4

WWAN module

The following table lists the Wireless Wide Area Network (WWAN) module that is supported in your Dell Pro 13 Premium PA13250.

 **NOTE:** The WWAN module is available only on certain configurations and in certain regions.

 **NOTE:** Availability of the eSIM feature on this module depends your region.



 **NOTE:** For instructions on how to setup SIM or eSIM connections on your computer, see the *SIM/eSIM Setup Guide for Windows* available with your product documentation at [Dell Support Site](#).

Table 10. WWAN module specifications

Description	Values
Model number	Qualcomm Snapdragon X72 Global 5G Modem (DW5934e)
Form factor	M.2 3052 Key-B
Host interface	PCIe Gen3
Network standard	NR FR1(Sub6) FDD/TDD, LTE FDD/TDD, WCDMA/HSPA+, GPS/GLONASS/Galileo/Beidou
Transfer data rate	<ul style="list-style-type: none"> • 5G NR: DL 4.14Gbps/UL 900Mbps • LTE: DL 2.0Gbps (CAT20)/UL 211Mbps (CAT18) • UMTS: DL DC-HSPA+ Rel8:42 Mbps/UL 5.76 Mbps
Operating frequency bands	<ul style="list-style-type: none"> • NR(n1, n2, n3, n5, n7, n8, n12, n13, n14, 18, n20, n25, n26, n28, n29, n30, n38, n40, n41, n48, n66, n67, n70, n71, n75, n76, n77, n78, n79, n91, n92, n93, n94) • LTE (B1, B2, B3, B4, B5, B7, B8, B12, B13, B14, B17, B18, B19, B20, B25, B26, B28, B29, B30, B32, B34, B38, B39, B40, B41, B42, B43, B46, B48, B66, B67, B68, B70, B71) • WCDMA/HSPA+ (1, 2, 4, 5, 8)
Power supply	DC 3.135V to 3.63V, typical 3.3V
SIM card	Supported through external SIM slot
eSIM with dual SIM (DSSA)	Supported
Antenna diversity	Supported
Radio on/off	Supported

Table 10. WWAN module specifications (continued)

Description	Values
Wake On Wireless	Supported in Morden Standby mode
Temperature	<ul style="list-style-type: none"> Normal operating temperature: –30°C to +70°C Extended operating temperature: –40°C to +85°C Storage temperature: –40°C to +85°C
Antenna connector	<ul style="list-style-type: none"> WWAN Main Antenna x 1 WWAN Diversity Antenna x 1 4x4 MIMO Antenna x 2
 NOTE: For instructions to find your computer's International Mobile Equipment Identity (IMEI) number, search in the Knowledge Base Resource at Dell Support Site .	

Audio

The following table lists the audio specifications of your Dell Pro 13 Premium PA13250.

Table 11. Audio specifications

Description	Values	
Audio controller	Cirrus CS42L43 and Cirrus CS35L56	
Stereo conversion	Supported	
Internal audio interface	High-definition audio	
External audio interface	Universal audio port	
Number of speakers	Four	
Internal-speaker amplifier	Supported (audio codec integrated)	
External volume controls	Keyboard shortcut controls	
Speaker output:		
	Average	2 W
	Peak	2.5 W
Microphone	Digital-array microphones in camera assembly	

Storage

This section lists the storage options on your Dell Pro 13 Premium PA13250.

Your computer supports the following storage configuration:

- One M.2 2230 solid-state drive

The M.2 2230 solid-state drive is the primary drive of your computer.

Table 12. Storage specifications

Storage type	Interface type	Capacity
M.2 2230 solid state drive, Class 35	TLC PCIe Gen4 NVMe	256 GB/512 GB/1 TB

Table 12. Storage specifications (continued)

Storage type	Interface type	Capacity
M.2 2230 solid-state drive, Self-encrypting drive, Opal 2.0, Class 35	TLC PCIe Gen4 NVMe	512 GB
M.2 2230 solid state drive, Class 25	QLC PCIe Gen4 NVMe	2 TB

Keyboard

The following table lists the keyboard specifications of your Dell Pro 13 Premium PA13250.

Table 13. Keyboard specifications

Description	Values
Keyboard type	Battery-saving mini LED backlit zero-lattice keyboard
Keyboard layout	QWERTY
Number of keys	<ul style="list-style-type: none"> English US, English International, Arabic, Canada bilingual (MUI), Chinese traditional, French-Canadian, Greek, Hebrew, Korean, Russian, Thai, Ukrainian: 79 keys French-Canadian Quebec, Belgian, Bulgarian, Czech & Slovakian (MUI), Danish, English UK, Estonian, French European, German, Hungarian, Icelandic, Italian, Nordic (MUI), Norwegian, Portugese Iberian, Slovenian, Spanish (Castillian), Spanish (Latin America), Swedish/Finnish, Swiss European (MUI), Turkish, Turkish (F): 80 keys Japanese: 83 keys Portuguese Brazilian: 81 keys
Keyboard size	X=18.05 mm key pitch Y=18.05 mm key pitch
Keyboard shortcuts	<p>Some keys on your keyboard have two symbols on them. These keys can be used to type alternate characters or to perform secondary functions. To type the alternate character, press Shift and the desired key. To perform secondary functions, press Fn and the desired key.</p> <p>NOTE: You can define the primary behavior of the function keys (F1–F12) changing Function Key Behavior in the BIOS setup program.</p> <p>NOTE: If Copilot in Windows is not available on your computer, pressing the Copilot key launches Windows search. For more information about Copilot in Windows, search in the Knowledge Base Resource at the Dell Support site.</p>

Keyboard shortcuts of Dell Pro 13 Premium PA13250

NOTE: Keyboard characters may differ depending on the keyboard language configuration. Keys that are used for shortcuts remain the same across all language configurations.

Some keys on your keyboard have two symbols on them. These keys can be used to type alternate characters or to perform secondary functions. The symbol that is shown on the lower part of the key refers to the character that is typed out when the

key is pressed. If you press shift and the key, the symbol that is shown on the upper part of the key is typed out. For example, if you press **2**, 2 is typed out; if you press **Shift + 2**, @ is typed out.

The keys F1-F12 at the top row of the keyboard are function keys for multimedia control, as indicated by the icon on the key. Press the function key to enable the task represented by the icon. For example, pressing F1 mutes the audio (see the table below).

However, if the function keys F1-F12 are needed for specific software applications, multimedia functionality can be disabled by pressing **Fn + Esc**. Later, multimedia control can be invoked by pressing **Fn** and the respective function key. For example, mute audio by pressing **Fn + F1**.

 **NOTE:** You can also define the primary behavior of the function keys (F1–F12) by changing **Function Key Behavior** in the BIOS setup program.

Table 14. Function key primary behavior

Function key	Primary behavior
F1	Mute or unmute audio
F2	Decrease volume
F3	Increase volume
F4	Microphone Mute
F5	KB Illumination/Backlight
F6	Decrease brightness
F7	Increase brightness
F8	Switch to external display
F9	Stealth mode
F10	Print screen
F11	Home
F12	End

The **Fn** key is also used with selected keys on the keyboard to invoke secondary functions.

Table 15. Secondary behavior

Function key	Secondary behavior
Fn + F1	Operating system and application-specific F1 behavior
Fn + F2	Operating system and application-specific F2 behavior
Fn + F3	Operating system and application-specific F3 behavior
Fn + F4	Operating system and application-specific F4 behavior
Fn + F5	Operating system and application-specific F5 behavior
Fn + F6	Operating system and application-specific F6 behavior
Fn + F7	Operating system and application-specific F6 behavior
Fn + F8	Operating system and application-specific F8 behavior
Fn + F9	Operating system and application-specific F9 behavior
Fn + F10	Operating system and application-specific F10 behavior
Fn + F11	Operating system and application-specific F11 behavior
Fn + F12	Operating system and application-specific F12 behavior
Fn + Ctrl	Open the application menu
Fn + Esc	Toggle between multimedia and function key behavior

Table 15. Secondary behavior (continued)

Function key	Secondary behavior
Fn + PgUp	Scroll up the document or page
Fn + PgDn	Scroll down the document or page
Fn + Home	Move to the beginning of the document
Fn + End	Move to the end of the document
Copilot	<p>Launch Copilot in Windows</p> <p>NOTE: If Copilot in Windows is not available on your computer, the Copilot key launches Recall. If both Recall and Copilot in Windows are not available on your computer, the Copilot key launches Windows Search. For more information about Copilot in Windows and Recall, search in the Knowledge Base Resource at the Dell Support Site.</p>

Camera

The following table lists the camera specifications of your Dell Pro 13 Premium PA13250.

Table 16. Camera specifications

Description	Values
Number of cameras	Two
Camera type	<p>There are 2 camera options:</p> <ul style="list-style-type: none"> • IR Camera • IR Camera with Presence Detection (Synaptics)
Camera location	Front camera
Camera sensor type	CMOS sensor technology
Camera resolution:	
Still image	8.0 megapixel
Video	<p>2560 x 1440 at 30 fps</p> <p>NOTE: The default resolution for video is set at 1080p. For more information about changing the camera resolution, search for information about changing the camera resolution in Windows 11 at the Microsoft Support Site.</p>
Infrared camera resolution:	
Still image	0.23 megapixel
Video	640 x 360 at 30 fps
Diagonal viewing angle:	
Camera	88.1 degrees
Infrared camera	86.6 degrees

Touchpad

The following table lists the touchpad specifications of your Dell Pro 13 Premium PA13250.

Table 17. Touchpad specifications

Description	Values
Touchpad resolution:	>300 dpi
Touchpad dimensions:	
Horizontal	125 mm (4.92 in.)
Vertical	71 mm (2.79 in.)
Touchpad gestures	For more information about the touchpad gestures available on Windows, see the Microsoft Knowledge Base article at Microsoft Support Site .

Touchpad with collaboration controls (optional)

The following table lists the touchpad specifications of your Dell Pro 13 Premium PA13250 (for computers shipped with Collaboration Touchpad).

Table 18. Touchpad specifications

Description	Values
Touchpad type	Collaboration Touchpad
Collaboration controls on touchpad	Four controls are available to control video, share screen, chat, and mute functions during conference calls. The controls are visible on the touchpad during any conference calls. Compatible with Zoom and Teams for work or school.
Collaboration controls settings	<ul style="list-style-type: none"> Control brightness manually or configure icon brightness to automatically adjust to the ambient light. Customize settings to activate collaboration controls with a single tap or a double tap. Customize specific controls to be activated or deactivated.
Collaboration controls functionality	<p>Video icon: Turn on or off the camera.</p> <ul style="list-style-type: none"> White icon: The camera is turned on. Red icon: The camera is off. <p>Share screen icon: Tap once to share your screen. Tap again to stop sharing.</p> <p>Chat icon: Show or hide the chat window. The icon blinks when you receive a new chat message.</p> <p>Microphone icon: Turn on or mute the microphone.</p> <ul style="list-style-type: none"> White icon: The microphone is turned on. Red icon: The microphone is muted.
Required apps for collaboration controls	<ul style="list-style-type: none"> Dell Optimizer Version 4.2.0.0 and higher Zoom Client Version 5.9.3 and higher Teams for work or school (Windows desktop) Version 1.6.00.24078 and higher
Touchpad resolution:	
Horizontal	>300 dpi

Table 18. Touchpad specifications (continued)

Description		Values
	Vertical	Not supported
Touchpad dimensions:		
	Horizontal	125 mm (4.92 in.)
	Vertical	71 mm (2.79 in.)
Touchpad gestures		For more information about touchpad gestures available on Windows, see the Microsoft Knowledge Base article at Microsoft Support Site .
<p>i NOTE: To enjoy the collaboration touchpad (CTP) controls feature on your keyboard, ensure that you have the latest versions of the Dell Optimizer app and Zoom or Teams for work or school that is installed on your computer. Dell Optimizer offers a modular installation which allows you to select the modules you want to install. Install the collaboration touchpad module within the Dell Optimizer app to enjoy the functionality of collaboration controls. For more information, search for <i>Dell Optimizer</i> in the Knowledge Base Resource at the Dell Support Site.</p> <p>i NOTE: For more information about how to configure and use your collaboration controls, search for the Collaboration Touchpad Reference Guide in the Knowledge Base Resource at Dell Support Site. Or, watch the video at Dell Collaboration Touchpad.</p> <p>i NOTE: Collaboration Touchpad is supported only on Teams for work or school (Windows desktop) application. Teams for home and Teams on web are not supported.</p>		

Power adapter

The following table lists the power adapter specifications of your Dell Pro 13 Premium PA13250.

Table 19. Power-adapter specifications

Description	Option one	Option two	Option three
Type	60W AC ultralight mini adapter, USB Type-C	65 W AC adapter, USB Type-C	100 W AC adapter, USB Type-C
Power-adapter dimensions:			
Height	22 mm (0.86 in)	28 mm (1.10 in)	26.50 mm (1.04 in)
Width	55 mm (2.16 in.)	51 mm (2.01 in.)	60.00 mm (2.36 in.)
Depth	66 mm (2.59 in.)	112 mm (4.41 in.)	122.00 mm (4.80 in.)
Input voltage	100 VAC to 240 VAC	100 VAC to 240 VAC	100 VAC to 240 VAC
Input frequency	50 Hz to 60 Hz	50 Hz to 60 Hz	50 Hz to 60 Hz
Input current (maximum)	1.7 A	1.7 A	1.7 A
Output current (continuous)	<ul style="list-style-type: none"> ● 20 V/3 A ● 15 V/3 A ● 9 V/3 A ● 5 V/3 A 	<ul style="list-style-type: none"> ● 20 V/3.25 A ● 15 V/3 A ● 9 V/3 A ● 5 V/3 A 	<ul style="list-style-type: none"> ● 20 V/5 A ● 15 V/3 A ● 9 V/3 A ● 5 V/3 A
Rated output voltage	<ul style="list-style-type: none"> ● 20 VDC ● 15 VDC ● 9 VDC ● 5 VDC 	<ul style="list-style-type: none"> ● 20 VDC ● 15 VDC ● 9 VDC ● 5 VDC 	<ul style="list-style-type: none"> ● 20 VDC ● 15 VDC ● 9 VDC ● 5 VDC

Table 19. Power-adapter specifications (continued)





Description	Option one	Option two	Option three
Temperature range:			
Operating	0°C to 40°C (32°F to 104°F)	0°C to TBD°C (32°F to TBD°F)	0°C to 40°C (32°F to 104°F)
Storage	-40°C to 70°C (-40°F to 158°F)	-40°C to 70°C (-40°F to 158°F)	-40°C to 70°C (-40°F to 158°F)
 CAUTION: Operating and storage temperature ranges may differ among components, so operating or storing the device outside these ranges may impact the performance of specific components.			

Power adapter requirements of Dell Pro 13 Premium PA13250 (for computers shipped with 2-cell, 40 Wh battery)

 **NOTE:** If you did not purchase the Dell-branded power adapter that is recommended for your computer, ensure that the power adapter you use meets the following requirements.

The following table lists the power adapter requirements for your Dell Pro 13 Premium PA13250 (for computers that are shipped with 2-cell, 40 Wh battery).

Table 20. Power adapter requirements

Description	Value
Power that is required from a power adapter to achieve optimal performance	100 W
Power that charges the computer at a slower speed  NOTE: A warning message may appear informing you about the use of a lower-powered adapter and slower charging speed.	Less than 100 W
Minimum power that is required from a power adapter to operate the computer and charge the battery  NOTE: A warning message appears informing you about the use of a lower-powered adapter and slower charging speed.	27 W
USB Power Delivery (PD) fast charging	Supported
ExpressCharge mode	Supported  NOTE: Ensure that the computer is connected to a 100 W power adapter for this feature to be supported.  NOTE: ExpressCharge mode must also be enabled in the BIOS Setup screen. Select Power > Battery Configuration > ExpressCharge , then press Enter .

Power adapter requirements of Dell Pro 13 Premium PA13250 (for computers shipped with 3-cell, 60 Wh battery)

 **NOTE:** If you did not purchase the Dell-branded power adapter that is recommended for your computer, ensure that the power adapter you use meets the following requirements.

The following table lists the power adapter requirements for your Dell Pro 13 Premium PA13250 (for computers that are shipped with 3-cell, 60 Wh battery).

Table 21. Power adapter requirements

Description	Value
Power that is required from a power adapter to achieve optimal performance	100 W
Power that charges the computer at a slower speed i NOTE: A warning message may appear informing you about the use of a lower-powered adapter and slower charging speed.	Less than 100 W
Minimum power that is required from a power adapter to operate the computer and charge the battery i NOTE: A warning message appears informing you about the use of a lower-powered adapter and slower charging speed.	27 W
USB Power Delivery (PD) fast charging	Supported
ExpressCharge mode	Supported i NOTE: Ensure that the computer is connected to a 100 W power adapter for this feature to be supported. i NOTE: ExpressCharge mode must also be enabled in the BIOS Setup screen. Select Power > Battery Configuration > ExpressCharge , then press Enter .



Battery

The following table lists the battery specifications of your Dell Pro 13 Premium PA13250.

Table 22. Battery specifications

Description	Option one	Option two	Option three	Option four
Battery type	2-cell, 40 Wh, Lithium Ion, ExpressCharge 2.0, ExpressCharge Boost	2-cell, 40 Wh, Lithium Ion, ExpressCharge 2.0, ExpressCharge Boost, Long Life Cycle	3-cell, 60 Wh, Lithium Ion, ExpressCharge, ExpressCharge Boost	3-cell, 60 Wh, Lithium Ion, ExpressCharge, ExpressCharge Boost, Long Life Cycle
Battery voltage	7.80 VDC	7.80 VDC	11.70 VDC	11.70 VDC
Battery weight (maximum)	155 gm	155 gm	215 gm	215 gm
Battery dimensions:				
Height	6.15 mm (0.24 in.)	6.15 mm (0.24 in.)	6.15 mm (0.24 in.)	6.15 mm (0.24 in.)
Width	248 mm (9.76 in.)	248 mm (9.76 in.)	248 mm (9.76 in.)	248 mm (9.76 in.)
Depth	65.10 mm (2.56 in.)	65.10 mm (2.56 in.)	65.10 mm (2.56 in.)	65.10 mm (2.56 in.)
Temperature range:				
Operating	0°C to 60°C (32°F to 140°F)	0°C to 60°C (32°F to 140°F)	0°C to 60°C (32°F to 140°F)	0°C to 60°C (32°F to 140°F)
Storage	-20°C to 60°C (-4°F to 140°F)	-20°C to 60°C (-4°F to 140°F)	-20°C to 60°C (-4°F to 140°F)	-20°C to 60°C (-4°F to 140°F)
Battery operating time	Varies depending on operating	Varies depending on operating	Varies depending on operating conditions and	Varies depending on operating conditions and

Table 22. Battery specifications (continued)

Description	Option one	Option two	Option three	Option four
<p>Battery charging time (approximate)</p> <p> NOTE: You can control the charging time, duration, start and end time, and so on, using the settings on the MyDell application (Power option). For more information about MyDell application, search in the Knowledge Base Resource at Dell Support Site.</p>	<p>conditions and can significantly reduce under certain power-intensive conditions.</p> <p>Express Charge Method:</p> <ul style="list-style-type: none"> 0 - 15°C maximum allowable charge time from 0 to 100% RSOC is 4 hours 16 - 45°C normal express charge 46 - 50°C maximum allowable charge time from 0 to 100% RSOC is 3 hours <p>Standard Charge/Predominately AC User Charge Method:</p> <ul style="list-style-type: none"> 0 - 15°C maximum allowable charge time from 0 to 100% RSOC is 4 hours 16 - 50°C maximum allowable charge time from 0 to 100% RSOC is 3 hours <p>Express Charge Boost Charge Method (Fast Charge for Initial 35%):</p> <ul style="list-style-type: none"> 16 - 45°C target charge time from 0 to 35% RSOC is 20 mins for Accelerated Charge 	<p>conditions and can significantly reduce under certain power-intensive conditions.</p> <p>Express Charge Method:</p> <ul style="list-style-type: none"> 0 - 15°C maximum allowable charge time from 0 to 100% RSOC is 4 hours 16 - 45°C normal express charge 46 - 50°C maximum allowable charge time from 0 to 100% RSOC is 3 hours <p>Standard Charge/Predominately AC User Charge Method:</p> <ul style="list-style-type: none"> 0 - 15°C maximum allowable charge time from 0 to 100% RSOC is 4 hours 16 - 50°C maximum allowable charge time from 0 to 100% RSOC is 3 hours <p>Express Charge Boost Charge Method (Fast Charge for Initial 35%):</p> <ul style="list-style-type: none"> 16 - 45°C target charge time from 0 to 35% RSOC is 20 mins for Accelerated Charge 	<p>can significantly reduce under certain power-intensive conditions.</p> <p>Express Charge Method:</p> <ul style="list-style-type: none"> 0 - 15°C maximum allowable charge time from 0 to 100% RSOC is 4 hours 16 - 45°C normal express charge 46 - 50°C maximum allowable charge time from 0 to 100% RSOC is 3 hours <p>Standard Charge/Predominately AC User Charge Method:</p> <ul style="list-style-type: none"> 0 - 15°C maximum allowable charge time from 0 to 100% RSOC is 4 hours 16 - 50°C maximum allowable charge time from 0 to 100% RSOC is 3 hours <p>Express Charge Boost Charge Method (Fast Charge for Initial 35%):</p> <ul style="list-style-type: none"> 16 - 45°C target charge time from 0 to 35% RSOC is 20 mins for Accelerated Charge 	<p>can significantly reduce under certain power-intensive conditions.</p> <p>Express Charge Method:</p> <ul style="list-style-type: none"> 0 - 15°C maximum allowable charge time from 0 to 100% RSOC is 4 hours 16 - 45°C normal express charge 46 - 50°C maximum allowable charge time from 0 to 100% RSOC is 3 hours <p>Standard Charge/Predominately AC User Charge Method:</p> <ul style="list-style-type: none"> 0 - 15°C maximum allowable charge time from 0 to 100% RSOC is 4 hours 16 - 50°C maximum allowable charge time from 0 to 100% RSOC is 3 hours <p>Express Charge Boost Charge Method (Fast Charge for Initial 35%):</p> <ul style="list-style-type: none"> 16 - 45°C target charge time from 0 to 35% RSOC is 20 mins for Accelerated Charge
Coin-cell battery	Not Supported	Not Supported	Not Supported	Not Supported
<p> CAUTION: Operating and storage temperature ranges may differ among components, so operating or storing the device outside these ranges may impact the performance of specific components.</p> <p> CAUTION: Dell Technologies recommends that you charge the battery regularly for optimal power consumption.</p>				

Display

The following table lists the display specifications of your Dell Pro 13 Premium PA13250.

Table 23. Display specifications

Description		Option one	Option two	Option three
Display type		Full High Definition Plus (FHD+)	Full High Definition Plus (FHD+), Battery saving, ComfortView Plus	Quad High Definition Plus (QHD+), Battery saving, ComfortView Plus
Touch options		No	No	Yes
Display-panel technology		Wide-viewing angle (WVA/IPS)	Wide-viewing angle (WVA/IPS)	Wide-viewing angle (WVA/IPS)
Display-panel dimensions (active area):				
	Height	178.78 mm	178.78 mm	178.80 mm
	Width	286.04 mm	286.04 mm	286.08 mm
	Diagonal	337.31 mm	337.31 mm	337.36 mm
Display-panel native resolution		1920 x 1200	1920 x 1200	2560 x 1600
Luminance (typical)		300 nits	400 nits	500 nits
Megapixels		8.0	8.0	8.0
Color gamut		45% NTSC	100% sRGB	100% sRGB
Pixels Per Inch (PPI)		170 ppi	170 ppi	227 ppi
Contrast ratio (typical)		800:1	1500:1	1500:1
Response time (maximum)		35 ms	35 ms	35 ms
Refresh rate		48 Hz to 60 Hz	30 Hz to 60 Hz	48 Hz to 60 Hz
Horizontal view angle		+/- 85 degrees (typ.)	+/- 85 degrees (typ.)	+/- 85 degrees (typ.)
Vertical view angle		+/- 85 degrees (typ.)	+/- 85 degrees (typ.)	+/- 85 degrees (typ.)
Pixel pitch		0.14 mm x 0.14 mm	0.14 x 0.14 mm	0.11 x 0.11 mm
Power consumption (maximum)		3.77 W	2.45 W	3.28 W
Anti-glare vs glossy finish		Anti-glare	Anti-glare	Anti-reflection/Anti-smudge

Fingerprint reader (optional)

The following table lists the specifications of the optional fingerprint-reader of your Dell Pro 13 Premium PA13250.

 **NOTE:** The fingerprint reader is on the power button.

Table 24. Fingerprint reader specifications

Description	Values
Sensor technology	Trans-capacitive sensing
Sensor resolution	500 dpi
Sensor pixel size	<ul style="list-style-type: none"> • X: 108 • Y: 88

Sensor

The following table lists the sensor of your Dell Pro 13 Premium PA13250.

Table 25. Sensor

Sensor support
Accelerometer (ST Micro LIS2DW12TR): On the base of the system board
Accelerometer (ST Micro LNG2DMTR-GP): On the hinge-up midboard in the upsell configuration for a clamshell computer with MIPI RGB+IR camera
Ambient Light Sensor (optional)
Proximity for SAR compliance (for the WWAN module) Near Field Proximity Sensor
Hall Effect Sensor
Sensor Hub (integrated)

GPU—Integrated

The following table lists the specifications of the integrated Graphics Processing Unit (GPU) supported by your Dell Pro 13 Premium PA13250.

Table 26. GPU—Integrated

Controller	Memory size	Processor
Intel Arc Graphics 130V	Shared system memory	Intel Core Ultra 5
Intel Arc Graphics 140V	Shared system memory	Intel Core Ultra 7

Multiple display support matrix

The following table lists the multiple display support matrix for your Dell Pro 13 Premium PA13250.

Table 27. Multiple display support matrix

Graphics Card	Direct Graphics Controller Direct Output Mode	Supported external displays with computer internal display on	Supported external displays with computer internal display off
Intel Arc Graphics	Not applicable	3	4

Hardware security

The following table lists the hardware security of your Dell Pro 13 Premium PA13250.

Table 28. Hardware security

Hardware security
Trusted Platform Module (TPM) 2.0 discrete
FIPS 140-2 certification for TPM
Trusted Computing Group (TCG) Certification for TPM
SED SSD NVMe, SSDSSD (Opal and non-Opal) per SDL
One wedge-shaped lock slot
SED (Opal 2.0 only - PCIe Interface)
Windows Hello - Fingerprint Reader (optional)
Mechanical privacy shutter for camera (only for metal laptops)
Chassis Intrusion Detection

Operating and storage environment

This table lists the operating and storage specifications of your Dell Pro 13 Premium PA13250.

Airborne contaminant level: G1 as defined by ISA-S71.04-1985

Table 29. Computer environment

Description	Operating	Storage
Temperature range	0°C to 35°C (32°F to 95°F)	-40°C to 65°C (-40°F to 149°F)
Relative humidity (maximum)	10% to 90% (non-condensing)	0% to 95% (non-condensing)
Vibration (maximum)*	0.66 GRMS	1.30 GRMS
Shock (maximum)	110 G†	160 G†
Altitude range	-15.2 m to 3048 m (4.64 ft to 5518.4 ft)	-15.2 m to 10668 m (4.64 ft to 19234.4 ft)

CAUTION: Operating and storage temperature ranges may differ among components, so operating or storing the device outside these ranges may impact the performance of specific components.

* Measured using a random vibration spectrum that simulates the user environment.

† Measured using a 2 ms half-sine pulse.

Dell support policy

For information about Dell support policy, search in the Knowledge Base Resource at [Dell Support Site](#).

ComfortView Plus

 **WARNING: Prolonged exposure to blue light from the display may lead to long-term effects such as eye strain, eye fatigue, or damage to the eyes.**

Blue light is a color in the light spectrum which has a short wavelength and high energy. Chronic exposure to blue light, particularly from digital sources may disrupt sleep patterns and cause long-term effects such as eye strain, eye fatigue, or damage to the eyes.

The display on this computer is designed to minimize blue light and complies with TÜV Rheinland's requirement for low blue light displays.

Low blue light mode is enabled at the factory, so no further configuration is necessary.

To reduce the risk of eye strain, it is also recommended that you:

- Position the display at a comfortable viewing distance between 20 and 28 inches (50 cm and 70 cm) from your eyes.
- Blink frequently to moisten your eyes, wet your eyes with water, or apply suitable eye drops.
- Take an extended break for 20 minutes every two hours.
- Look away from your display, and gaze at a distant object at 20 ft (609.60 cm) away for at least 20 seconds during each break.

Dell Optimizer

Dell Optimizer is an AI-based software application that allows you to customize your computer settings for power and battery, collaboration touchpad, and more.

For Dell Pro 13 Premium PA13250 with Dell Optimizer, you can:









- Extend the battery life of your computer with Intelligent Battery Extender and Dynamic Charge.
- Tune the performance, power consumption, cooling, and fan noise with selectable thermal modes.
- Access Zoom and Microsoft Teams meeting controls with the Collaboration Touchpad.
- Access and secure your computer depending on your physical presence.
- Download and redeem the apps that are purchased with your computer.

For more information about configuring and using these features, search for *Dell Optimizer* at the [Dell Support Site](#).

Working inside your computer



Safety instructions

Use the following safety guidelines to protect your computer from potential damage and to ensure your personal safety. Unless otherwise noted, each procedure in this document assumes that you have read the safety information that shipped with your computer.

-  **WARNING:** Before working inside your computer, read the safety information that is shipped with your computer. For more safety best practices, see [Dell Regulatory Compliance Home Page](#).
-  **WARNING:** Disconnect your computer from all power sources before opening the computer cover or panels. After you finish working inside the computer, replace all covers, panels, and screws before connecting your computer to an electrical outlet.
-  **CAUTION:** To avoid damaging the computer, ensure that the work surface is flat, dry, and clean.
-  **CAUTION:** You should only perform troubleshooting and repairs as authorized or directed by the Dell technical support team. Damage due to servicing that is not authorized by Dell is not covered by your warranty. See the safety instructions that are shipped with the product or at [Dell Regulatory Compliance Home Page](#).
-  **CAUTION:** Before touching anything inside your computer, ground yourself by touching an unpainted metal surface, such as the metal at the back of the computer. While you work, periodically touch an unpainted metal surface to dissipate static electricity which could harm internal components.
-  **CAUTION:** To avoid damaging the components and cards, handle them by their edges, and avoid touching the pins and the contacts.
-  **CAUTION:** When you disconnect a cable, pull it by its connector or its pull tab, not the cable itself. Some cables have connectors with locking tabs or thumbscrews that you must disengage before disconnecting the cable. When disconnecting cables, keep them evenly aligned to avoid bending the connector pins. When connecting cables, ensure that the connector on the cable is correctly oriented and aligned with the port.
-  **CAUTION:** Press and eject any installed card from the media-card reader.
-  **CAUTION:** Exercise caution when handling rechargeable Li-ion batteries in laptops. Swollen batteries should not be used and should be replaced and disposed properly.

Before working inside your computer

Steps

1. Save and close all open files and exit all open applications.
2. Shut down your computer. For Windows operating system, click **Start** >  **Power** > **Shut down**.
 -  **NOTE:** If you are using a different operating system, see the documentation of your operating system for instructions.
3. Turn off all the attached peripherals.
4. Disconnect your computer from the electrical outlets.
5. Disconnect all attached network devices and peripherals, such as keyboard, mouse, and monitor from your computer.
6. Remove any media card and optical drive from your computer, if applicable.
7. Enter the Service Mode.

Service Mode

Service Mode is used to cut off power without disconnecting the battery cable from the system board before conducting repairs in the computer.

 **CAUTION:** If you are unable to turn on the computer to put it into Service Mode, proceed to disconnect the battery cable. To disconnect the battery cable, follow the steps in [Removing the battery](#).

 **NOTE:** Ensure that your computer is shut down and the power adapter is disconnected.

- a. Press and hold the B key and the power button for 3 seconds or until the Dell logo appears on the screen.
- b. Press any key to continue.
- c. If the power adapter is not disconnected, a message prompting you to disconnect the power adapter appears on the screen. Disconnect the power adapter and then press any key to enter into the Service Mode. The Service Mode process automatically skips the following step if the **Owner Tag** of the computer is not set up in advance by the user.
- d. When the **ready-to-proceed** message appears on the screen, press any key to proceed. The computer emits three short beeps and shuts down immediately.
The computer shuts down and enters the Service Mode.

Safety precautions

This section details the primary steps to be followed before performing any disassembly instructions.

Observe the following safety precautions before you perform any installation or break-fix procedures involving disassembly or reassembly:

- Turn off the computer and all attached peripherals.
- Disconnect the computer from AC power.
- Disconnect all network cables and peripherals from the computer.
- Use an ESD field service kit when working inside any to avoid electrostatic discharge (ESD) damage.
- Place the removed component on an anti-static mat after removing it from the computer.
- Wear shoes with nonconductive rubber soles to reduce the chance of getting electrocuted.
- Unplugging, pressing, and holding the power button for 15 seconds should discharge residual power in the system board.

Standby power

Dell products with standby power must be unplugged before you open the back cover. Systems that are equipped with standby power are powered while turned off. The internal power enables the computer to be remotely turned on (Wake-on-LAN) and suspended into a sleep mode and has other advanced power management features.

Bonding

Bonding is a method for connecting two or more grounding conductors to the same electrical potential. This is done by using a field service electrostatic discharge (ESD) kit. When connecting a bonding wire, ensure that it is connected to bare metal and never to a painted or nonmetal surface. Ensure that the wrist strap is secure and in full contact with your skin. Remove all jewelry, watches, bracelets, or rings before grounding yourself and the equipment.

Electrostatic discharge—ESD protection

ESD is a major concern when you handle electronic components, especially sensitive components such as expansion cards, processors, memory modules, and system boards. A slight charge can damage circuits in ways that may not be obvious, such as intermittent problems or a shortened product life span. As the industry pushes for lower power requirements and increased density, ESD protection is an increasing concern.

Two recognized types of ESD damage are catastrophic and intermittent failures.

- **Catastrophic** – Catastrophic failures represent approximately 20 percent of ESD-related failures. The damage causes an immediate and complete loss of device functionality. An example of catastrophic failure is a memory module that has received a static shock and immediately generates a "No POST/No Video" symptom with a beep code that is emitted for missing or nonfunctional memory.

- **Intermittent** – Intermittent failures represent approximately 80 percent of ESD-related failures. The high rate of intermittent failures means that most of the time when damage occurs, it is not immediately recognizable. The memory module receives a static shock, but the tracing is merely weakened and does not immediately produce outward symptoms that are related to the damage. The weakened trace may take weeks or months to melt, and in the meantime may cause degradation of memory integrity, intermittent memory errors, and so on.

Intermittent failures that are also called latent or "walking wounded" are difficult to detect and troubleshoot.

Perform the following steps to prevent ESD damage:

- Use a wired ESD wrist strap that is properly grounded. Wireless anti-static straps do not provide adequate protection. Touching the chassis before handling parts does not ensure adequate ESD protection on parts with increased sensitivity to ESD damage.
- Handle all static-sensitive components in a static-safe area. If possible, use anti-static floor pads and workbench pads.
- When unpacking a static-sensitive component from its shipping carton, do not remove the component from the anti-static packing material until you are ready to install the component. Before unwrapping the anti-static packaging, use the anti-static wrist strap to discharge the static electricity from your body. For more information about the wrist strap and ESD wrist strap tester, see [Components of an ESD Field Service Kit](#).
- Before transporting a static-sensitive component, place it in an anti-static container or packaging.

ESD Field Service kit

The unmonitored field service kit is the most commonly used service kit. Each Field Service kit includes three main components: anti-static mat, wrist strap, and bonding wire.

 **CAUTION: It is critical to keep ESD-sensitive devices away from internal parts that are insulated and often highly charged, such as plastic heat sink casings.**

Working Environment

Before deploying the ESD Field Service kit, assess the situation at the customer location. For example, deploying the kit for a server environment is different than for a desktop or laptop environment. Servers are typically installed in a rack within a data center; desktops or laptops are typically placed on office desks or cubicles. Always look for a large open flat work area that is free of clutter and large enough to deploy the ESD kit with additional space to accommodate the type of computer that is being repaired. The workspace should also be free of insulators that can cause an ESD event. On the work area, insulators such as styrofoam and other plastics should always be moved at least 12 inches or 30 centimeters away from sensitive parts before physically handling any hardware components.

ESD Packaging

All ESD-sensitive devices must be shipped and received in static-safe packaging. Metal, static-shielded bags are preferred. However, you should always return the damaged component using the same ESD bag and packaging that the new part arrived in. The ESD bag should be folded over and taped shut and all the same foam packing material should be used in the original box that the new part arrived in. ESD-sensitive devices should be removed from packaging only at an ESD-protected work surface, and parts should never be placed on top of the ESD bag because only the inside of the bag is shielded. Always place parts in your hand, on the anti-static mat, in the computer, or inside an ESD bag.

Components of an ESD Field Service kit

The components of an ESD Field Service kit are:

- **Anti-Static Mat** – The anti-static mat is dissipative and parts can be placed on it during service procedures. When using an anti-static mat, your wrist strap should be snug and the bonding wire should be connected to the anti-static mat and to any bare metal on the computer being worked on. Once deployed properly, service parts can be removed from the ESD bag and placed directly on the anti-static mat. ESD-sensitive items are safe in your hand, on the anti-static mat, in the computer, or inside an ESD bag.
- **Wrist Strap and Bonding Wire** – The wrist strap and bonding wire can be either directly connected between your wrist and bare metal on the hardware if the anti-static mat is not required, or connect to the anti-static mat to protect hardware that is temporarily placed on the mat. The physical connection of the wrist strap and bonding wire between your skin, the anti-static mat, and the hardware is known as bonding. Use only Field Service kits with a wrist strap, anti-static mat, and bonding wire. Never use wireless wrist straps. Always be cautious that the internal wires of a wrist strap are prone to

damage from normal wear and tear, and must be checked regularly with a wrist strap tester in order to avoid accidental ESD hardware damage. It is recommended to test the wrist strap and bonding wire at least once per week.

- **ESD Wrist Strap Tester** – The wires inside an ESD strap are prone to damage over time. When using an unmonitored kit, it is a best practice to regularly test the strap prior to each service, and at a minimum, test once per week. A wrist strap tester is the best method for doing this test. To perform the test, plug the bonding-wire of the wrist-strap into the tester while it is strapped to your wrist and push the button to test. A green LED is lit if the test is successful; a red LED is lit and an alarm sounds if the test fails.

 **NOTE:** It is recommended to always use the traditional wired ESD grounding wrist strap and protective anti-static mat when servicing Dell products. In addition, it is critical to keep sensitive parts separate from all insulator parts while servicing the computer.

Transporting sensitive components

When transporting ESD sensitive components such as replacement parts or parts to be returned to Dell, it is critical to place these parts in anti-static bags for safe transport.

After working inside your computer

About this task

 **CAUTION:** Leaving stray or loose screws inside your computer may severely damage your computer.

Steps

1. Replace all screws and ensure that no stray screws remain inside your computer.
2. Connect any external devices, peripherals, or cables you removed before working on your computer.
3. Replace any media cards, disks, or any other parts that you removed before working on your computer.
4. Connect your computer to their electrical outlets.

 **NOTE:** To exit service mode, ensure to connect the AC adapter to the power-adapter port on your computer.

5. Press the power button to turn on the computer.

BitLocker

 **CAUTION:** If BitLocker is not suspended before updating the BIOS, the Bitlocker key is not recognized the next time you reboot the computer. You will then be prompted to enter the recovery key to progress, and the system displays a prompt for the recovery key on each reboot. If the recovery key is not known, this can result in data loss or an operating system reinstall. For more information, see Knowledge Article: [updating the BIOS on Dell systems with BitLocker enabled](#).

The installation of the following components triggers BitLocker:

- Hard disk drive or solid-state drive
- System board

Recommended tools

The procedures in this document may require the following tools:

- Phillips screwdriver #0
- Phillips screwdriver #1
- Plastic scribe

Screw list

- NOTE:** When removing screws from a component, it is recommended to note the screw type and the quantity of screws, and then place them in a screw storage box. This is to ensure that the correct number of screws and correct screw type is restored when the component is replaced.
- NOTE:** Some computers have magnetic surfaces. Ensure that the screws are not left attached to such surfaces when replacing a component.
- NOTE:** Screw color may vary depending on the configuration ordered.

Table 30. Screw list





Component	Screw type	Quantity	Screw image
Base cover	M2.5x7 (Captive screw)	7	
Solid state drive (SSD) shield	M1.6x2 (Captive screw)	2	
WLAN bracket	M1.6x5.5 (Captive screw)	1	
Battery	M2x4.5 (Captive screw)	4	
WWAN-card bracket	M1.6x2.3 (Captive screw)	1	
Right fan	M1.6x3	2	
Left fan	M1.6x3	2	
Heat sink	M2x3.5 (Captive screw)	3	
Speaker	M2x2	6	
Left I/O-board	M1.6x5.5 M1.6x2.5	4 2	 
Right I/O-board	M1.6x5.5 M1.6x2.5	4 3	 
Left USB Type-C module	M2x5	2	
Right USB Type-C module	M2x5	2	
Power-button bracket	M1.6x2.3 (Captive screw)	1	
EDP-cable bracket	M1.6x5.5 (Captive screw)	2	

Table 30. Screw list (continued)

Component	Screw type	Quantity	Screw image
Display hinges	M2.5x5	6	
System board	M1.6x2.5	1	
Keyboard	M1.4x1.2 M1.6x2	19 8	

Major components of Dell Pro 13 Premium PA13250

The following image shows the major components of Dell Pro 13 Premium PA13250.

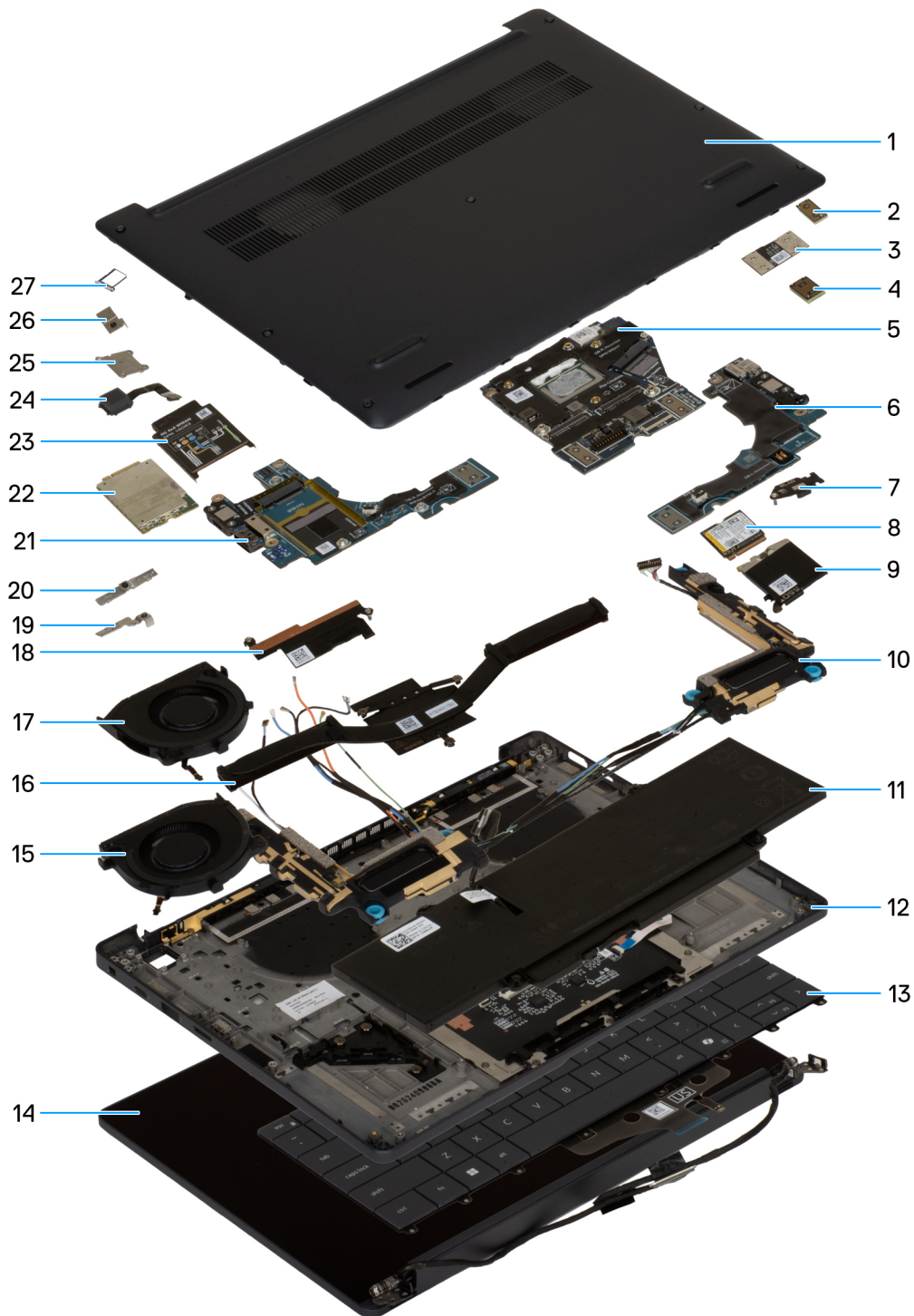



Figure 9. Major Components of your system/exploded view

1. Base cover
2. Interposer board
3. I/O-board FPC
4. Interposer board
5. System board
6. Right I/O-board
7. WWAN-card bracket

8. Solid state drive (SSD)
9. Solid state drive (SSD) shield
10. Speakers
11. Battery
12. Palm-rest assembly
13. Keyboard
14. Display assembly
15. Right fan
16. Heat sink
17. Left fan
18. EDP-cable bracket
19. Darwin antenna-cable bracket
20. WWAN-card bracket
21. Left I/O-board
22. WWAN card
23. WWAN-card shield
24. Fingerprint-reader cable
25. Power-button bracket
26. Power button
27. nano-SIM card tray

 **NOTE:** Dell provides a list of components and their part numbers for the original computer configuration purchased. These parts are available according to warranty coverage purchased by the customer. Contact your Dell sales representative for purchase options.

Removing and installing Customer Replaceable Units (CRUs)

The replaceable components in this chapter are Customer Replaceable Units (CRUs).

 **CAUTION:** Customers can replace only the Customer Replaceable Units (CRUs) following the safety precautions and replacement procedures.

 **NOTE:** The images in this document may differ from your computer depending on the configuration you ordered.

nano-SIM card tray

Removing the nano-SIM card tray

Prerequisites

1. Follow the procedure in [Before working inside your computer](#).

 **NOTE:** Ensure that your computer is in Service Mode. For more information, see [Before working inside your computer](#).

About this task

 **NOTE:** This procedure applies only to computers shipped with a nano-SIM card tray installed. No pre-removals for models shipped without WWAN antennas.

The following images indicate the location of the nano-SIM card tray and provide a visual representation of the removal procedure.

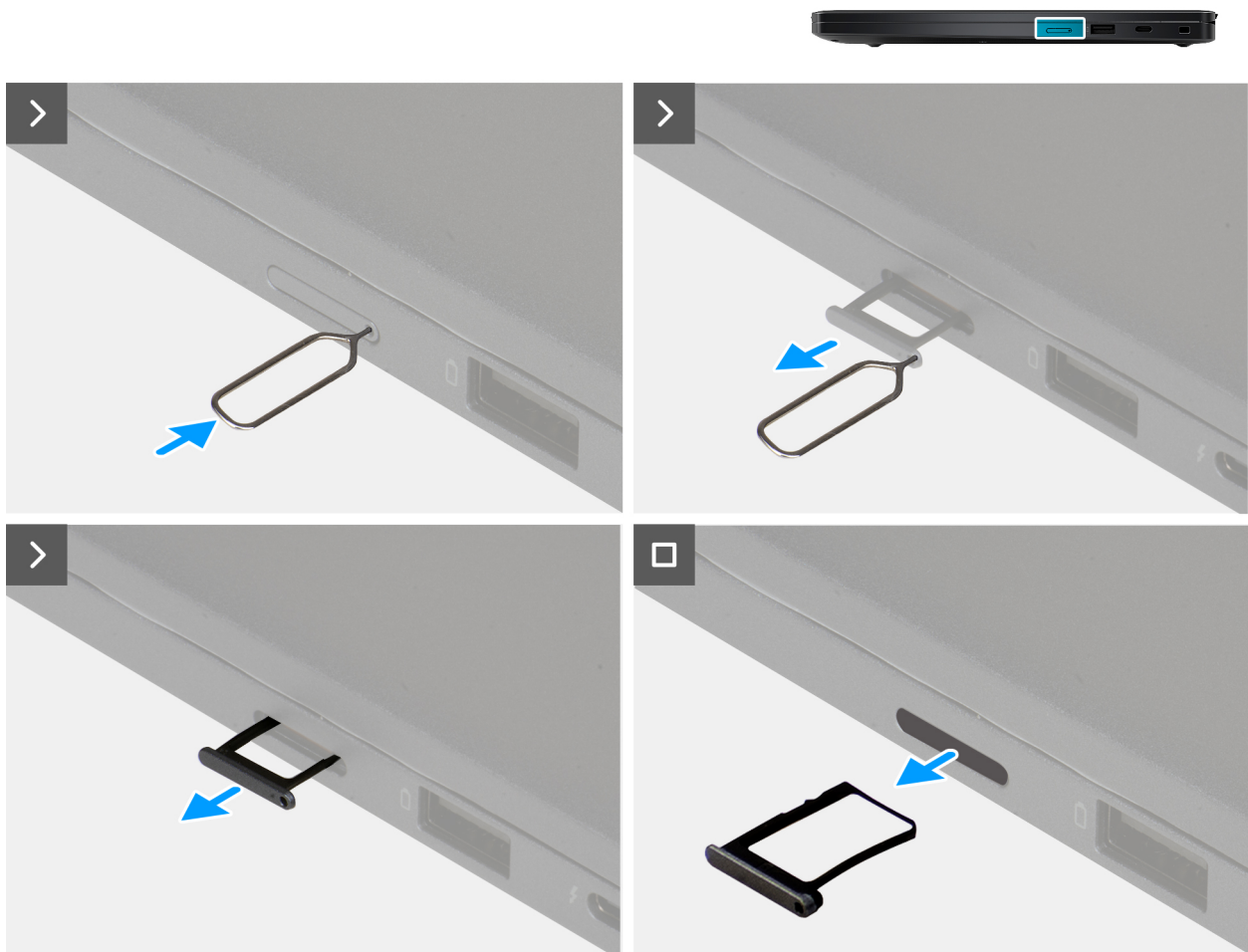

Figure 10. Removing the nano-SIM card tray

Steps

1. Insert a pin into the release hole of the nano-SIM card tray and push inward until the tray is released.
2. Push the SIM-ejector pin to disengage the lock, and eject the nano-SIM card tray.
3. Slide the nano-SIM card tray out of the slot on the computer.

Installing the nano-SIM card tray

Prerequisites

If you are replacing a component, remove the existing component before performing the installation procedure.

About this task

The following images indicate the location of the nano-SIM card tray and provide a visual representation of the installation procedure.

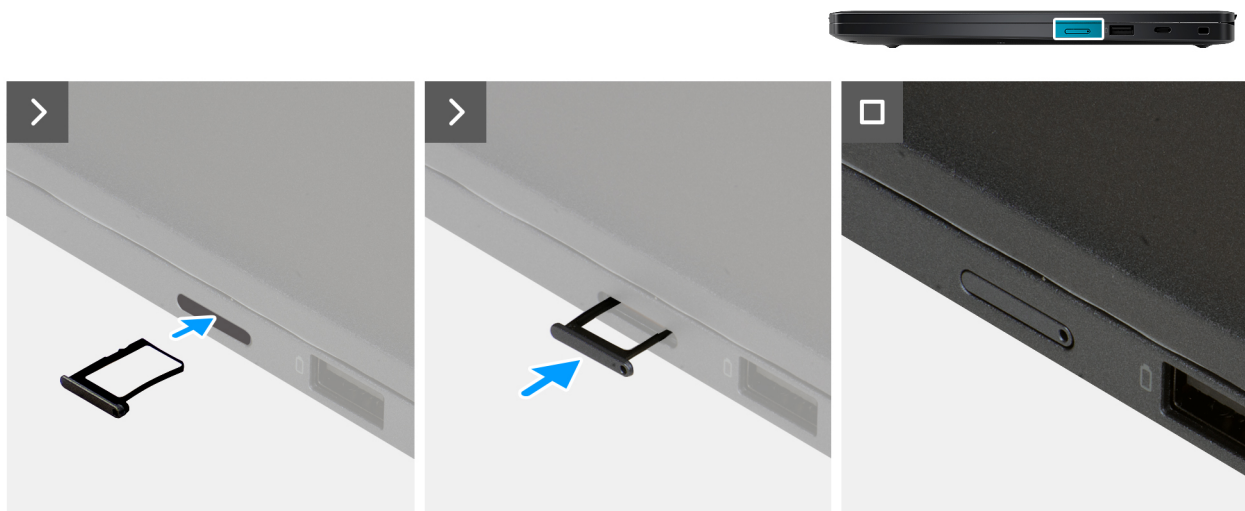

Figure 11. Installing the nano-SIM card tray

Steps

Align the nano-SIM card tray with the slot on the computer and carefully slide it in.

Next steps

1. Follow the procedure in [After working inside your computer](#).

nano-SIM card

Removing the nano-SIM card

Prerequisites

1. Follow the procedure in [Before working inside your computer](#).

NOTE: Ensure that your computer is in Service Mode. For more information, see [Before working inside your computer](#).

2. Remove the [nano-SIM card tray](#).

CAUTION: Removing the nano-SIM card when the computer is turned on can cause data loss or damage the card. Ensure that your computer is turned off or the network connections are disabled.

About this task

The following images indicate the location of the nano-SIM card and provide a visual representation of the removal procedure.

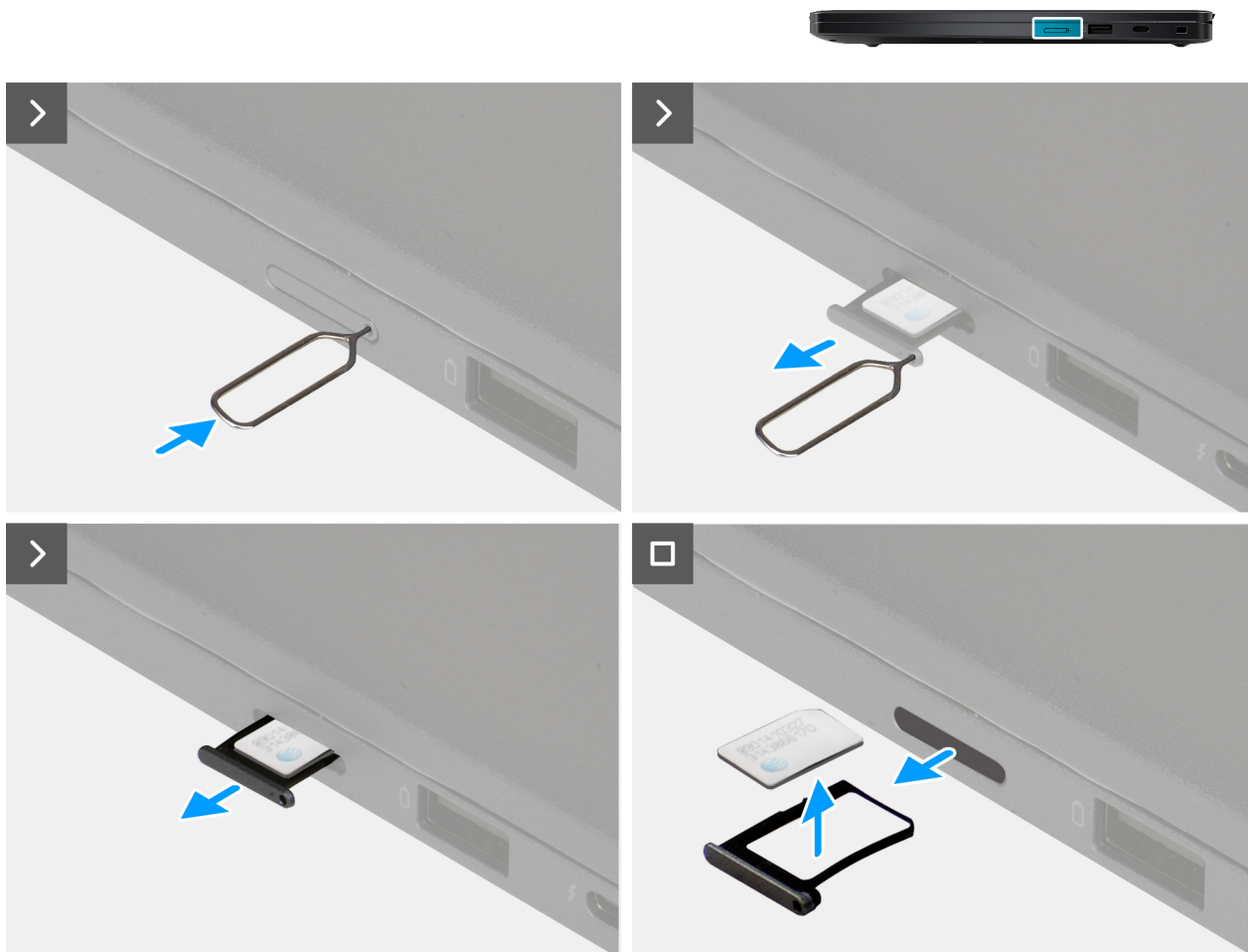

Figure 12. Removing the nano-SIM card

Steps

1. Insert a SIM-ejector pin into the release hole to release the nano-SIM card tray.
2. Push the SIM-ejector pin to disengage the lock, and eject the nano-SIM card tray.
3. Slide the nano-SIM card tray out of the slot on the computer.
4. Remove the nano-SIM card from the nano-SIM card tray.

Installing the nano-SIM card

Prerequisites

If you are replacing a component, remove the existing component before performing the installation procedure.

About this task

The following images indicate the location of the nano-SIM card and provide a visual representation of the installation procedure.

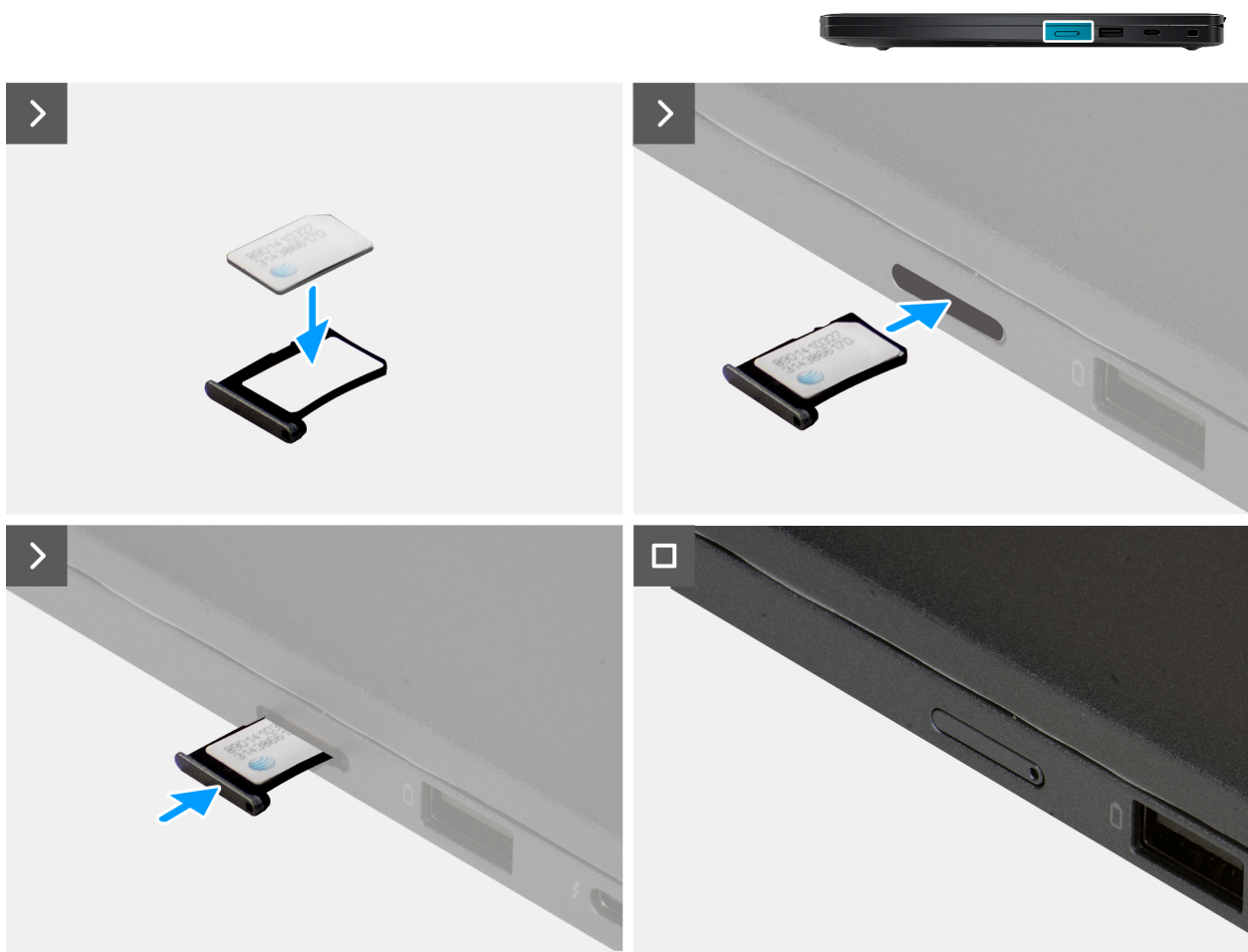

Figure 13. Installing the nano-SIM card

Steps

1. Align and place the nano-SIM card into the nano-SIM card tray with the metallic contact facing up.
2. Align the nano-SIM card tray with the slot on the computer and carefully slide it in.

Next steps

1. Install the [nano-SIM card tray](#).
2. Follow the procedure in [After working inside your computer](#).

Base cover

Removing the base cover

Prerequisites

1. Follow the procedure in [Before working inside your computer](#).

NOTE: Ensure that your computer is in Service Mode. For more information, see [Before working inside your computer](#).

About this task

The following images indicate the location of the base cover and provide a visual representation of the removal procedure.

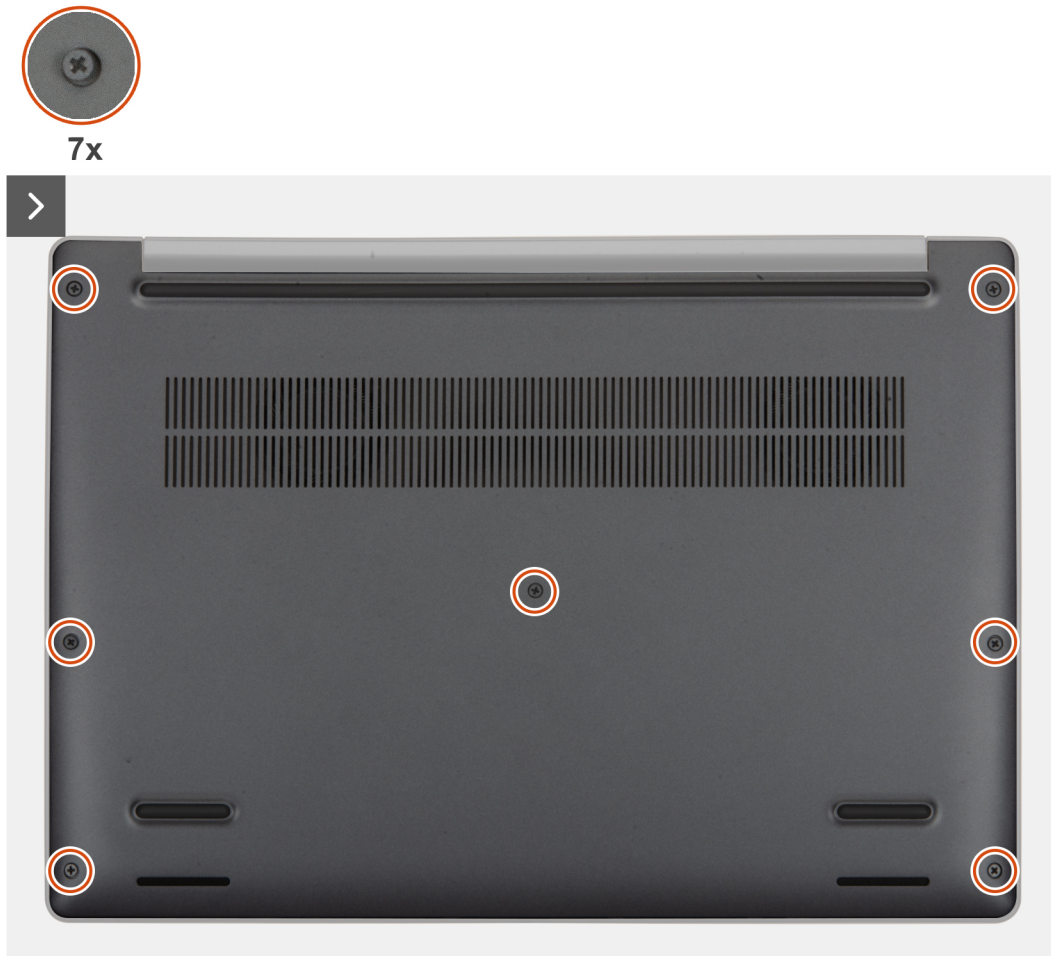

Figure 14. Loosen the captive screws

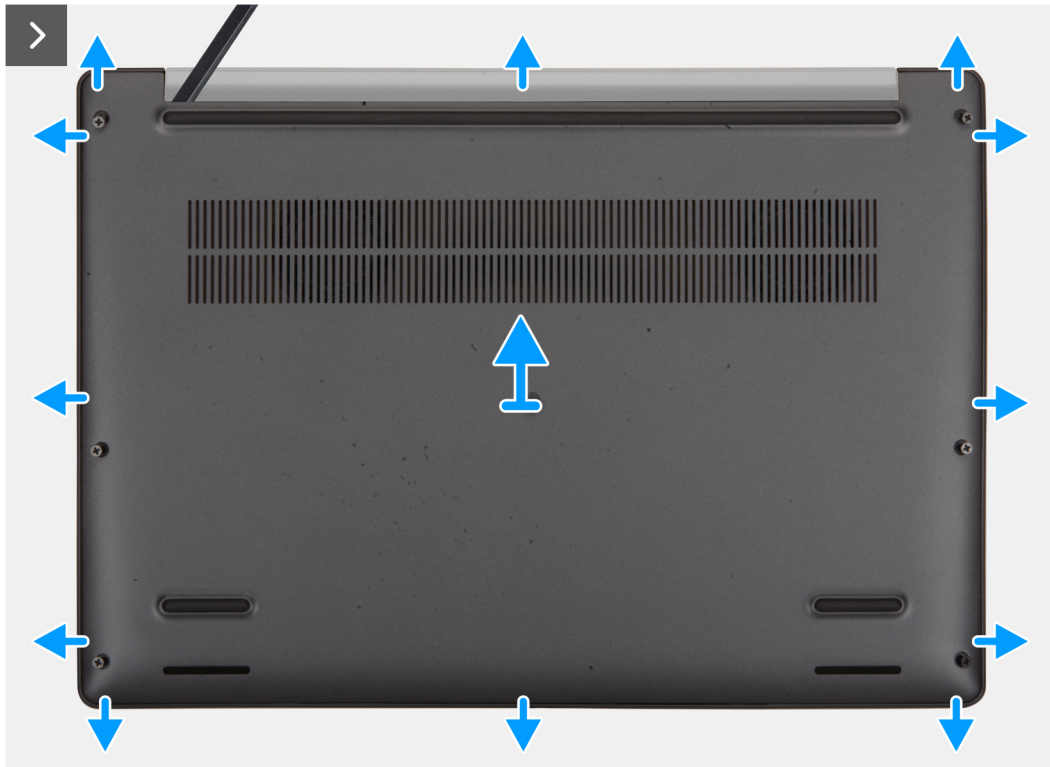

Figure 15. Removing the base cover

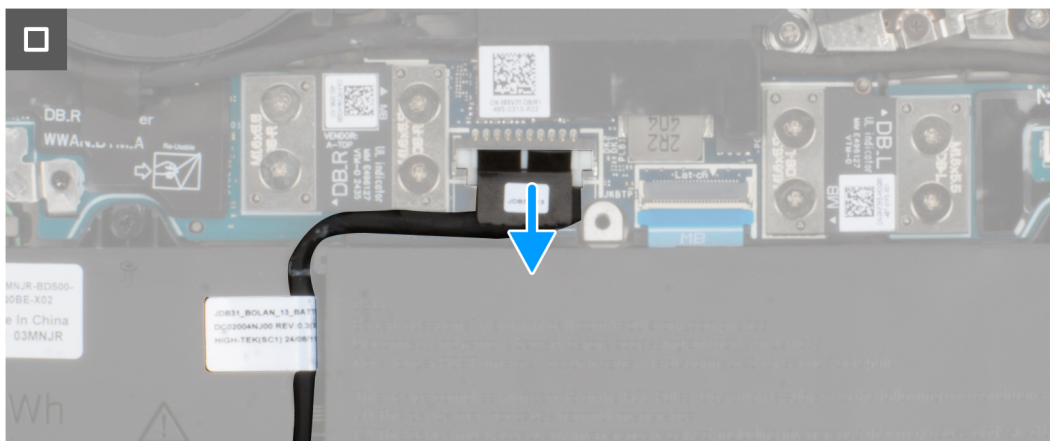

Figure 16. Disconnect the battery cable from the system board

Steps

1. Loosen the seven captive screws that secure the base cover to the palm-rest and keyboard assembly.
2. Using a plastic scribe, pry open the base cover starting from the recesses, which are located in the U-shaped indents at the top edge of the base cover, near the hinges.
 - ⚠ **CAUTION:** Do not slide the scribe through the edge of the top side of the base cover as it damages the latches inside the base cover.
 - ⚠ **CAUTION:** Do not pry upwards from the edge near the vents, at the top side of the base cover, as it damages the base cover.
3. Pry open the top side of the base cover and continue working on the left, right and, bottom sides to open the base cover.
4. Lift the base cover from the left and right sides and remove the base cover off the palm-rest and keyboard assembly.
5. Disconnect the battery cable from the system board.

Installing the base cover

Prerequisites

If you are replacing a component, remove the existing component before performing the installation procedure.

About this task

The following images indicate the location of the base cover and provide a visual representation of the installation procedure.

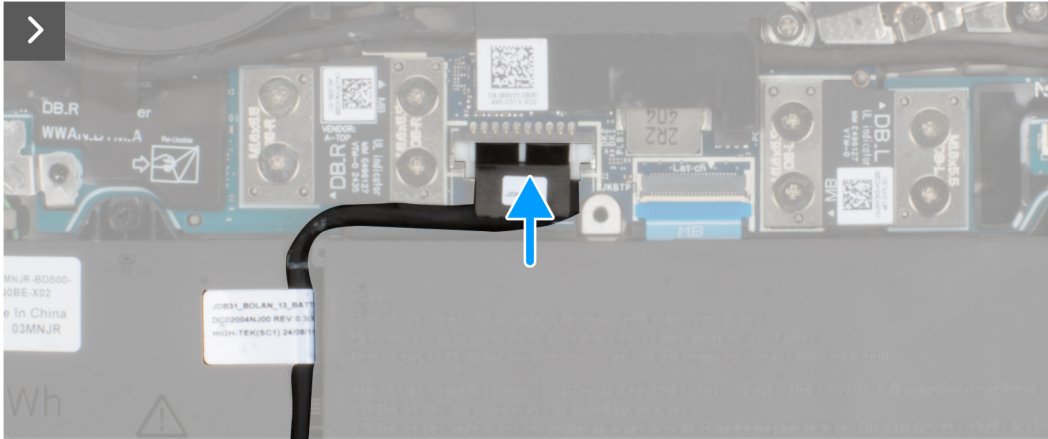

Figure 17. Connect the battery battery cable to the system board

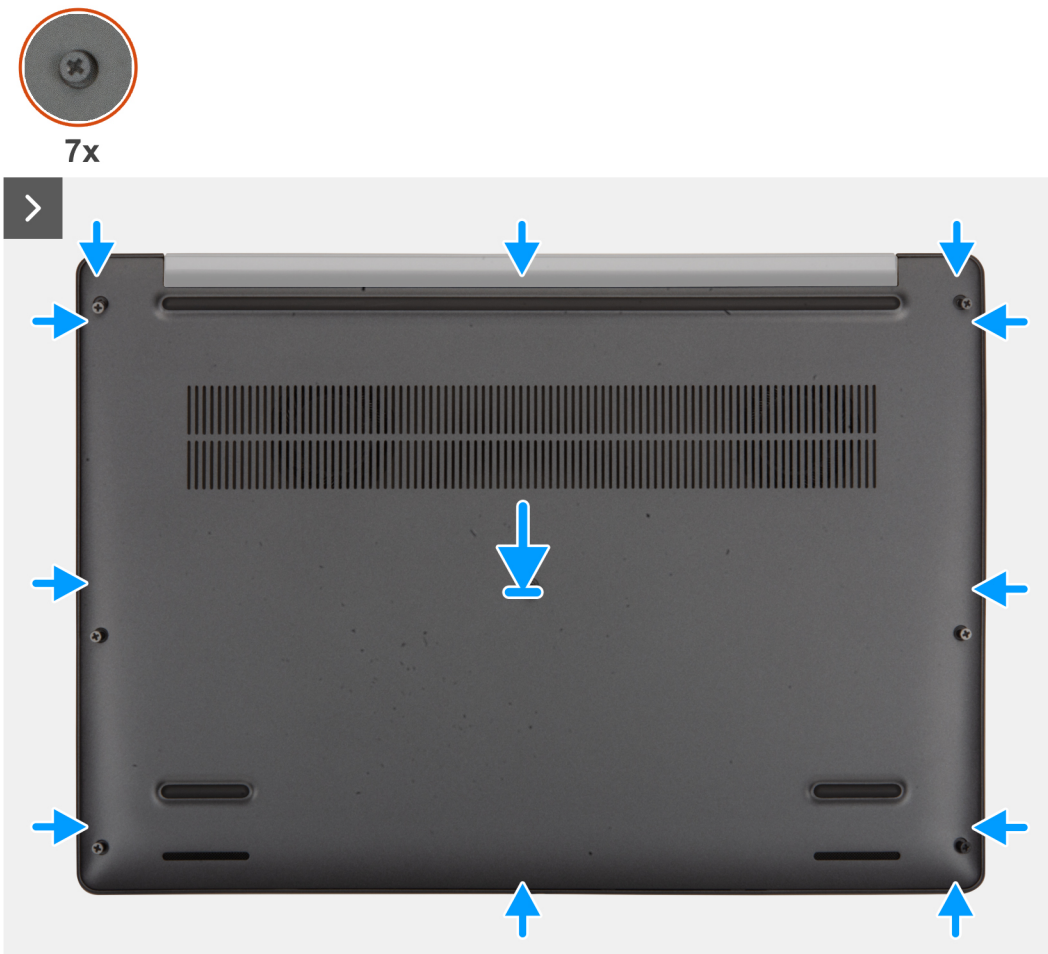

Figure 18. Installing the base cover



Figure 19. Tighten the captive screws

Steps

1. Connect the battery cable to the battery-cable connector on the system board.
2. Place the base cover on top of the palm-rest and keyboard assembly.
3. Align the screw holes on the base cover with the screw holes on the palm-rest and keyboard assembly, and snap the base cover into place.
4. Tighten the seven captive screws to secure the base cover to the palm-rest and keyboard assembly.

Next steps

1. Follow the procedure in [After working inside your computer](#).

Battery

Rechargeable Li-ion battery precautions

CAUTION:

- Exercise caution when handling rechargeable Li-ion batteries.
- Discharge the battery completely before removing it. Disconnect the AC power adapter from the computer and operate the computer solely on battery power—the battery is fully discharged when the computer no longer turns on when the power button is pressed.
- Do not crush, drop, mutilate, or penetrate the battery with foreign objects.
- Do not expose the battery to high temperatures, or disassemble battery packs and cells.
- Do not apply pressure to the surface of the battery.
- Do not bend the battery.
- Do not use tools of any kind to pry on or against the battery.
- To prevent accidental puncture or damage to the battery and other components, ensure that no screws are lost or misplaced during the servicing of this product.

- If the battery gets stuck inside your computer as a result of swelling, do not try to release it as puncturing, bending, or crushing a rechargeable Li-ion battery can be dangerous. In such an instance, contact Dell technical support for assistance. See [Contact Support at Dell Support Site](#).
- Always purchase genuine batteries from [Dell Site](#) or authorized Dell partners and resellers.
- Swollen batteries should not be used and should be replaced and disposed properly. For guidelines on how to handle and replace swollen rechargeable Li-ion batteries, see [Handling swollen rechargeable Li-ion batteries](#).

Removing the battery

Prerequisites

1. Follow the procedure in [Before working inside your computer](#).
2. Remove the [base cover](#).

About this task

CAUTION: Removing the battery resets the BIOS setup settings to default. It is recommended that you note the BIOS setup settings before removing the battery.

The following images indicate the location of the battery and provide a visual representation of the removal procedure.

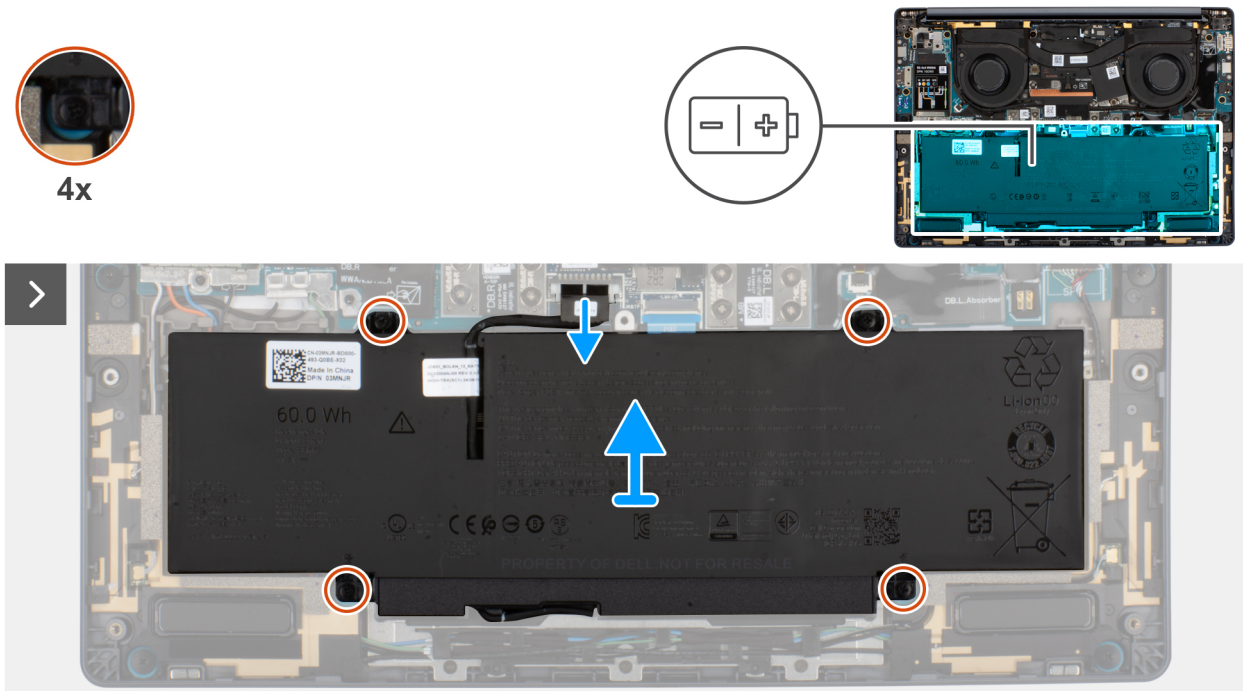

Figure 20. Loosen the captive screws

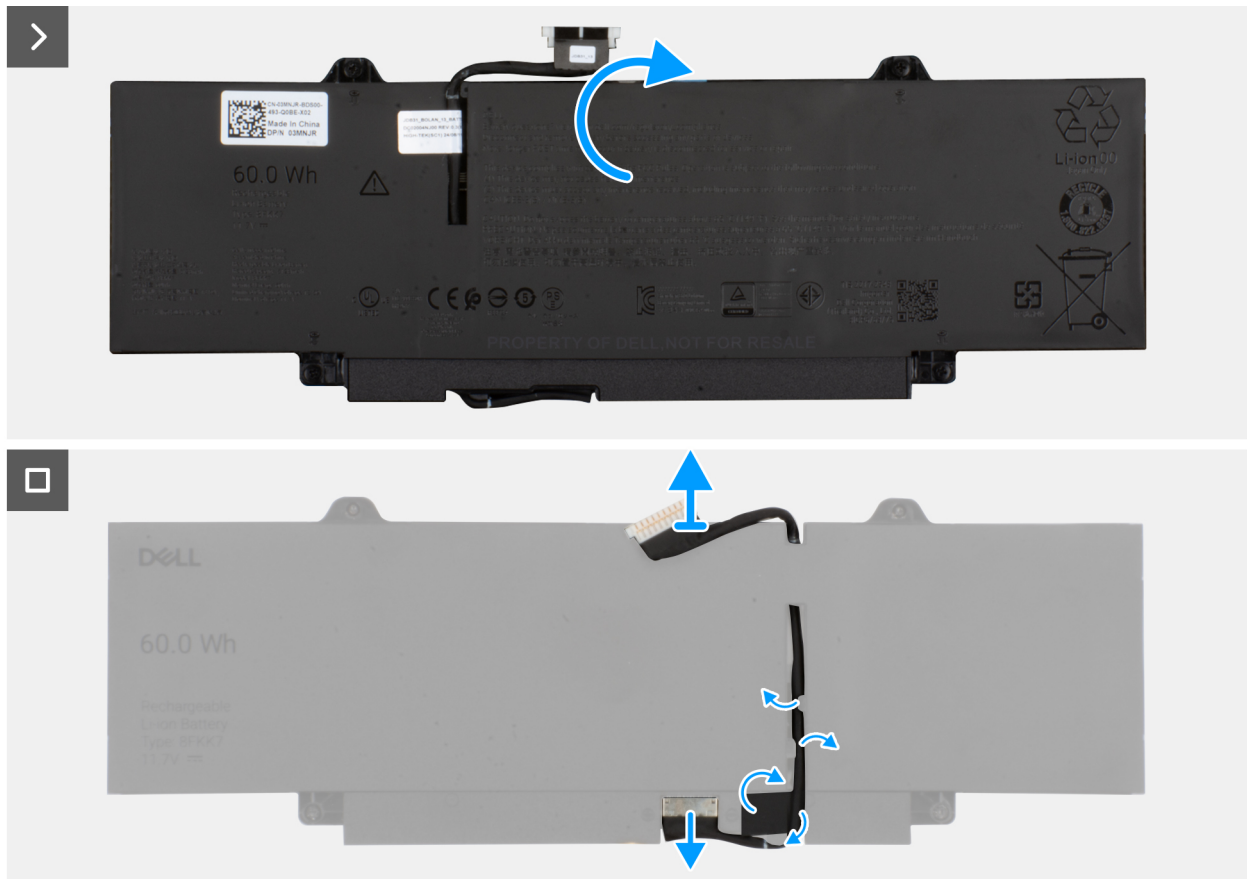

Figure 21. Removing the battery and disconnecting the battery cable

Steps

1. Disconnect the battery cable from the battery-cable connector on the system board (if not disconnected earlier).
2. Loosen the four captive screws that secure the battery to the palm-rest assembly.
3. Lift the battery off the palm-rest assembly.
4. Flip the battery and peel the tape that adheres the battery cable to the battery.
5. Remove the battery cable from the routing guides on the battery.
6. Disconnect the battery cable from the connector on the battery.
7. Remove the battery cable away from the battery.

Installing the battery

Prerequisites

If you are replacing a component, remove the existing component before performing the installation procedure.

About this task

The following images indicate the location of the battery and provide a visual representation of the installation procedure.

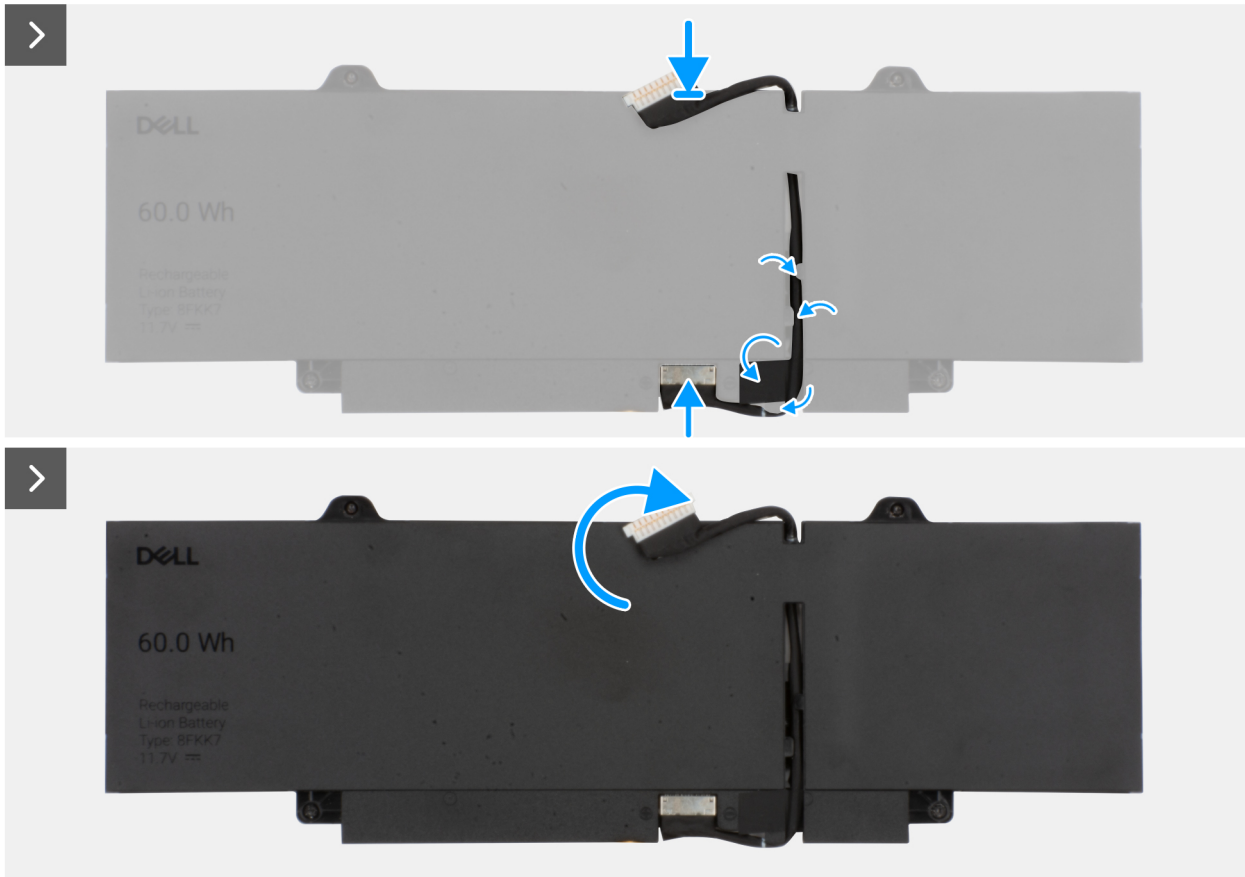
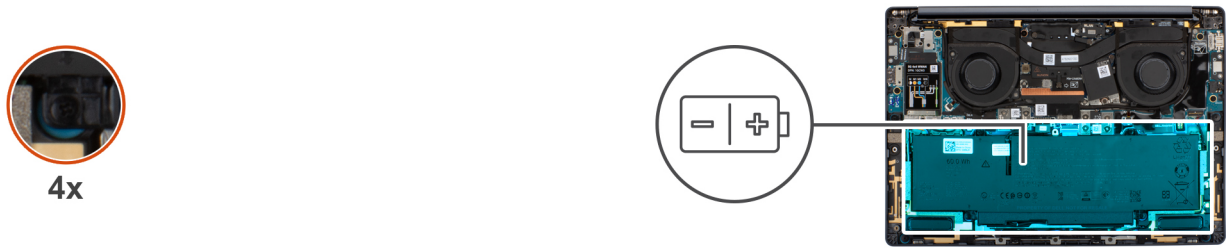

Figure 22. Connecting the battery cable

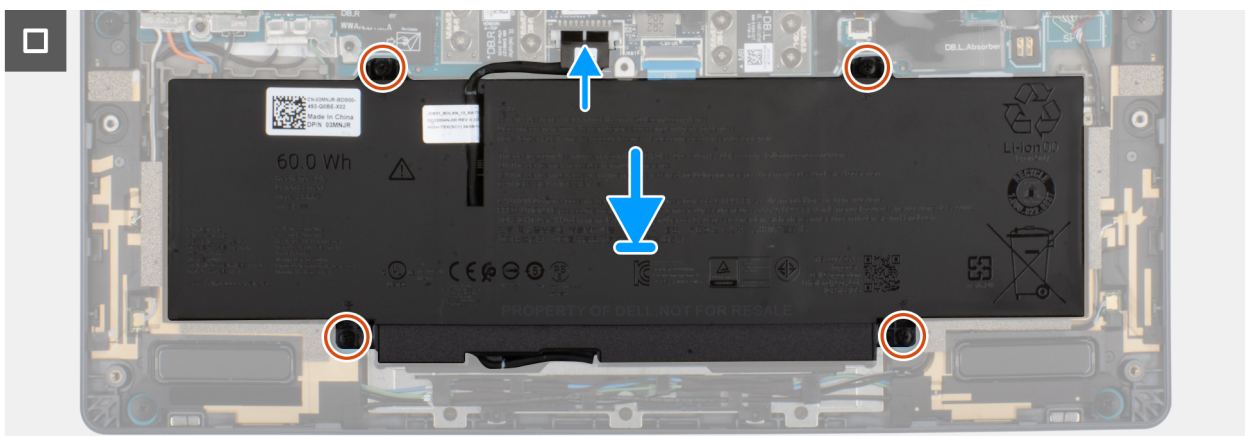

Figure 23. Installing the battery

Steps

1. Align and route the battery cable through the routing guides on the battery.

2. Adhere the tape that secures the battery cable to the battery.
3. Connect the battery cable to the connector on the battery.
4. Flip the battery.
5. Using the alignment posts, place the battery on the palm-rest assembly.
6. Align the screw holes on the battery with the screw holes on the palm-rest assembly.
7. Tighten the four captive screws that secure the battery to the palm-rest assembly.
8. Connect the battery cable to the battery-cable connector on the system board.

Next steps

1. Install the [base cover](#).
2. Follow the procedure in [After working inside your computer](#).

Solid state drive (SSD)

Removing the M.2 2230 solid state drive

Prerequisites

1. Follow the procedure in [Before working inside your computer](#).

NOTE: Solid state drives are fragile. Exercise care when handling the solid state drive.

NOTE: To avoid data loss, do not remove the solid state drive while the computer is in sleep or on state.

2. Remove the [base cover](#).

About this task

The following image indicates the location of the M.2 2230 SSD and provides a visual representation of the removal procedure.

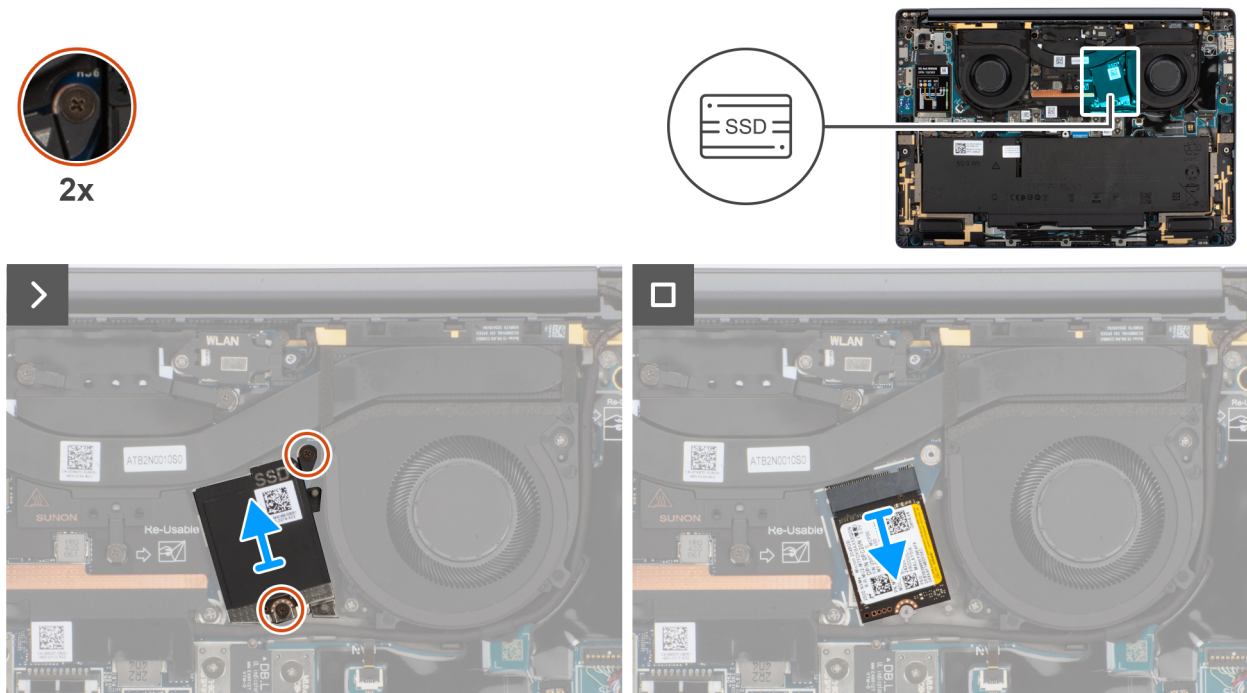

Figure 24. Removing the SSD

Steps

1. Loosen the two captive screws that secure the SSD shield cover from the system board.
2. Remove the SSD shield cover from the computer.
3. Slide and remove the SSD from the SSD slot on the system board.

Installing the M.2 2230 solid state drive

Prerequisites

If you are replacing a component, remove the existing component before performing the installation procedure.

About this task

The following image indicates the location of the M.2 2230 solid state drive (SSD) and provides a visual representation of the installation procedure.

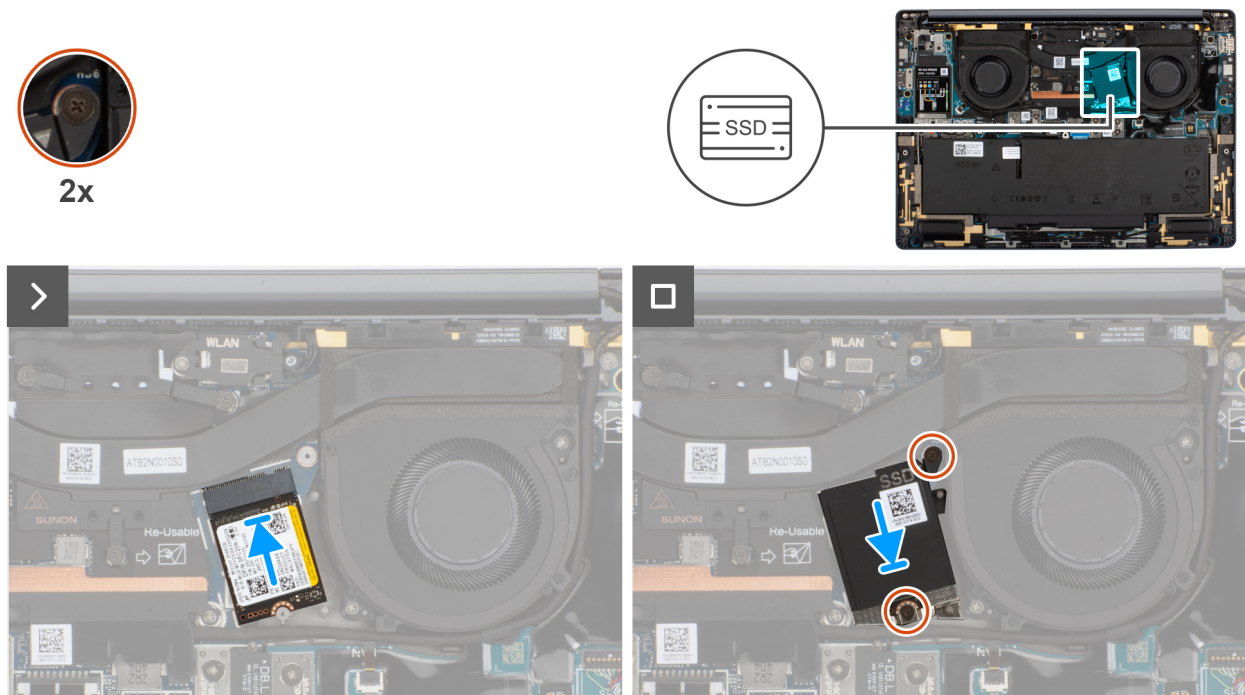

Figure 25. Installing the SSD

Steps

1. Align the notch on the SSD with the tab on the SSD slot on the system board.
2. Replace the two captive screws to secure the SSD shield cover to the system board.

Next steps

1. Install the [base cover](#).
2. Follow the procedure in [After working inside your computer](#).
3. Verify if the storage device is installed correctly:
 - a. Turn on or restart your system.
 - b. Press F2 when the Dell logo is displayed on the screen to enter the system setup (BIOS) program.

NOTE: A list of storage devices are displayed under the **System Information** in the **General** group.

- c. If you have replaced the primary storage device that had the operating system that is installed, search in the Knowledge Base Resource at [Dell Support Site](#).

Wireless Wide Area Network (WWAN) card

Removing the WWAN card

Prerequisites

1. Follow the procedure in [Before working inside your computer](#).
2. Remove the [nano-SIM card tray](#).
3. Remove the [nano-SIM card](#).
4. Remove the [base cover](#).

About this task

NOTE: This procedure applies only to computers shipped with a WWAN card installed.

NOTE: When reinstalling the WWAN card shield cover, ensure that the shielding cover is inserted into the clips on the right I/O-board.

The following images indicate the location of the WWAN card and provide a visual representation of the removal procedure.

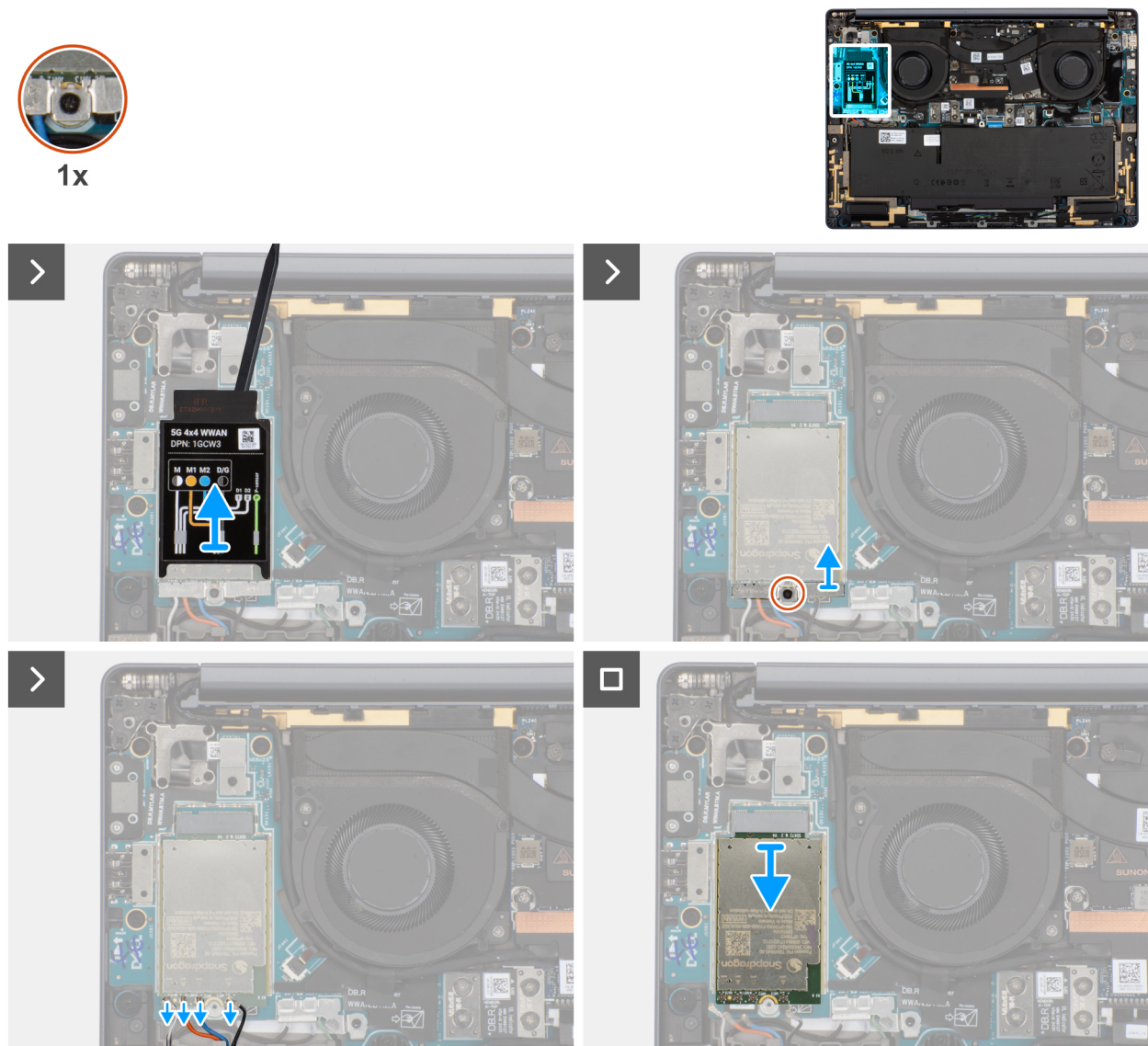

Figure 26. Removing the WWAN card

Steps

1. Pry the WWAN shield cover from the top-left side of the shielding cover and remove it from the computer.
2. Lift the WWAN shield cover off the right I/O-board.
3. Loosen the single captive screw that secures the WWAN-card bracket to the right I/O-board.
4. Remove the WWAN-card bracket from the computer.
5. Disconnect the antenna cables from the connectors on the WWAN card.
6. Slide and remove the WWAN card from the WWAN card slot on the right I/O-board.

Installing the WWAN card

Prerequisites

If you are replacing a component, remove the existing component before performing the installation procedure.

 **NOTE:** When reinstalling the WWAN card shielding cover, ensure that the shielding cover is inserted into the clips on the right I/O-.

About this task

The following images indicate the location of the WWAN card and provide a visual representation of the installation procedure.



1x

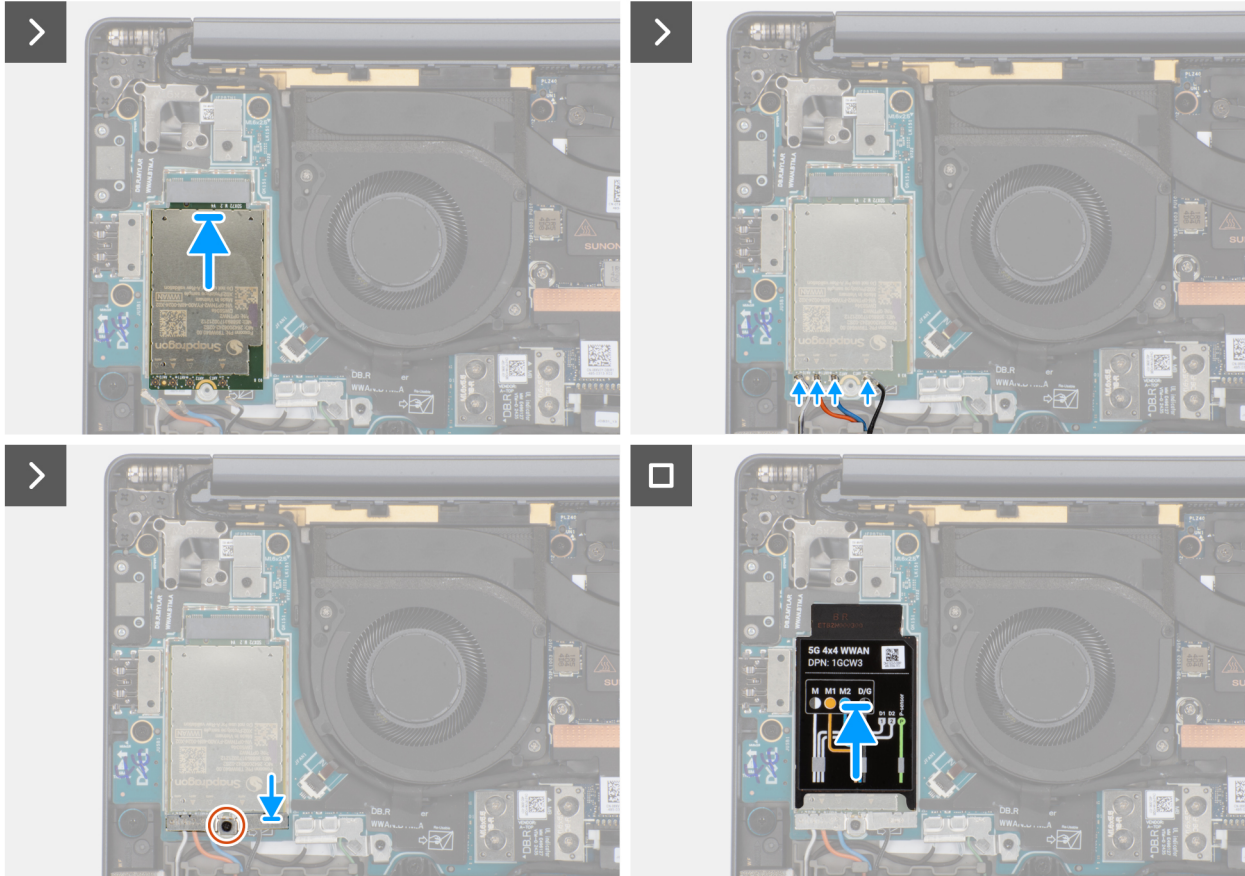

Figure 27. Installing the WWAN card

Steps

1. Align the notch on the WWAN card with the tab on the WWAN card slot on the system board.
2. Slide the WWAN card firmly into the WWAN card slot on the system board.
3. Connect the antenna cables to the connectors on the WWAN card.

The following table provides the antenna-cable color scheme for the WWAN card that is supported on your computer.

Table 31. Antenna-cable color scheme for WWAN cards

Connectors on the WWAN card	Antenna-cable color	Silkscreen marking	
D/G	Black with a thin white stripe	ANT3 D/G	△ (white triangle)
M2	Blue	ANT2 M2	△ (white triangle)
M1	Orange	ANT1 M1	△ (white triangle)
M	White with a thin gray stripe	ANT0 M	△ (white triangle)

4. Place the WWAN-card bracket on the WWAN card.

5. Align the screw on the WWAN-card bracket with the screw hole on the system board.
6. Replace the captive screw that secures the WWAN-card bracket to the system board.
7. Place the WWAN shielding cover over the WWAN card and secure it in place.

i NOTE: For instructions on how to find your computer's International Mobile Station Equipment Identity (IMEI) number, search in the Knowledge Base Resource at [Dell Support Site](#).

Next steps

1. Install the [base cover](#).
2. Install the [nano-SIM card](#).
3. Install the [nano-SIM card tray](#).
4. Follow the procedure in [After working inside your computer](#).

Fan

Removing the left fan

Prerequisites

1. Follow the procedure in [Before working inside your computer](#).
2. Remove the [base cover](#).

About this task

The following image indicates the location of the left fan and provides a visual representation of the removal procedure.

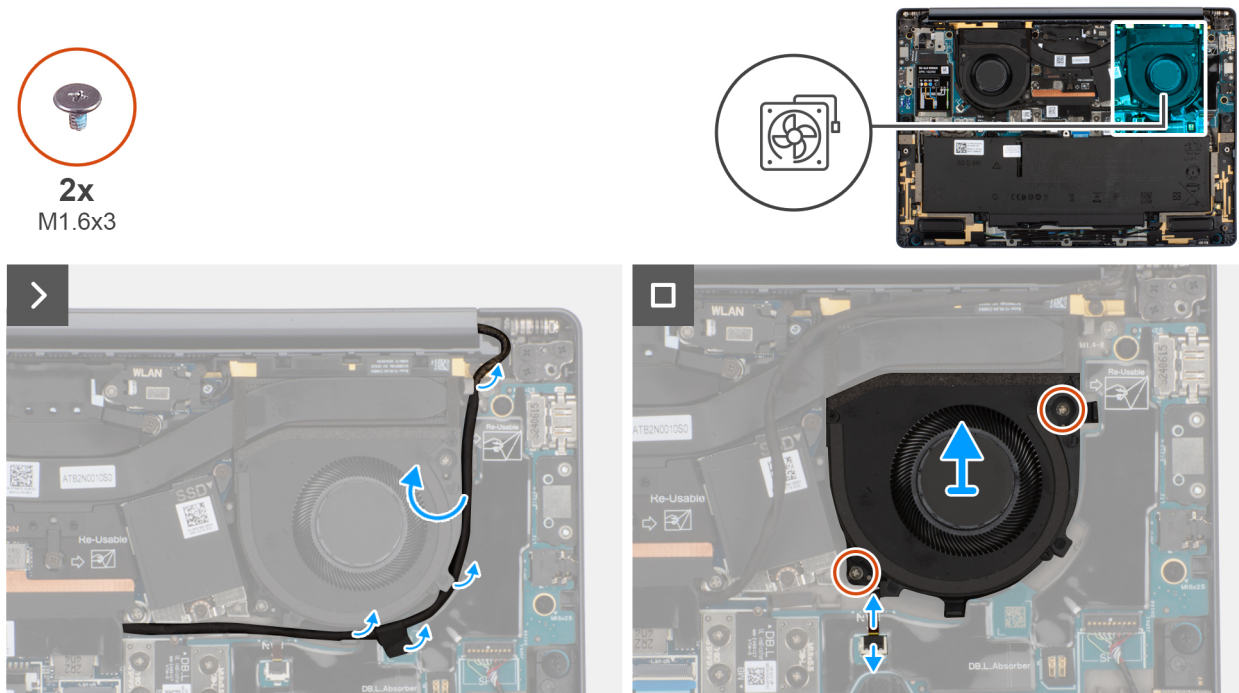

Figure 28. Removing the left fan

Steps

1. Unroute the camera cable from the routing channels along the sides of the left fan.
2. Disconnect the left-fan cable from the connector on the left I/O-board.
3. Remove the two screws (M1.6x3) that secure the left fan.
4. Remove the left fan from the palm-rest assembly.

Installing the left fan

Prerequisites

If you are replacing a component, remove the existing component before performing the installation procedure.

About this task

The following image indicates the location of the left fan and provides a visual representation of the installation procedure.

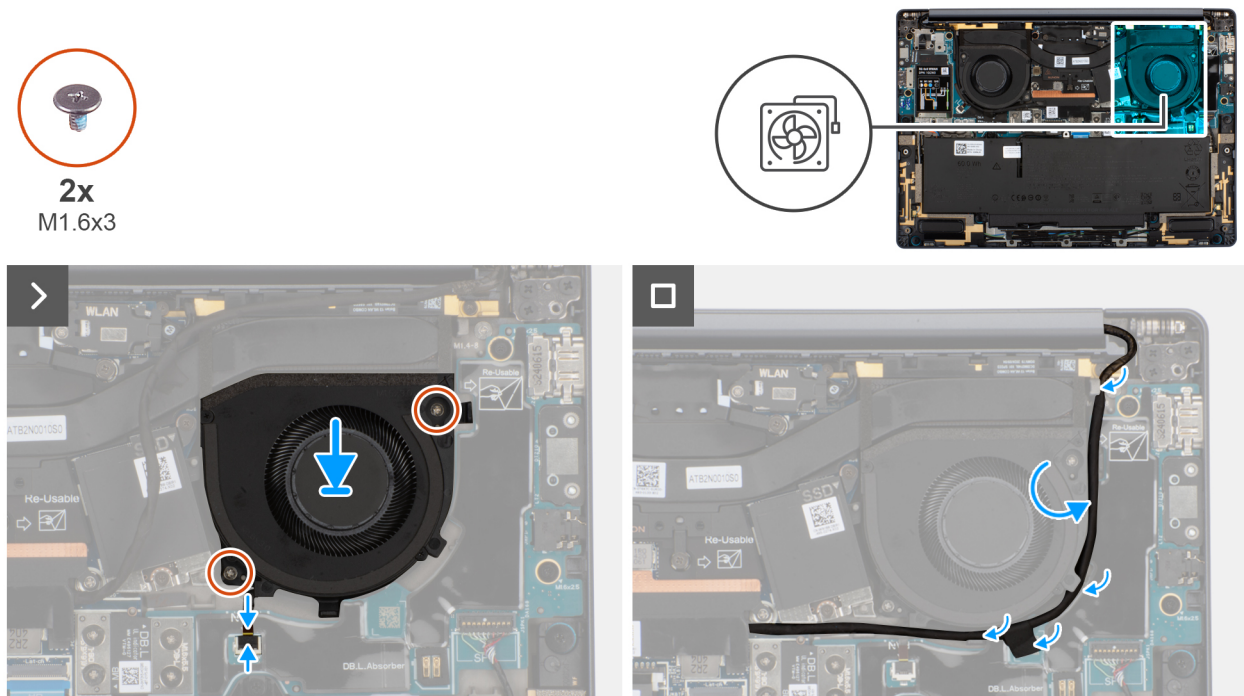

Figure 29. Installing the left fan

Steps

1. Place the left fan on the palm-rest assembly.
2. Align the screw holes on the left fan to the screw holes on the palm-rest assembly.
3. Replace the two screws (M1.6x3) that secure the left fan to the palm-rest assembly.
4. Connect the left fan cable to the connector on the left I/O-board.

Next steps

1. Install the [base cover](#).
2. Follow the procedure in [After working inside your computer](#).

Removing the right fan

Prerequisites

1. Follow the procedure in [Before working inside your computer](#).
2. Remove the [base cover](#).

About this task

The following image indicates the location of the right fan and provides a visual representation of the removal procedure.



2x
M1.6x3

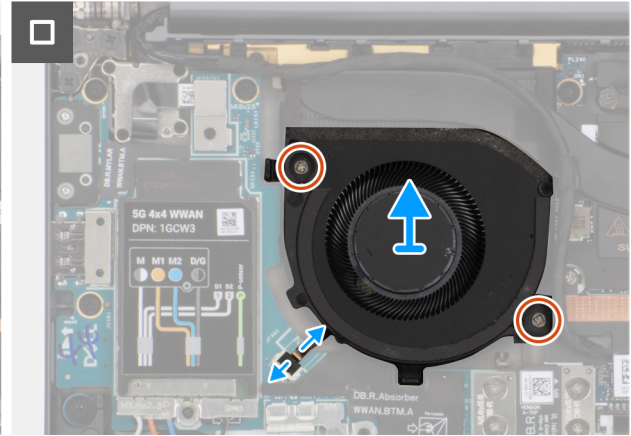
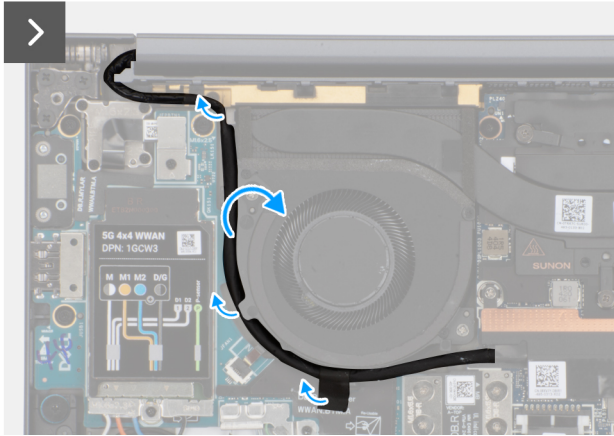
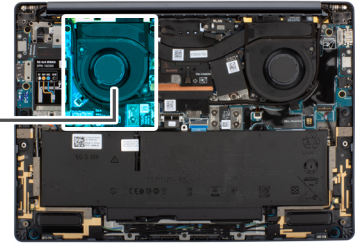
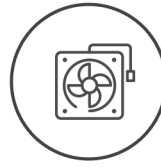

Figure 30. Removing the right fan

Steps

1. Unroute the camera cable from the routing channels along the sides of the right fan.
2. Disconnect the right-fan cable from the connector on the right I/O-board.
3. Remove the two screws (M1.6x3) that secure the right fan.
4. Remove the right fan from the palm-rest assembly.

Installing the right fan

Prerequisites

If you are replacing a component, remove the existing component before performing the installation procedure.

About this task

The following image indicates the location of the right fan and provides a visual representation of the installation procedure.

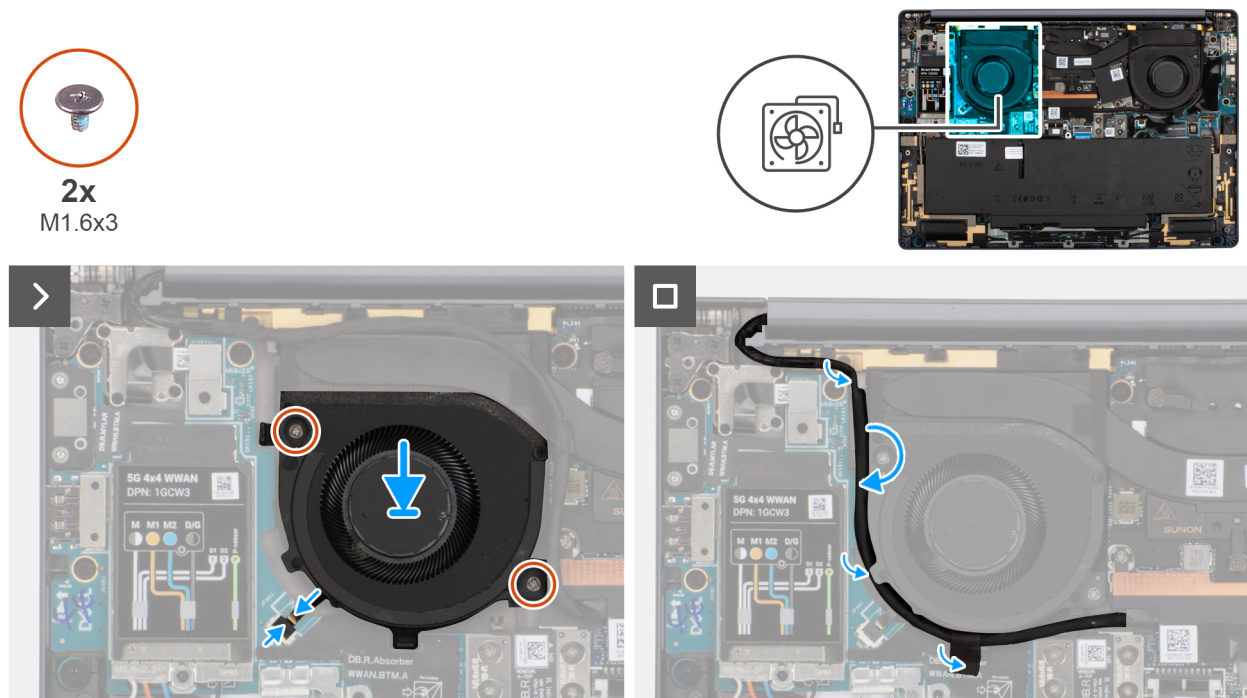

Figure 31. Installing the right fan

Steps

1. Place the right fan on the palm-rest assembly.
2. Align the screw holes on the right fan to the screw holes on the palm-rest assembly.
3. Replace the two screws (M1.6x3) that secure the right fan to the palm-rest assembly.
4. Connect the right-fan cable to the connector on the right I/O-board.

Next steps

1. Install the [base cover](#).
2. Follow the procedure in [After working inside your computer](#).

Speakers

Removing the speakers without antenna (WLAN configuration)

Prerequisites

1. Follow the procedure in [Before working inside your computer](#).
2. Remove the [base cover](#).

About this task

The following image indicates the location of the speakers and provides a visual representation of the removal procedure.



4x
M2x2

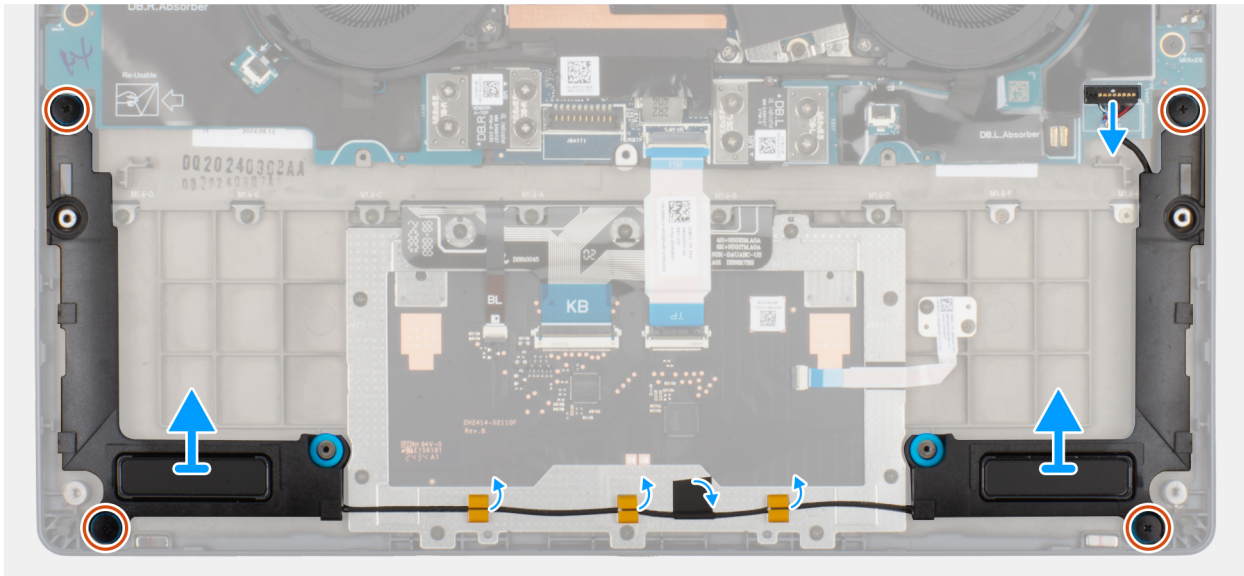
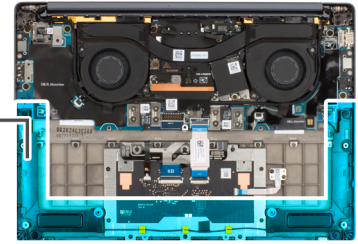
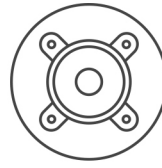

Figure 32. Removing the speakers without antenna (WLAN configuration)

Steps

1. Disconnect the speaker cable from the connector on the left I/O-board.
2. Remove the four screws (M2x2) that secure the speakers in place.
3. Peel the tape that secures the speaker cable to the palm-rest and keyboard assembly.
4. Note the speaker cable routing, and unroute the speaker cable from the routing guides on the palm-rest and keyboard assembly.
5. Lift the speakers, along with the cable, off the palm-rest and keyboard assembly.

Installing the speakers without antenna (WLAN configuration)

Prerequisites

If you are replacing a component, remove the existing component before performing the installation procedure.

About this task

The following image indicates the location of the speakers and provides a visual representation of the installation procedure.



4x
M2x2

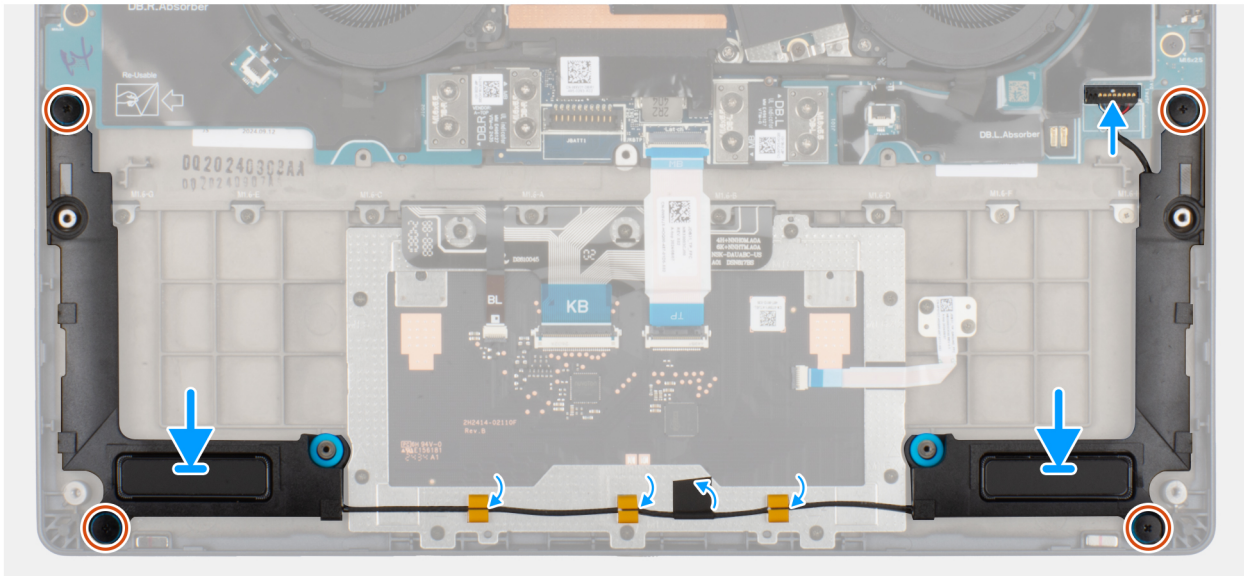
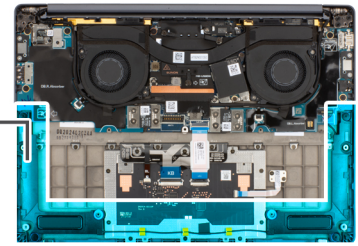
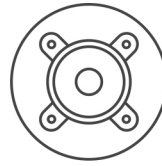

Figure 33. Installing the speakers (without WWAN)

Steps

1. Using the alignment posts and rubber grommets, place the speakers into the slots on the palm-rest and keyboard assembly.
i **NOTE:** To properly position the speakers, secure the rubber grommets into the hooks.
2. Route the speaker cable along the bottom side of the palm-rest and keyboard assembly. Then secure the speaker cable into the routing guides on the palm-rest and keyboard assembly.
3. Replace the four screws (M2x2) that secures the speakers in place.
4. Adhere the tape that secures the speaker cable to the palm-rest and keyboard assembly.
5. Connect the speaker cable to the connector on the left I/O-board.

Next steps

1. Install the [base cover](#).
2. Follow the procedure in [After working inside your computer](#).

Removing and installing Field Replaceable Units (FRUs)

The replaceable components in this chapter are Field Replaceable Units (FRUs).

CAUTION: The information in this section is intended for authorized service technicians only.

CAUTION: To avoid any potential damage to the component or loss of data, ensure that an authorized service technician replaces the Field Replaceable Units (FRUs).

CAUTION: Dell Technologies recommends that this set of repairs, if needed, to be conducted by trained technical repair specialists.

CAUTION: As a reminder, your warranty does not cover damages that may occur during FRU repairs that are not authorized by Dell Technologies.

NOTE: The images in this document may differ from your computer depending on the configuration you ordered.

Speakers

Removing the speakers with antennas (WWAN configuration)

CAUTION: The information in this section is intended for authorized service technicians only.

Prerequisites

1. Follow the procedure in [Before working inside your computer](#).
2. Remove the [nano-SIM card tray](#).
3. Remove the [nano-SIM card](#).
4. Remove the [base cover](#).
5. Remove the [WWAN card](#).

About this task

The following image indicates the location of the speakers and provides a visual representation of the removal procedure.

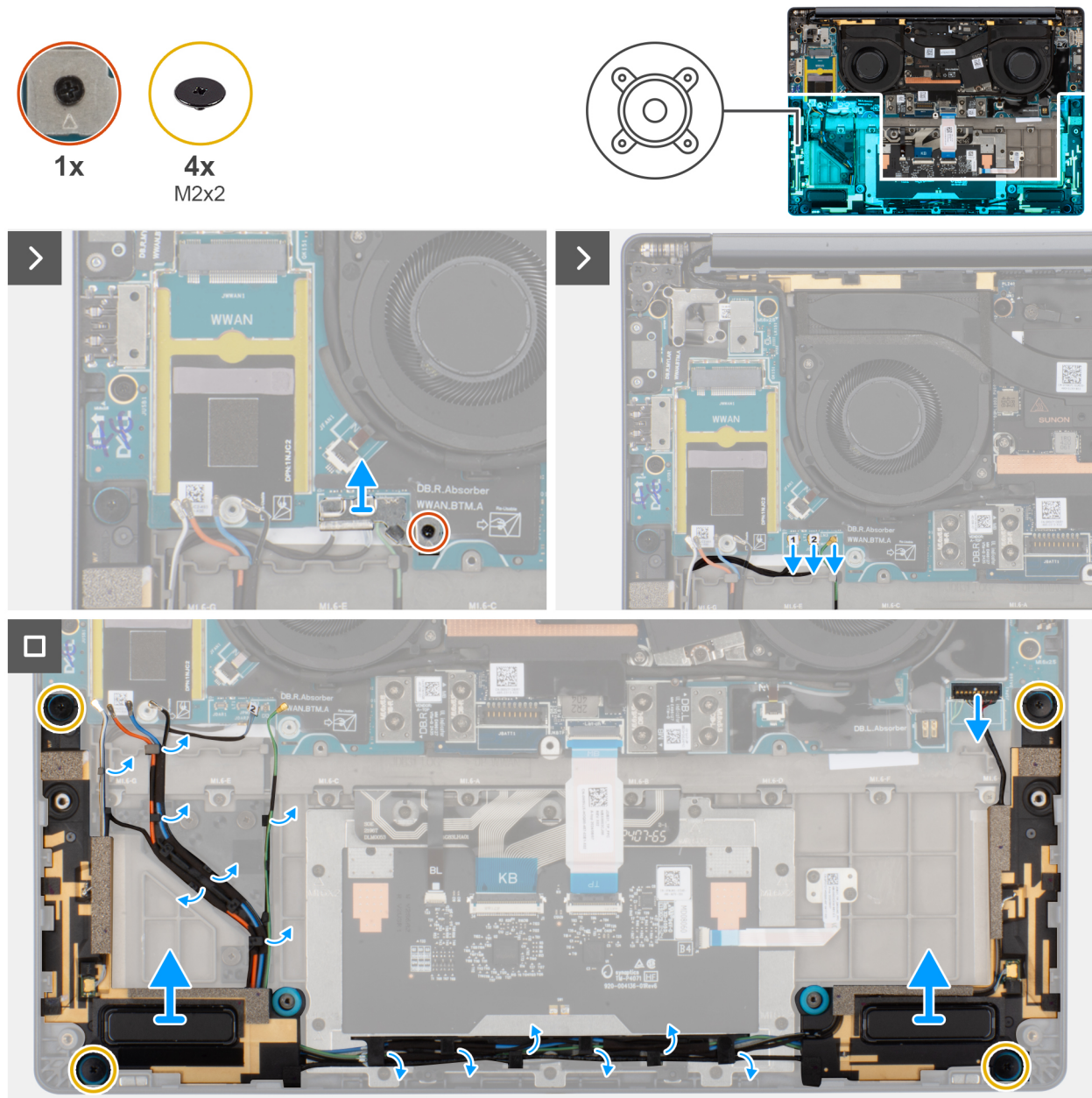

Figure 34. Removing the speakers with antennas (WWAN configuration)

Steps

1. Loosen the captive screw that secures the antenna cables to the WWAN-card bracket.
2. Disconnect and unroute the antenna cables from the routing guide.
3. Disconnect the speaker cable from the connector on the left I/O-board.
4. Remove the four screws (M2x2) that secure the speakers in place.
5. Peel the tape that secures the speaker cable to the palm-rest and keyboard assembly.
6. Note the speaker cable routing, and unroute the speaker cable from the routing guides on the palm-rest and keyboard assembly.
7. Lift the speakers, along with the cable, off the palm-rest and keyboard assembly.

Installing the speakers with antennas (WWAN configuration)

⚠ CAUTION: The information in this section is intended for authorized service technicians only.

Prerequisites

If you are replacing a component, remove the existing component before performing the installation procedure.

About this task

The following image indicates the location of the speakers and provides a visual representation of the installation procedure.

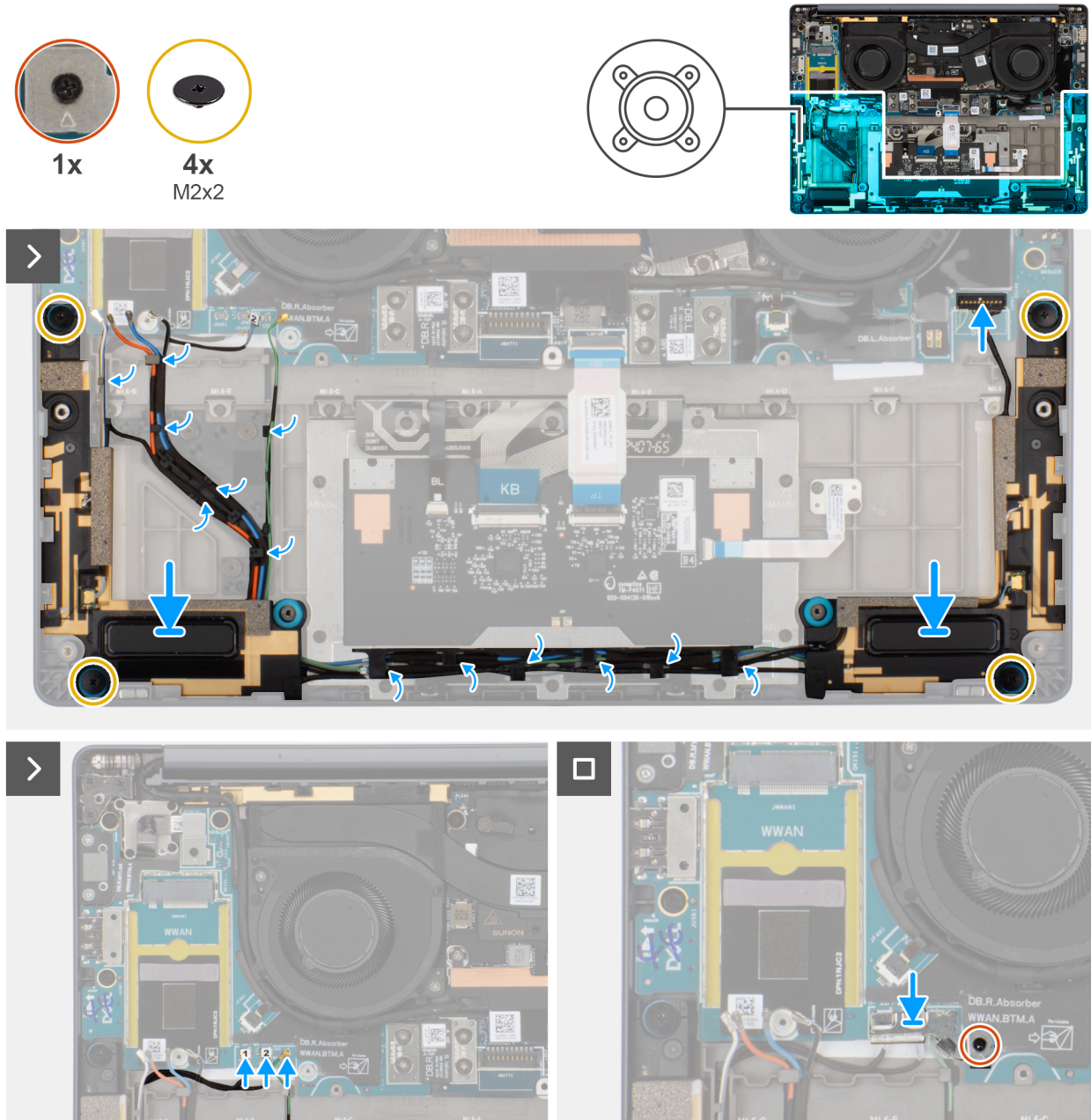

Figure 35. Installing the speakers with antennas (WWAN configuration)

Steps

1. Using the alignment posts and rubber grommets, place the speakers into the slots on the palm-rest and keyboard assembly.
(i) NOTE: To properly position the speakers, secure the rubber grommets into the hooks.
2. Route the speaker cable along the bottom side of the palm-rest and keyboard assembly. Then secure the speaker cable into the routing guides on the palm-rest and keyboard assembly.
3. Replace the four screws (M2x2) that secures the speakers in place.
4. Adhere the tape that secures the speaker cable to the palm-rest and keyboard assembly.

5. Connect the speaker cable to the connector on the left I/O-board.
6. Connect the antenna cables and replace the WWAN-card bracket.
7. Tighten the captive screw that secures the antenna cables to the WWAN-card bracket.

Next steps

1. Install the [WWAN card](#).
2. Install the [base cover](#).
3. Install the [nano-SIM card](#).
4. Install the [nano-SIM card tray](#).
5. Follow the procedure in [After working inside your computer](#).

Heat sink

Removing the heat sink

CAUTION: The information in this section is intended for authorized service technicians only.

Prerequisites

1. Follow the procedure in [Before working inside your computer](#).
2. Remove the [base cover](#).

About this task

- NOTE:** The heat sink may become hot during normal operation. Allow sufficient time for the heat sink to cool before you touch it.
- NOTE:** For maximum cooling of the processor, do not touch the heat transfer areas on the heat sink. The oils in your skin can reduce the heat transfer capability of the thermal grease.

The following image indicates the location of the battery and provides a visual representation of the removal procedure.

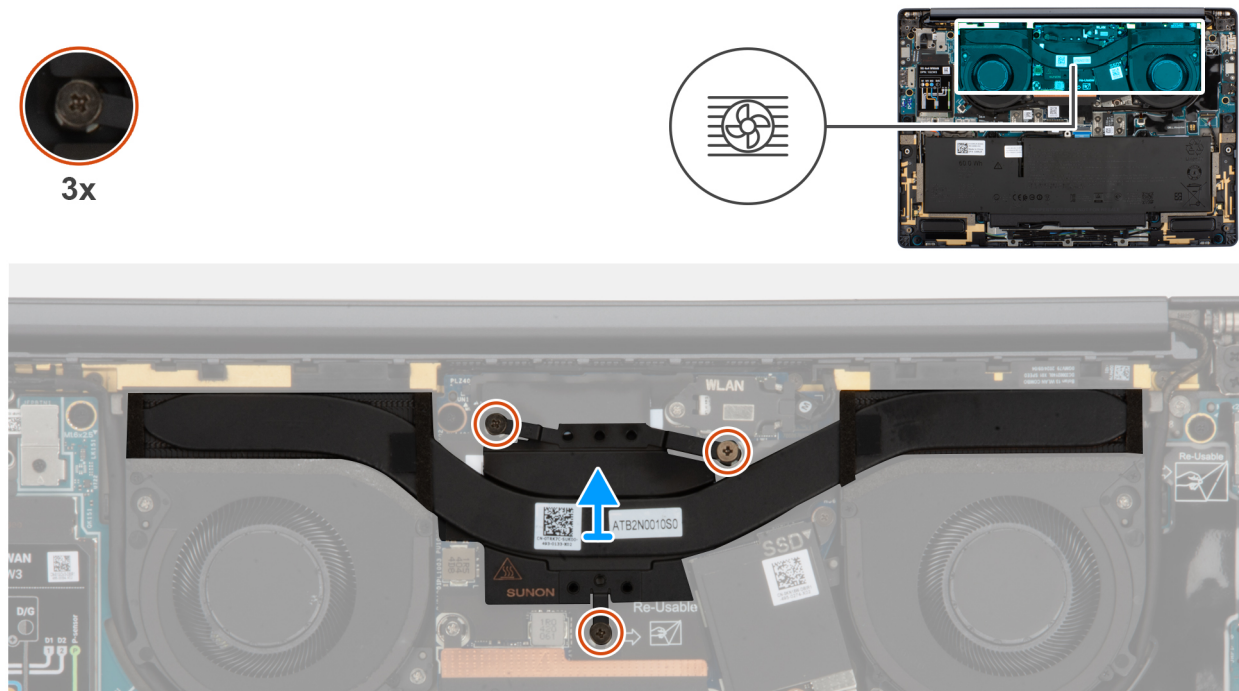

Figure 36. Removing the heat sink

Steps

1. In reverse sequential order (3>2>1), loosen the three captive screws that secure the heat sink to the system board.
2. Lift the heat sink off the system board.

Installing the heat sink

CAUTION: The information in this section is intended for authorized service technicians only.

Prerequisites

If you are replacing a component, remove the existing component before performing the installation process.

About this task

The following image indicates the location of the heat sink and provides a visual representation of the installation procedure.

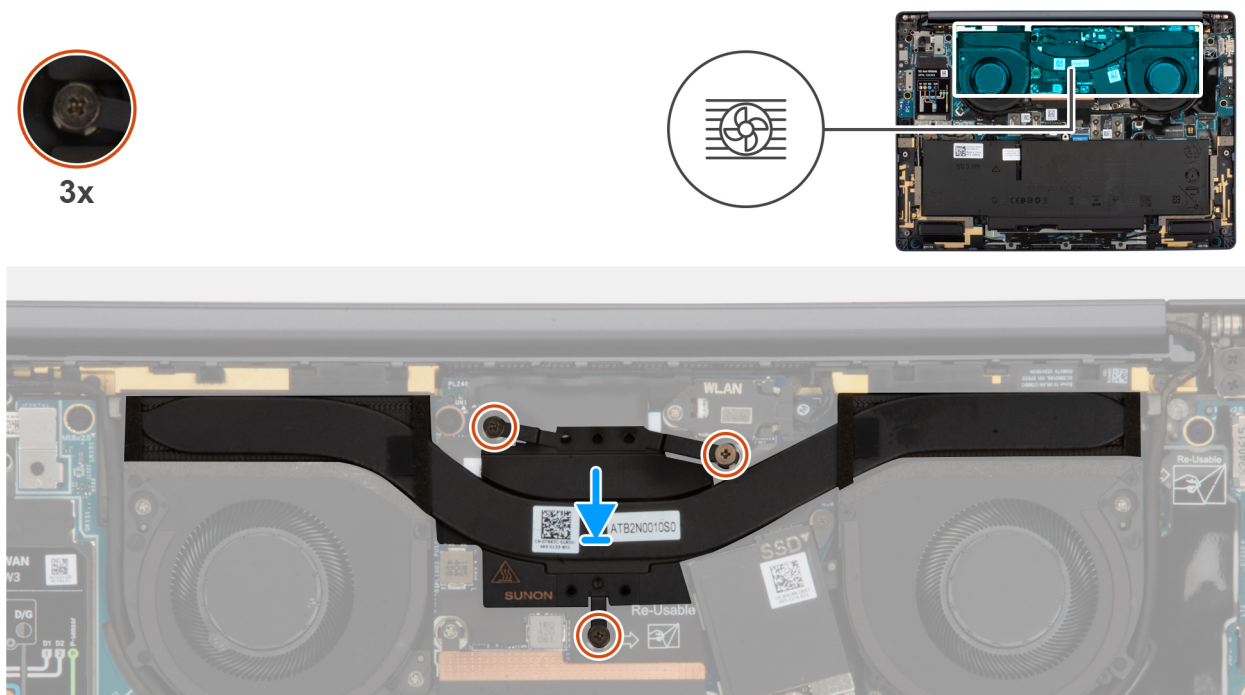

Figure 37. Installing the heat sink

Steps

1. Place the heat sink on the system board.
 - NOTE:** You must apply the XPG gel to the DRAMs of the CPU package.
2. Align the screw holes on the heat sink with the screw holes on the system board.
3. In sequential order (1>2>3) tighten the three captive screws that secure the heat sink to the system board.

Next steps

1. Install the [base cover](#).
2. Follow the procedure in [After working inside your computer](#).

I/O board

Removing the left I/O-board

CAUTION: The information in this section is intended for authorized service technicians only.

Prerequisites

1. Follow the procedure in [Before working inside your computer](#).
2. Remove the [base cover](#).

About this task

The following image indicates the location of the left I/O-board and provides a visual representation of the removal procedure.

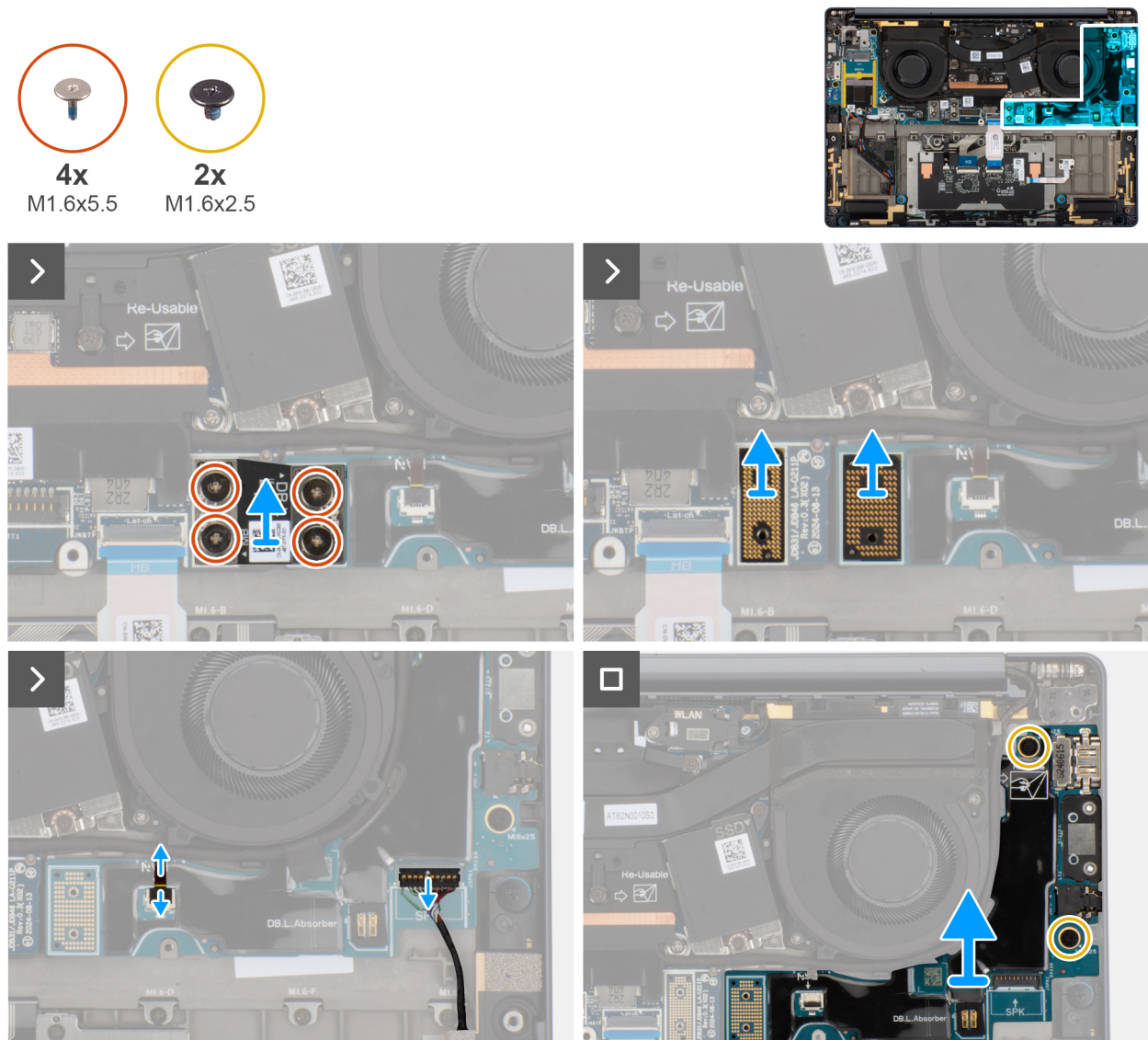

Figure 38. Removing the left I/O-board

Steps

1. Remove the four screws (M1.6x5.5) that secure the left I/O-board connector to the system board.
2. Remove the left I/O-board connector from the system board.

3. Remove the two interposer boards from the left-I/O board and system board.

CAUTION: Technicians must remove the interposer board immediately after removing the I/O-board connector to prevent the board from falling out of the system during subsequent removal procedures.

NOTE: The pins on the interposer board are fragile. Avoid contact with the pins on the board, instead handle the board by lifting and holding from the edges or the sides.

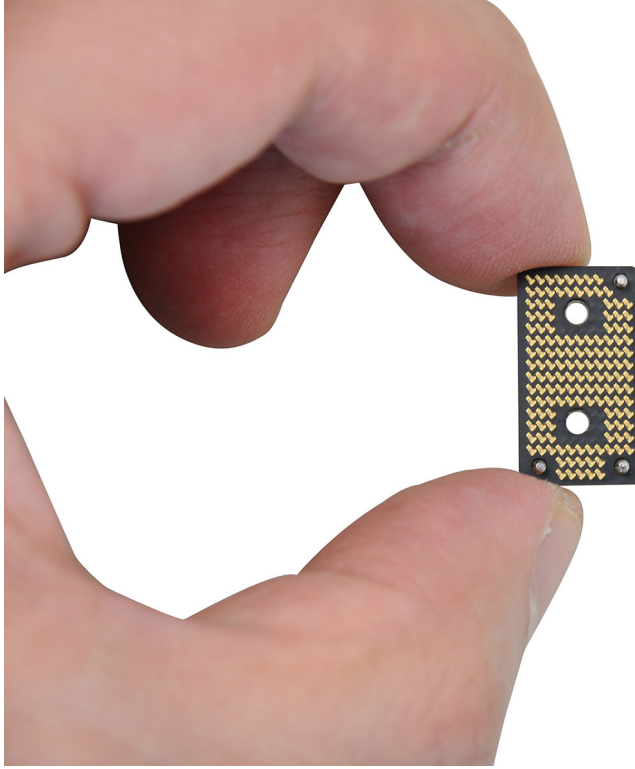

Figure 39. Interposer board handling

4. Disconnect and remove the speaker cable and left-fan cable from the left I/O-board.

5. Remove the two screws (M1.6x2.5) that secure the left I/O-board on the palm-rest and keyboard assembly.

6. Lift to remove the left I/O-board off the palm-rest and keyboard assembly.

NOTE: When replacing the left I/O-board, ensure that the left USB Type-C module is removed and transferred to the new replacement left I/O-board.

Installing the left I/O-board

CAUTION: The information in this section is intended for authorized service technicians only.

Prerequisites

If you are replacing a component, remove the existing component before performing the installation process.

About this task

The following image indicates the location of the left I/O-board and provides a visual representation of the installation procedure.

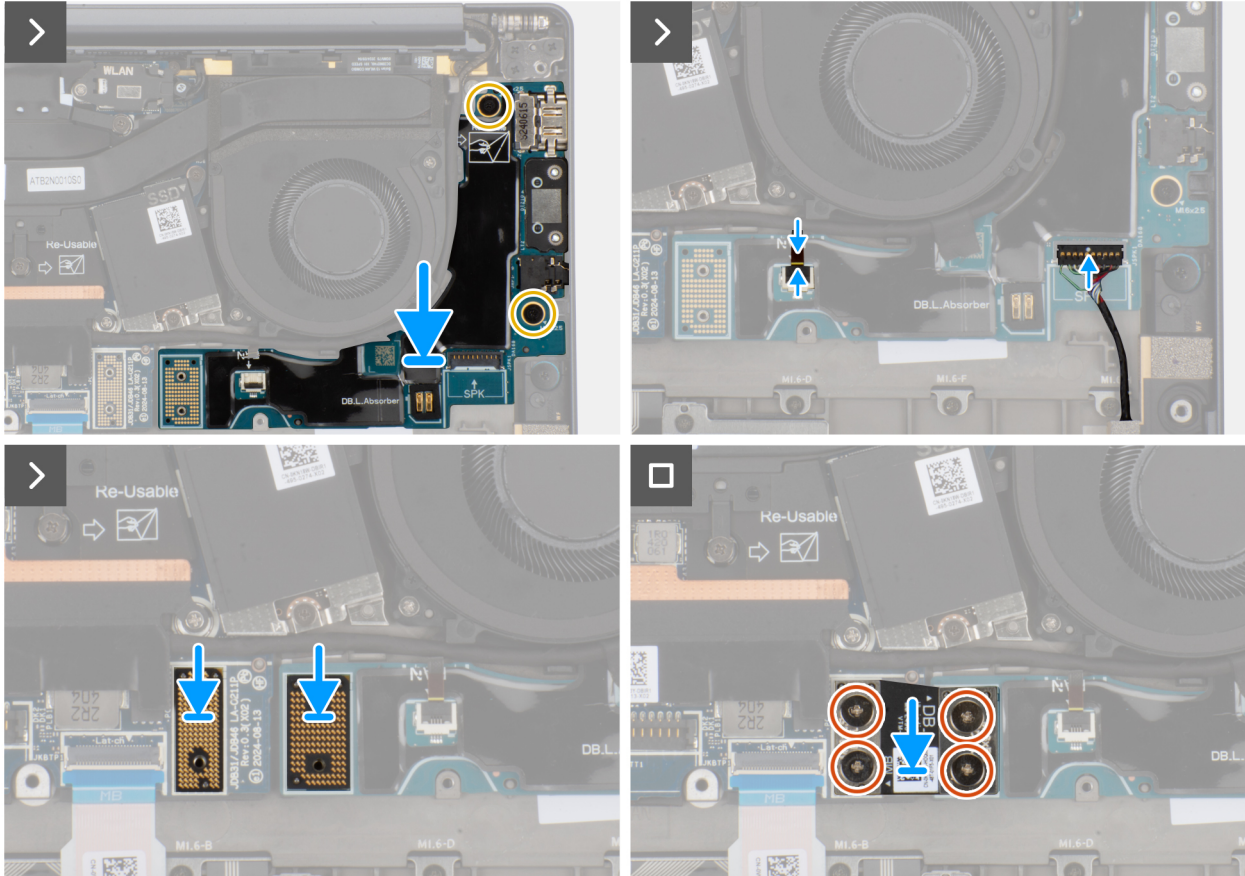
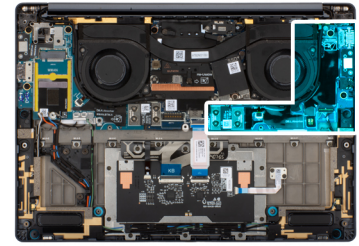
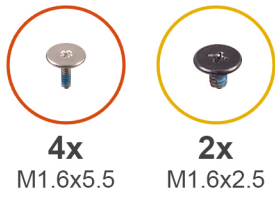

Figure 40. Installing the left I/O-board

Steps

1. Place the left I/O-board on the palm-rest and keyboard assembly.
2. Align the screw holes on the left I/O-board with the screw holes on the palm-rest and keyboard assembly.
3. Replace the two screws (M1.6x2.5) that secure the left I/O-board on the palm-rest and keyboard assembly.
4. Connect the speaker cable and left-fan cable to the left I/O-board.
5. Replace the two interposer boards from the left-I/O board and system board.

NOTE: The pins on the interposer board are fragile. Avoid contact with the pins on the board, instead handle the board by lifting and holding from the edges or the sides.

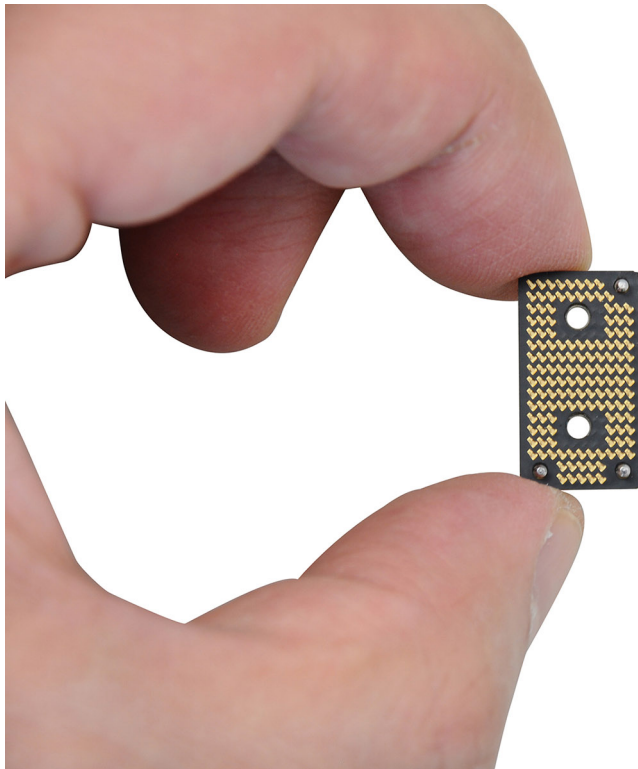

Figure 41. Holding the interposer board

6. Replace the left I/O-board connector on the system board.
7. Replace the four screws (M1.6x5.5) that secure the left I/O-board connector on the system board.

Next steps

1. Install the [base cover](#).
2. Follow the procedure in [After working inside your computer](#).

Removing the right I/O-board (without WWAN antennas)

 **CAUTION:** The information in this section is intended for authorized service technicians only.

Prerequisites

1. Follow the procedure in [Before working inside your computer](#).
2. Remove the [nano-SIM tray](#).
3. Remove the [nano-SIM card](#).
4. Remove the [base cover](#).

About this task

The following image indicates the location of the right I/O-board and provides a visual representation of the removal procedure.

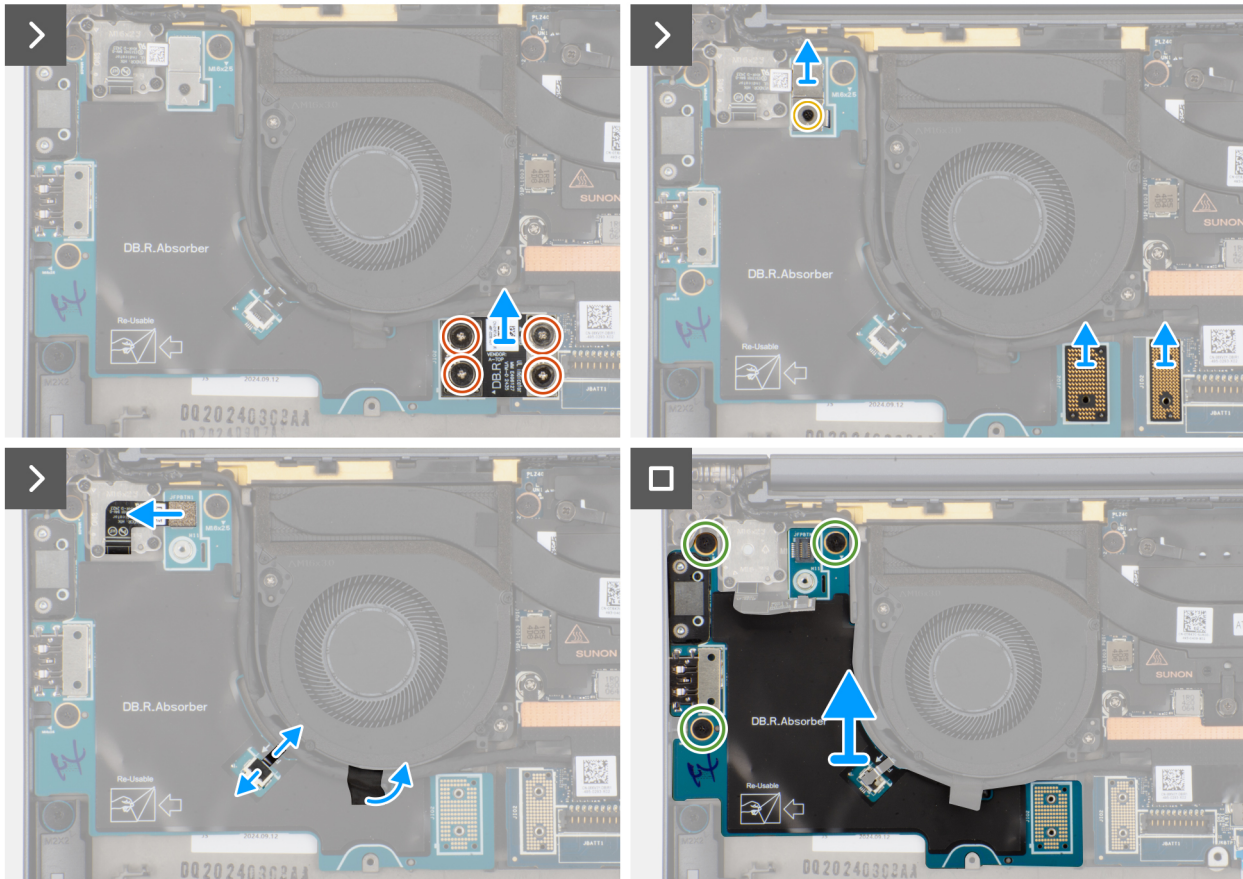
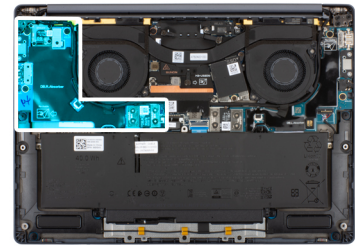
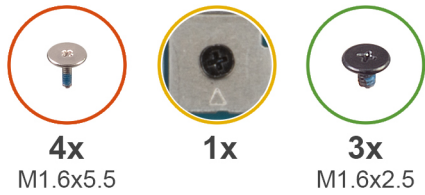

Figure 42. Removing the right I/O-board (without WWAN antennas)

Steps

1. Remove the four screws (M1.6x5.5) that secure the right I/O-board connector on the system board.
2. Remove the two interposer boards from the left-I/O board and system board.

CAUTION: Technicians must remove the interposer board immediately after removing the I/O-board connector to prevent the board from falling out of the system during subsequent removal procedures.

NOTE: The pins on the interposer board are fragile. Avoid contact with the pins on the board, instead handle the board by lifting and holding from the edges or the sides.

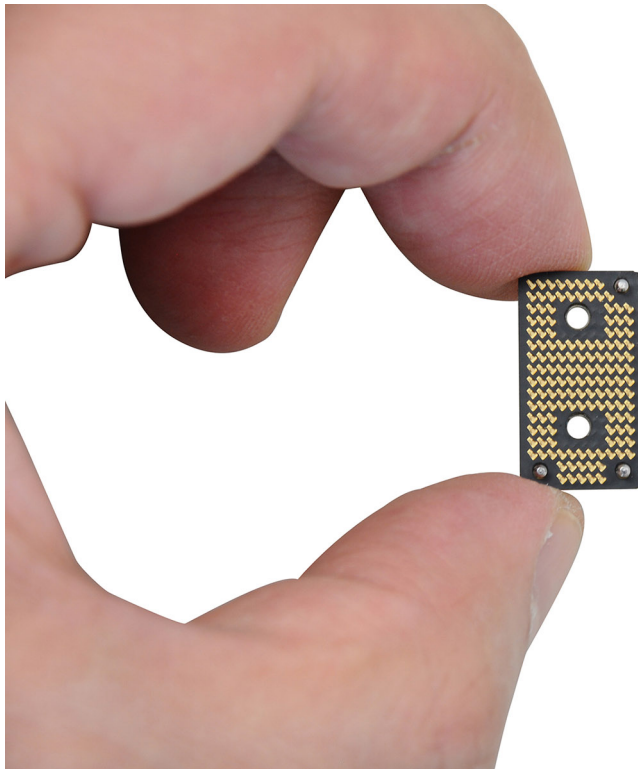

Figure 43. Holding the interposer board

3. Loosen the single captive screw that secures the power button connector bracket on the palm-rest and keyboard assembly .
4. Remove the power-button connector bracket from the system board.
5. Remove the right I/O-board connector from the system board.
6. Disconnect the right-fan cable connector from the right I/O-board.
7. Remove the three screws (M1.6x2.5) that secure the right I/O-board on the palm-rest and keyboard assembly.
8. Lift to remove the right I/O-board off the palm-rest and keyboard assembly.

NOTE: When replacing the right I/O-board, ensure that the right USB Type-C module is removed and transferred to the new replacement right I/O-board.

Installing the right I/O-board (without WWAN antennas)

CAUTION: The information in this section is intended for authorized service technicians only.

Prerequisites

If you are replacing a component, remove the existing component before performing the installation process.

About this task

The following image indicates the location of the right I/O-board and provides a visual representation of the installation procedure.

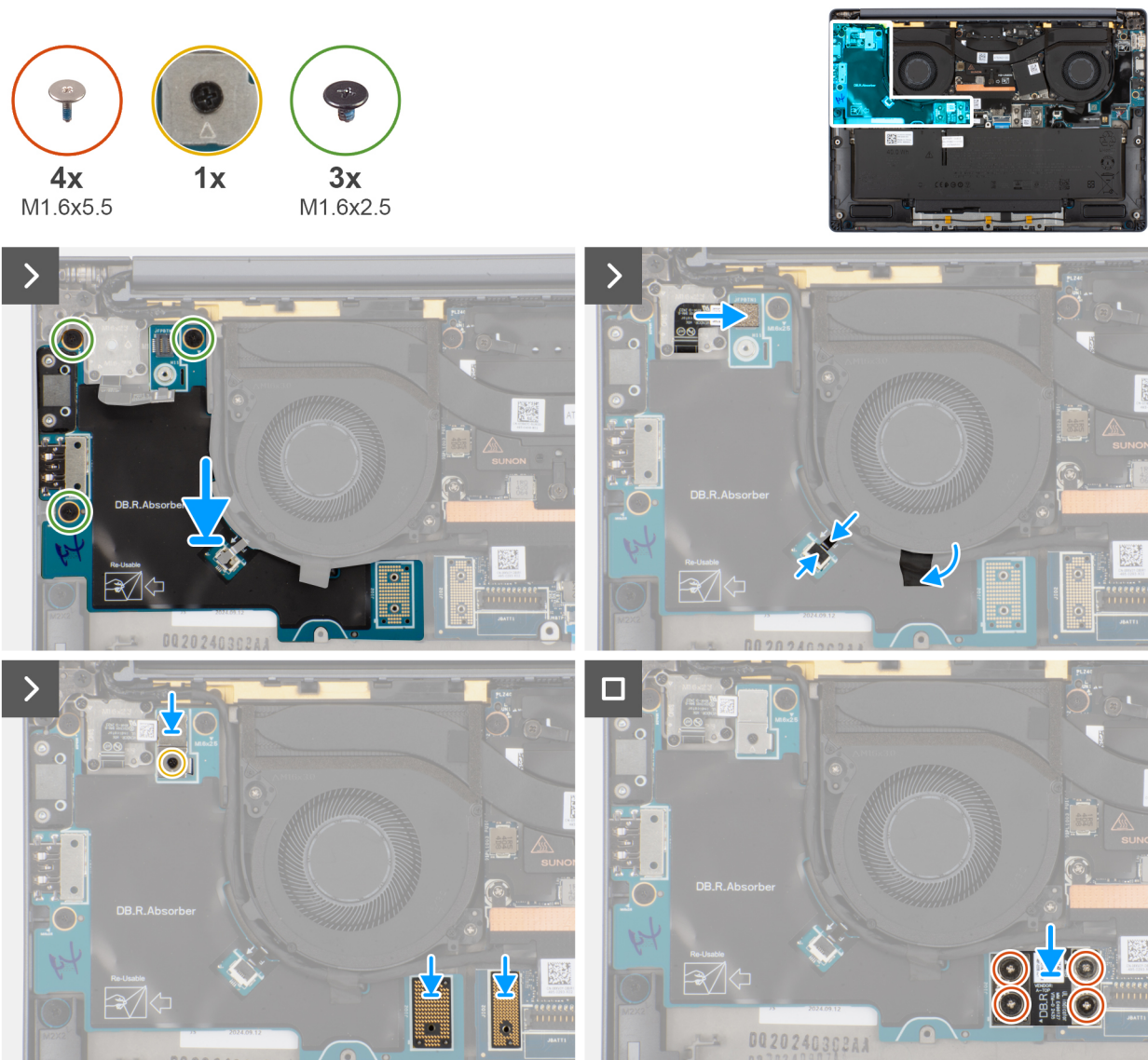

Figure 44. Installing the right I/O-board (without WWAN antennas)

Steps

1. Place the right I/O-board on the palm-rest and keyboard assembly.
2. Align the screw holes on the right I/O-board with the screw holes on the palm-rest and keyboard assembly.
3. Replace the three screws (M1.6x2.5) that secure the right I/O-board on the palm-rest and keyboard assembly.
4. Connect the right-fan cable connector to the right I/O-board.
5. Replace the right I/O-board connector to the system board.
6. Replace the power-button connector bracket on the system board.
7. Tighten the single captive screw that secures the power button connector bracket on the palm-rest and keyboard assembly .
8. Replace the two interposer boards from the right-I/O board and system board.

NOTE: The pins on the interposer board are fragile. Avoid contact with the pins on the board, instead handle the board by lifting and holding from the edges or the sides.

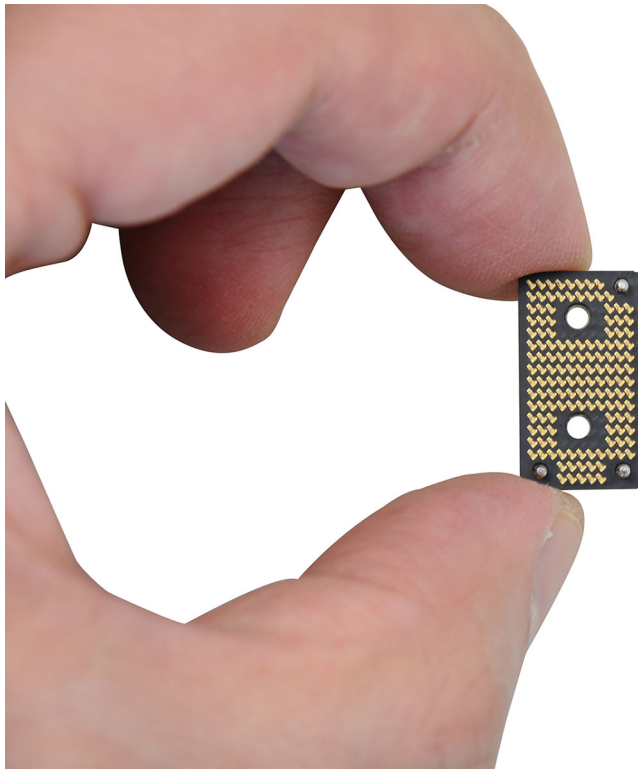

Figure 45. Holding the interposer board

9. Replace the four screws (M1.6x5.5) that secure the right I/O-board connector on the system board.

Next steps

1. Install the [base cover](#).
2. Install the [nano-SIM card](#).
3. Install the [nano-SIM card tray](#).
4. Follow the procedure in [After working inside your computer](#).

Removing the right I/O-board (with WWAN antennas)

⚠ CAUTION: The information in this section is intended for authorized service technicians only.

Prerequisites

1. Follow the procedure in [Before working inside your computer](#).
2. Remove the [nano-SIM card tray](#).
3. Remove the [nano-SIM card](#).
4. Remove the [base cover](#).
5. Remove the [WWAN card](#).

About this task

The following image indicates the location of the right I/O-board and provides a visual representation of the removal procedure.

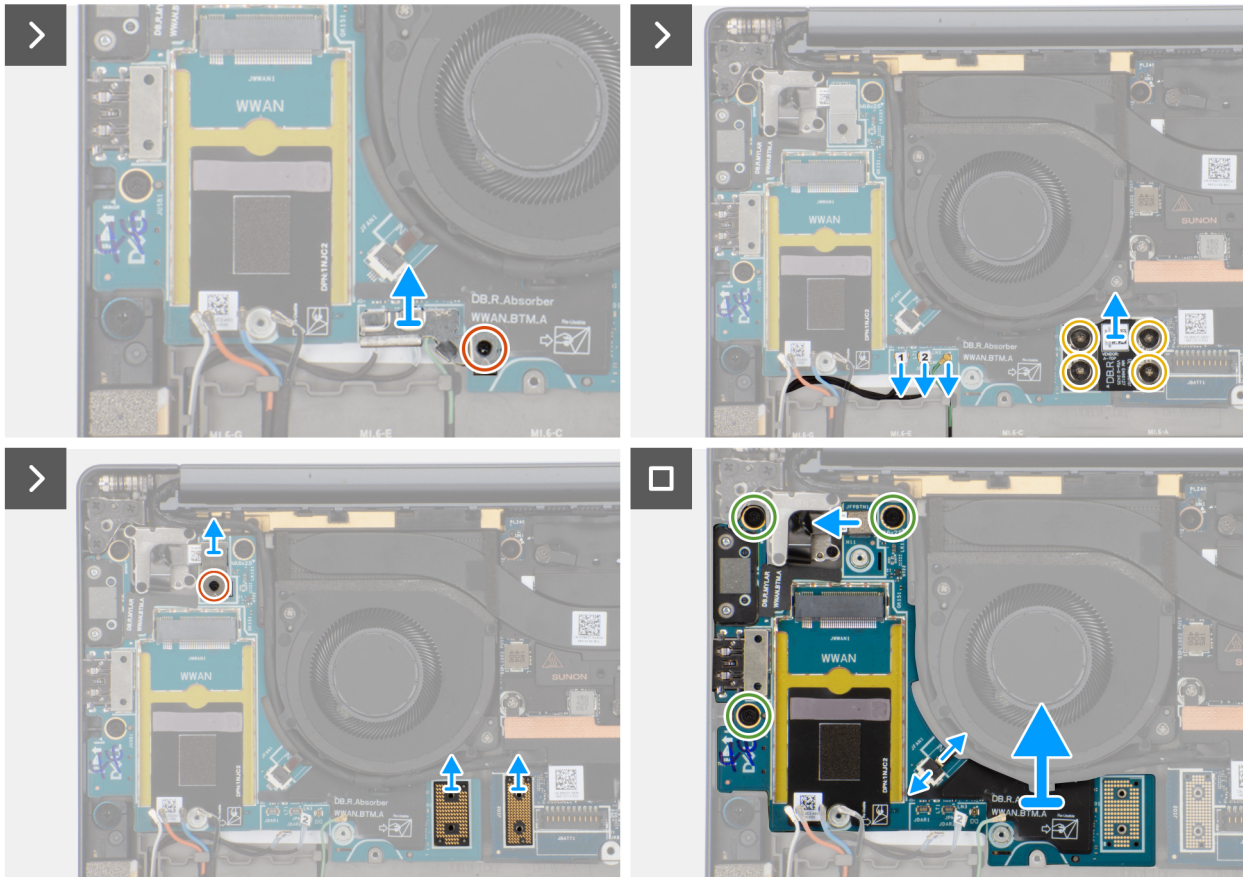
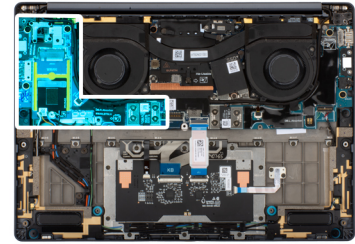
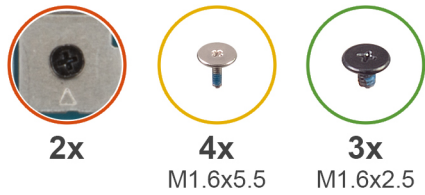

Figure 46. Removing the right I/O-board (with WWAN)

Steps

1. Loosen the single captive screw that secures the Darwin antenna-cable bracket.
2. Remove the Darwin antenna-cable bracket from the computer.
3. Disconnect the antenna cables from the right I/O-board.
4. Remove the four screws (M1.6x5.5) that secure the right I/O-board connector on the system board.
5. Remove the two interposer boards from the left-I/O board and system board.

CAUTION: Technicians must remove the interposer board immediately after removing the I/O-board connector to prevent the board from falling out of the computer during subsequent removal procedures.

NOTE: The pins on the interposer board are fragile. Avoid contact with the pins on the board, instead handle the board by lifting and holding from the edges or the sides.

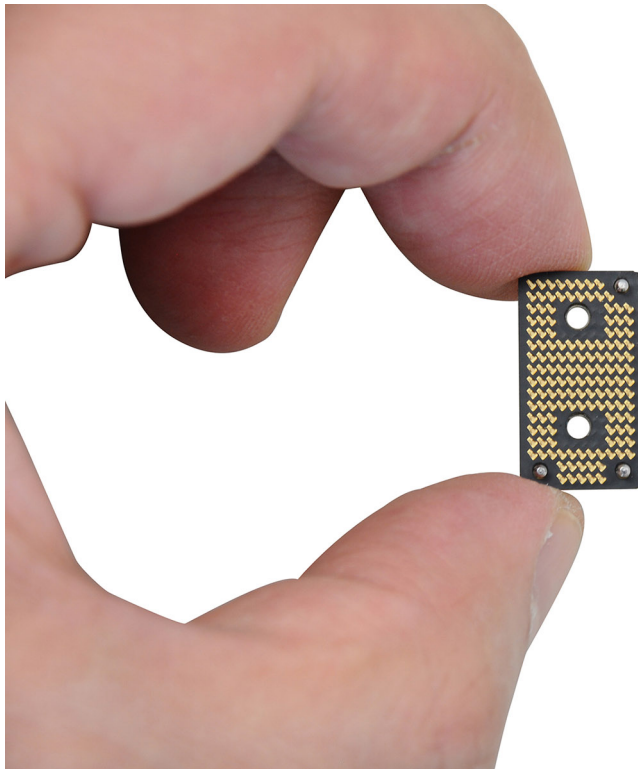

Figure 47. Holding the interposer board

6. Loosen the single captive screw that secures the power button connector bracket on the palm-rest and keyboard assembly .
7. Remove the power-button connector bracket from the system board.
8. Remove the right I/O-board connector from the system board.
9. Disconnect the right-fan cable connector from the right I/O-board.
10. Remove the three screws (M1.6x2.5) that secure the right I/O-board on the palm-rest and keyboard assembly.
11. Lift to remove the right I/O-board off the palm-rest and keyboard assembly.

NOTE: When replacing the right I/O-board, ensure that the right USB Type-C module is removed and transferred to the new replacement right I/O-board.

Installing the right I/O-board (with WWAN antennas)

CAUTION: The information in this section is intended for authorized service technicians only.

Prerequisites

If you are replacing a component, remove the existing component before performing the installation process.

About this task

The following image indicates the location of the right I/O-board and provides a visual representation of the installation procedure.

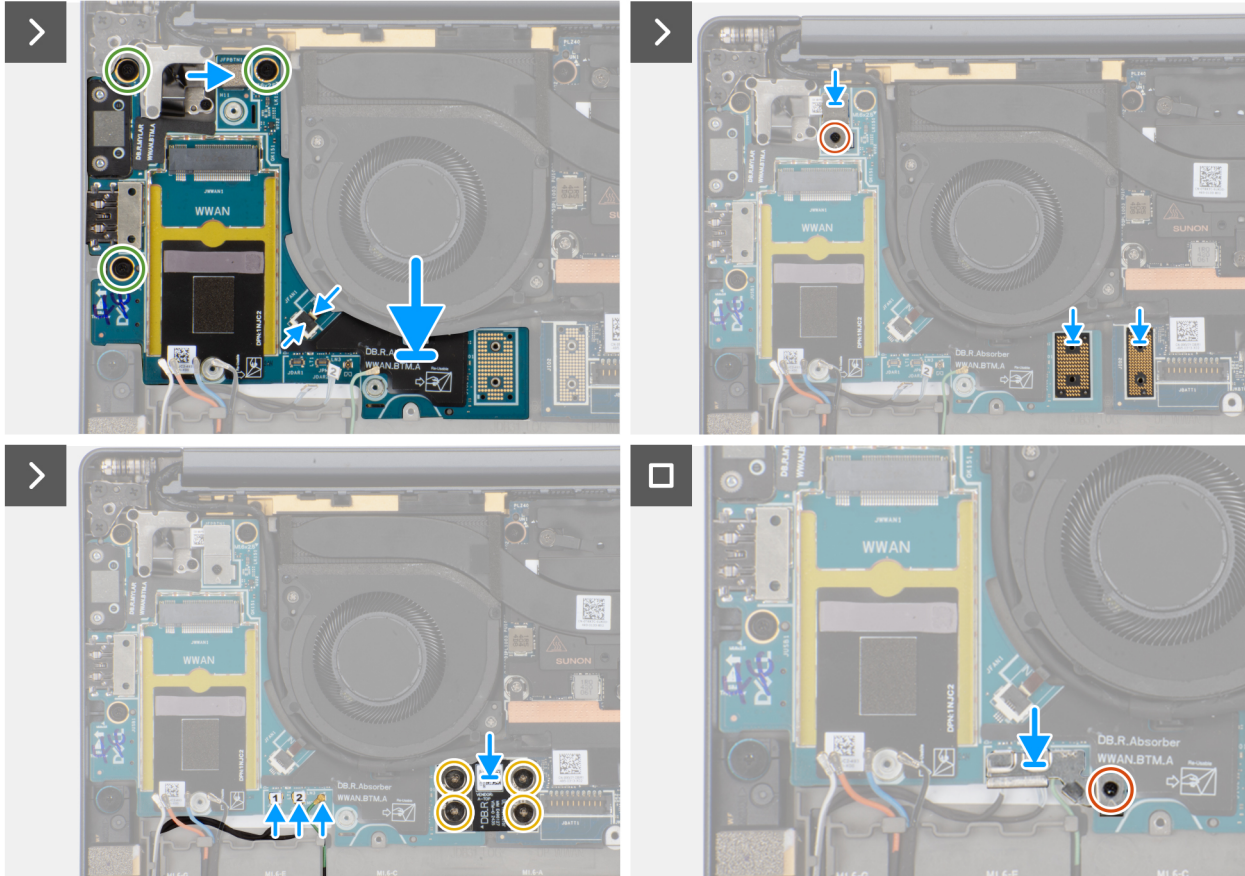
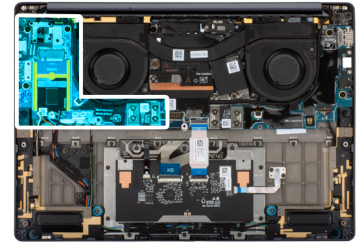
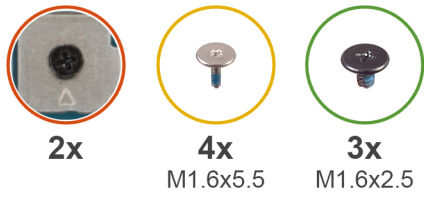

Figure 48. Installing the right I/O-board (with WWAN)

Steps

1. Place the right I/O-board on the palm-rest and keyboard assembly.
2. Align the screw holes on the right I/O-board with the screw holes on the palm-rest and keyboard assembly.
3. Replace the three screws (M1.6x2.5) that secure the right I/O-board on the palm-rest and keyboard assembly.
4. Connect the right-fan cable connector to the right I/O-board.
5. Replace the right I/O-board connector to the system board.
6. Replace the power-button connector bracket on the system board.
7. Tighten the single captive screw that secures the power button connector bracket on the palm-rest and keyboard assembly .
8. Replace the two interposer boards from the right I/O-board and system board.

NOTE: The pins on the interposer board are fragile. Avoid contact with the pins on the board, instead handle the board by lifting and holding from the edges or the sides.

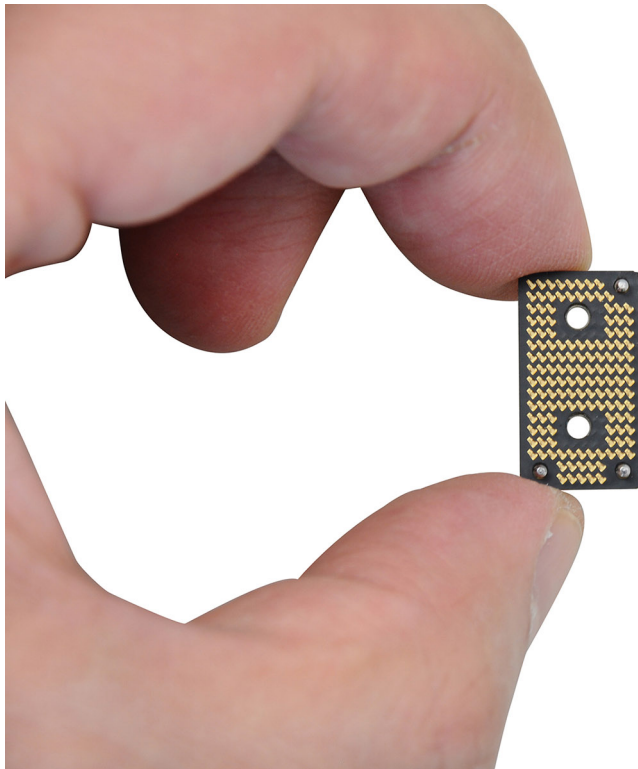

Figure 49. Holding the interposer board

9. Replace the four screws (M1.6x5.5) that secure the right I/O-board connector on the system board.
10. Connect the antenna cables to the right I/O-board.
11. Replace the Darwin antenna-cable bracket on the computer.
12. Tighten the single captive screw that secures the Darwin antenna-cable bracket.

Next steps

1. Install the [WWAN card](#).
2. Install the [base cover](#).
3. Install the [nano-SIM card](#).
4. Install the [nano-SIM card tray](#).
5. Follow the procedure in [After working inside your computer](#).

USB Type-C module

Removing the left USB Type-C module

 **CAUTION:** The information in this section is intended for authorized service technicians only.

Prerequisites

1. Follow the procedure in [Before working inside your computer](#).
2. Remove the [base cover](#).
3. Remove the [left I/O-board](#).

About this task

The following image indicates the location of the left USB Type-C module and provides a visual representation of the removal procedure.



Figure 50. Removing the left USB Type-C module

Steps

1. Remove the two screws (M2x5) that secure the left USB Type-C module to the left I/O-board.
2. Lift the left USB Type-C module off the left I/O-board.

Installing the left USB Type-C module

CAUTION: The information in this section is intended for authorized service technicians only.

About this task

The following image indicates the location of the left Type-C USB module and provides a visual representation of the installation procedure.



Figure 51. Installing the left USB Type-C module

If you are replacing a component, remove the existing component before performing the installation process.

Steps

1. Place the left USB Type-C module on the left I/O-board.
2. Align the screw holes on the left USB Type-C module with the screw holes on the left I/O-board.
3. Replace the two screws (M2x5) that secure the left USB Type-C module to the left I/O-board.

Next steps

1. Install the [left I/O-board](#).
2. Install the [base cover](#).
3. Follow the procedure in [After working inside your computer](#).

Removing the right USB Type-C module

CAUTION: The information in this section is intended for authorized service technicians only.

Prerequisites

1. Follow the procedure in [Before working inside your computer](#).
2. Remove the [nano-SIM card tray](#).
3. Remove the [nano-SIM card](#).
4. Remove the [base cover](#).
5. Remove the [WWAN card](#) (for the computer shipped with WWAN card).
6. Remove the [right I/O-board](#) (for the computer shipped with WWAN card).
7. Remove the [right I/O-board](#) (for the computer shipped without WWAN card).

About this task

The following image indicates the location of the right USB Type-C module and provides a visual representation of the removal procedure.



2x
M2x5

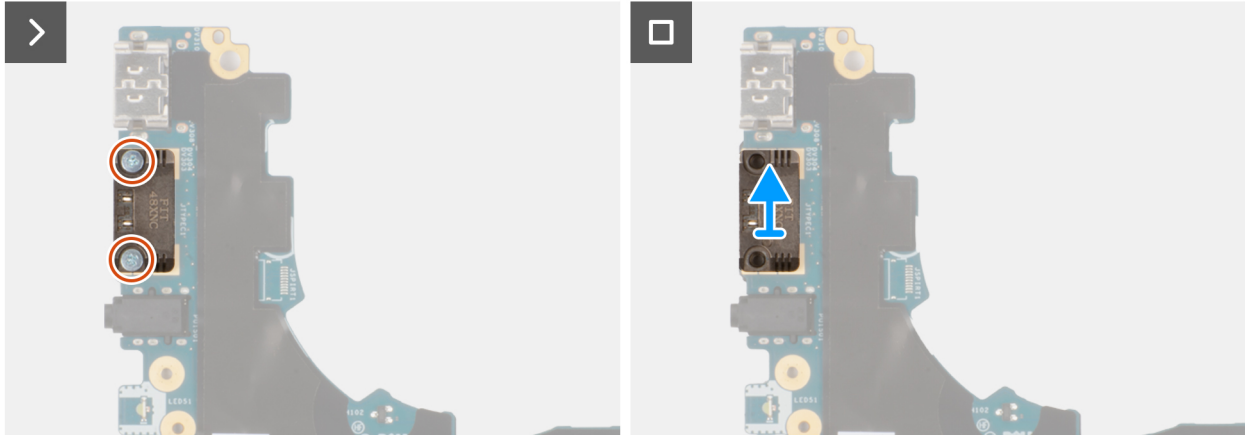
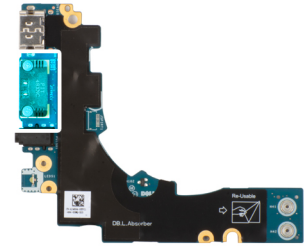

Figure 52. Removing the right USB Type-C module

Steps

1. Remove the two screws (M2x5) that secure the right USB Type-C module to the right I/O-board.
2. Lift the right USB Type-C module off the right I/O-board.

Installing the right USB Type-C module

CAUTION: The information in this section is intended for authorized service technicians only.

About this task

The following image indicates the location of the right USB Type-C module and provides a visual representation of the installation procedure.



2x
M2x5

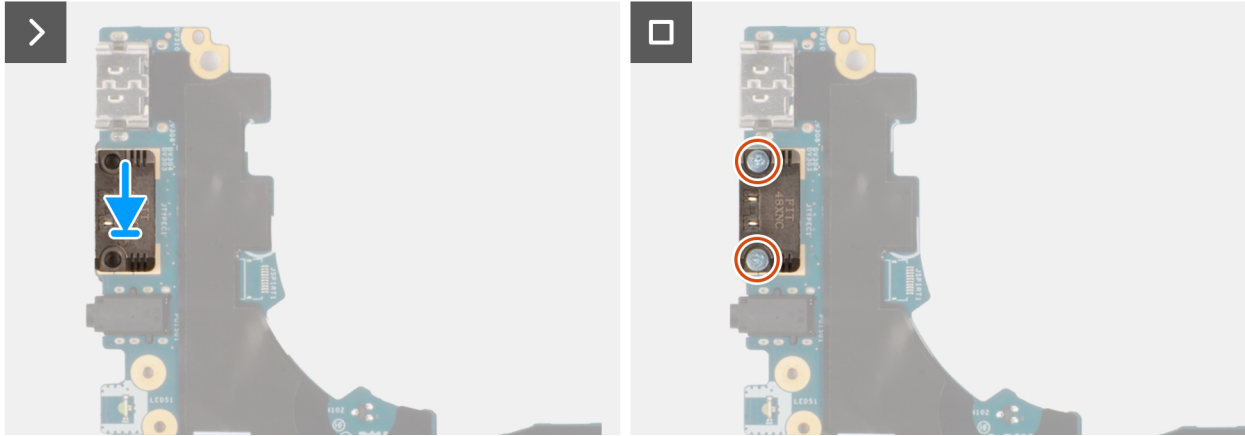
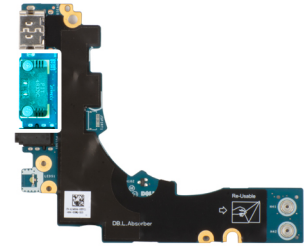

Figure 53. Installing the right USB Type-C module

If you are replacing a component, remove the existing component before performing the installation process.

Steps

1. Place the right USB Type-C module on the right I/O-board.
2. Align the screw holes on the right USB Type-C module with the screw holes on the right I/O-board.
3. Replace the screw (M2x5) that secure the right USB Type-C module to the right I/O-board.

Next steps

1. Install the [right I/O-board](#) (for the computer shipped without WWAN card)..
2. Install the [right I/O-board](#) (for the computer shipped with WWAN card).
3. Install the [WWAN card](#) (for the computer shipped with WWAN card).
4. Install the [base cover](#).
5. Install the [nano-SIM card](#).
6. Install the [nano-SIM card tray](#).
7. Follow the procedure in [After working inside your computer](#).

Power button

Removing the power button

 **CAUTION:** The information in this section is intended for authorized service technicians only.

Prerequisites

1. Follow the procedure in [Before working inside your computer](#).
2. Remove the [nano-SIM card tray](#).
3. Remove the [nano-SIM card](#).
4. Remove the [base cover](#).
5. Remove the [WWAN card](#) (for the computer shipped with WWAN card).

6. Remove the [right I/O-board](#) (for the computer shipped with WWAN card).
7. Remove the [right I/O-board](#) (for the computer shipped without WWAN card).

About this task

NOTE: This procedure is applicable only for computers that are shipped without the optional fingerprint reader.

The following image indicates the location of the power button and provides a visual representation of the removal procedure.

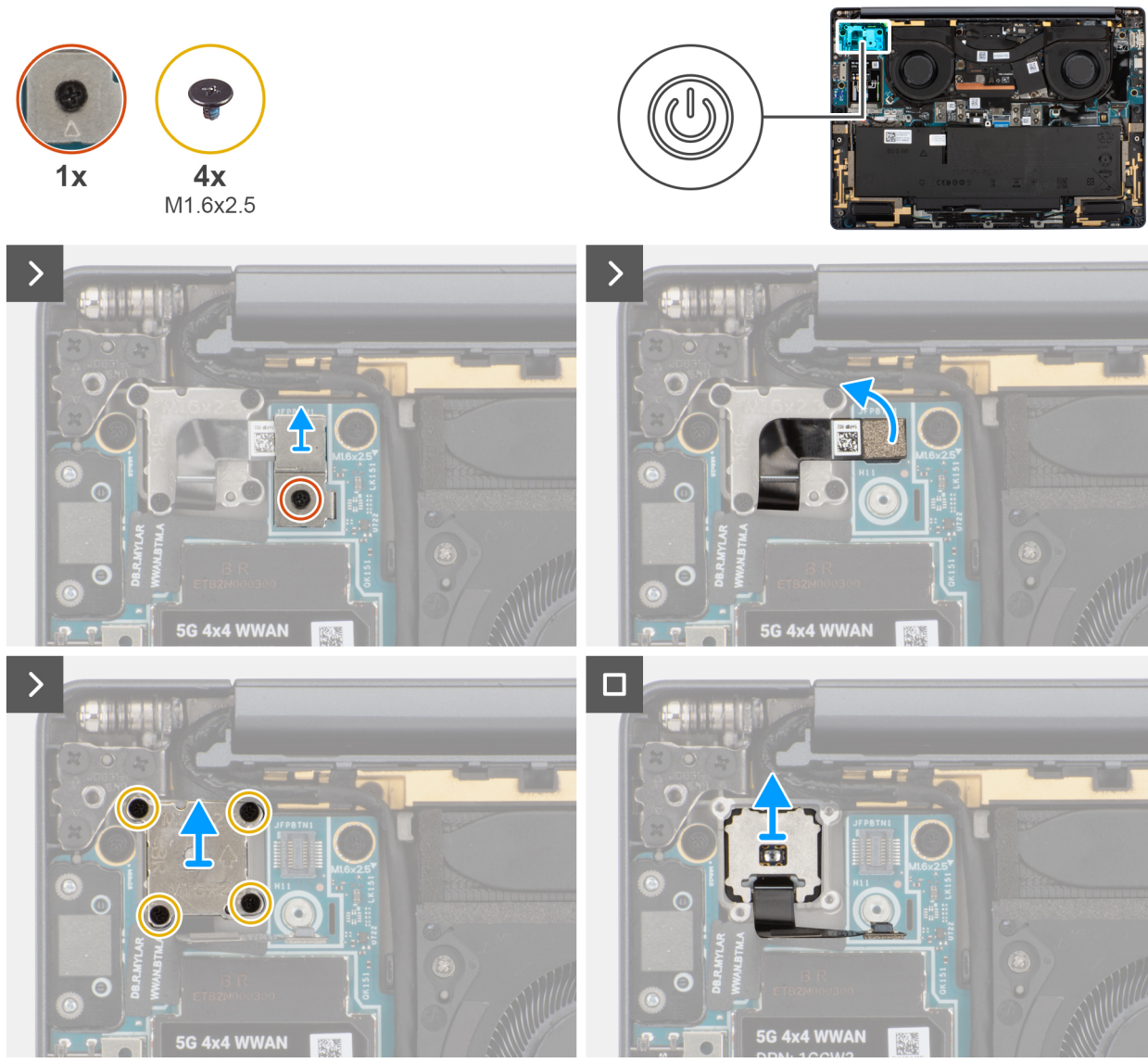

Figure 54. Removing the power button

Steps

1. Loosen the single captive screw that secures the power-button bracket.
2. Remove the power-button bracket from the computer.
3. Disconnect the power-button cable from the right I/O-board.
4. Remove the four screws (M1.6x2.5) that secure the power button bracket with power button cable.
5. Remove the power button bracket with power button cable from the computer.
6. Lift and remove the power button from the computer.

Installing the power button

CAUTION: The information in this section is intended for authorized service technicians only.

Prerequisites

If you are replacing a component, remove the existing component before performing the installation procedure.

About this task

NOTE: This procedure is applicable only when you are installing a power button without the optional fingerprint reader.

The following image indicates the location of the power button and provides a visual representation of the installation procedure.

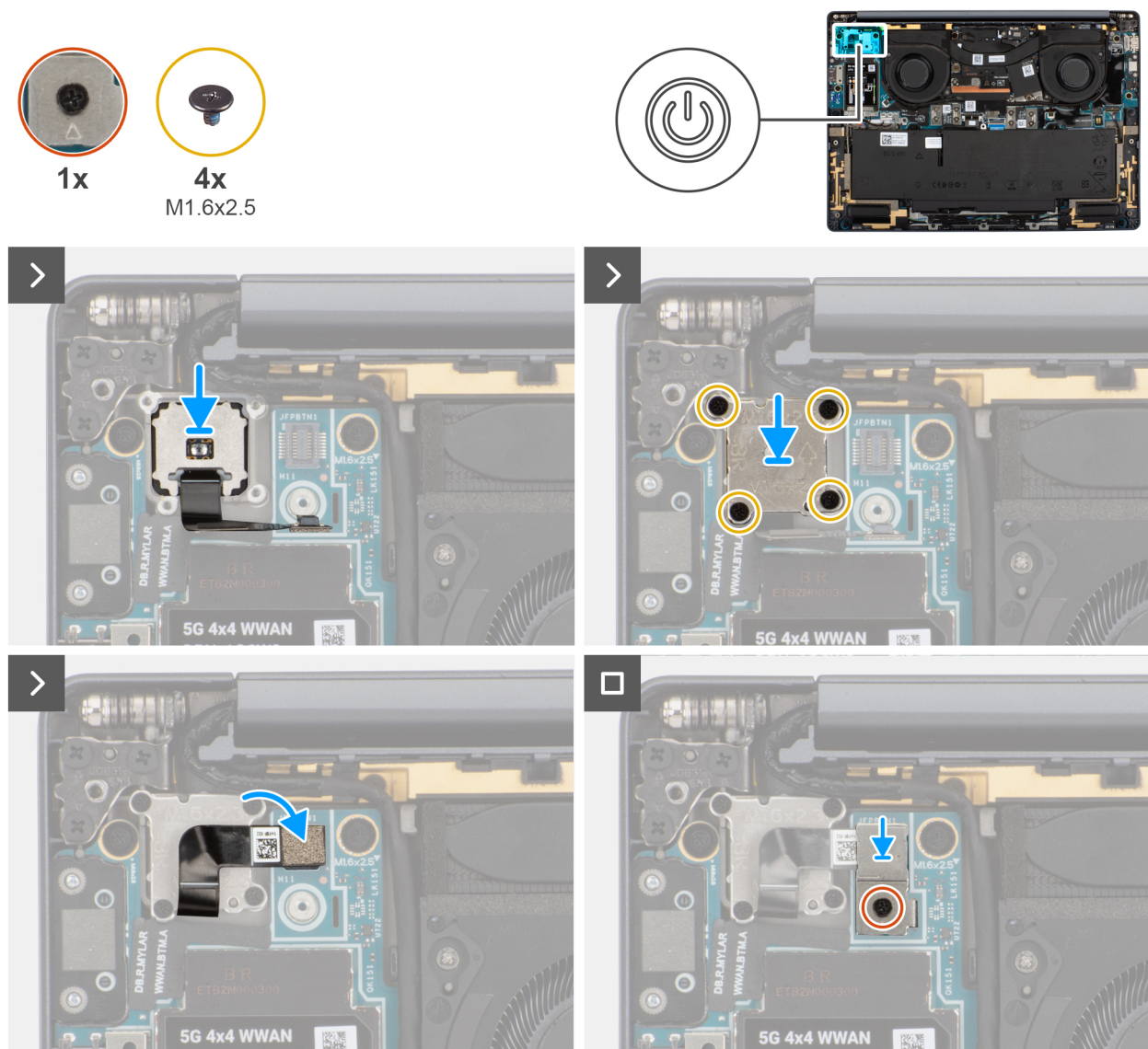

Figure 55. Installing the power button

Steps

1. Place the power button into its slot on the palm-rest and keyboard assembly.
2. Replace the power-button bracket with the power-button cable on the computer.
3. Replace the four screws (M1.6x2.5) that secure the power-button bracket with the power-button cable.

4. Connect the power-button cable to the right I/O-board.
5. Replace the power-button bracket on the computer.
6. Tighten the single captive screw that secures the power-button bracket.

Next steps

1. Install the [right I/O-board](#) (for the computer shipped without WWAN card).
2. Install the [right I/O-board](#) (for the computer shipped with WWAN card).
3. Install the [WWAN card](#) (for the computer shipped with WWAN card).
4. Install the [base cover](#).
5. Install the [nano-SIM card](#).
6. Install the [nano-SIM card tray](#).
7. Follow the procedure in [After working inside your computer](#).

Display assembly

Removing the display assembly

 **CAUTION:** The information in this section is intended for authorized service technicians only.

Prerequisites

1. Follow the procedure in [Before working inside your computer](#).
2. Remove the [base cover](#).

About this task

The following images indicate the location of the display assembly and provide a visual representation of the removal procedure.

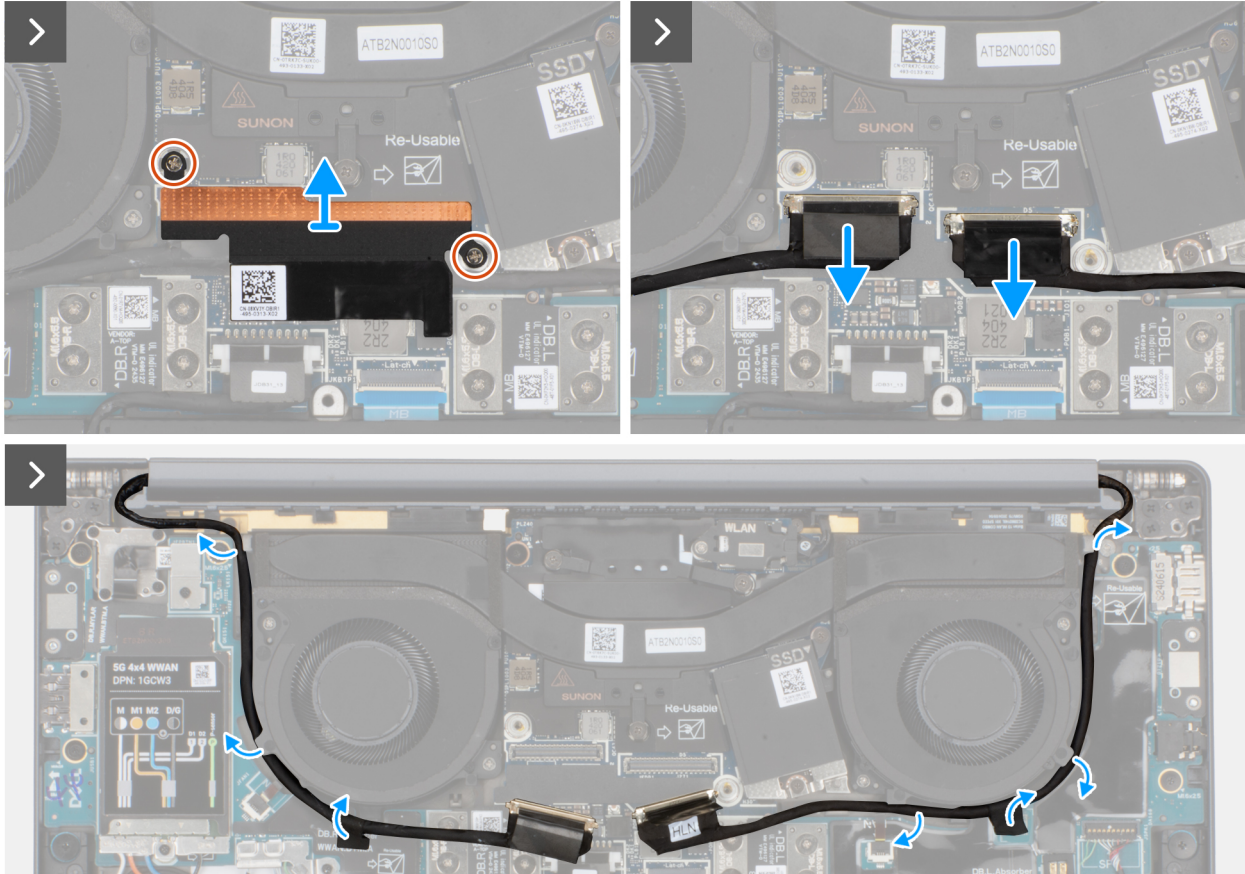
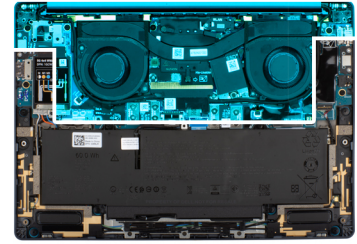
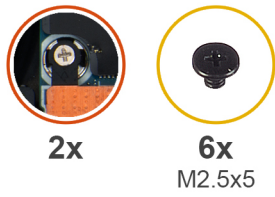

Figure 56. Disconnect the display and camera cables

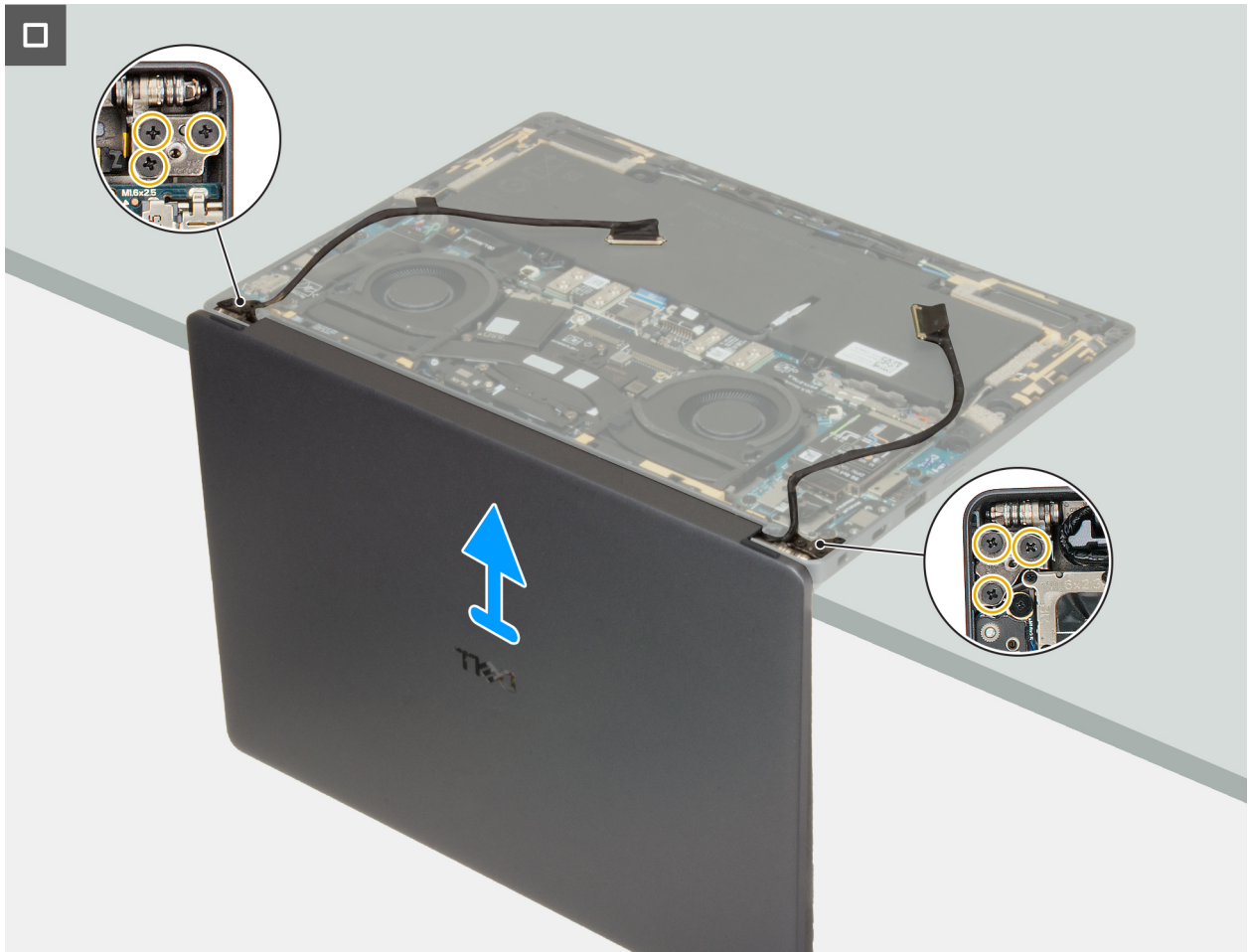

Figure 57. Removing the display assembly



Figure 58. LCD

Steps

1. Remove the two captive screws that secure the display-cable bracket on the system board.
2. Remove the display-cable bracket from the system board.
3. Disconnect and peel off the display cable and camera cable from the system board.
4. Unthread the display cable and camera cable from the routing channels on the bottom side of the fans and the top side of the system board.
5. Pry open the computer to at least 90 degrees and place the system on the edge of a table so that the palm rest is laying flat on the table and the display assembly is over the edge.
6. Remove the six screws (M2.5x5) that secure the display assembly on the palm-rest and keyboard assembly.
7. Lift and remove the display assembly from the computer.

Installing the display assembly

CAUTION: The information in this section is intended for authorized service technicians only.

Prerequisites

If you are replacing a component, remove the existing component before performing the installation procedure.

About this task

NOTE: Ensure that the hinges are opened to the maximum before replacing the display assembly on the palm-rest and keyboard assembly.

The following images indicate the location of the display assembly and provide a visual representation of the installation procedure.



2x



6x
M2.5x5

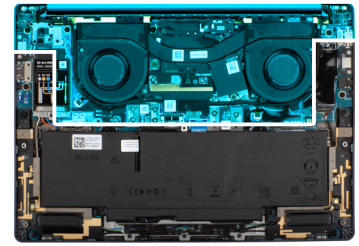

Figure 59. Installing the display assembly

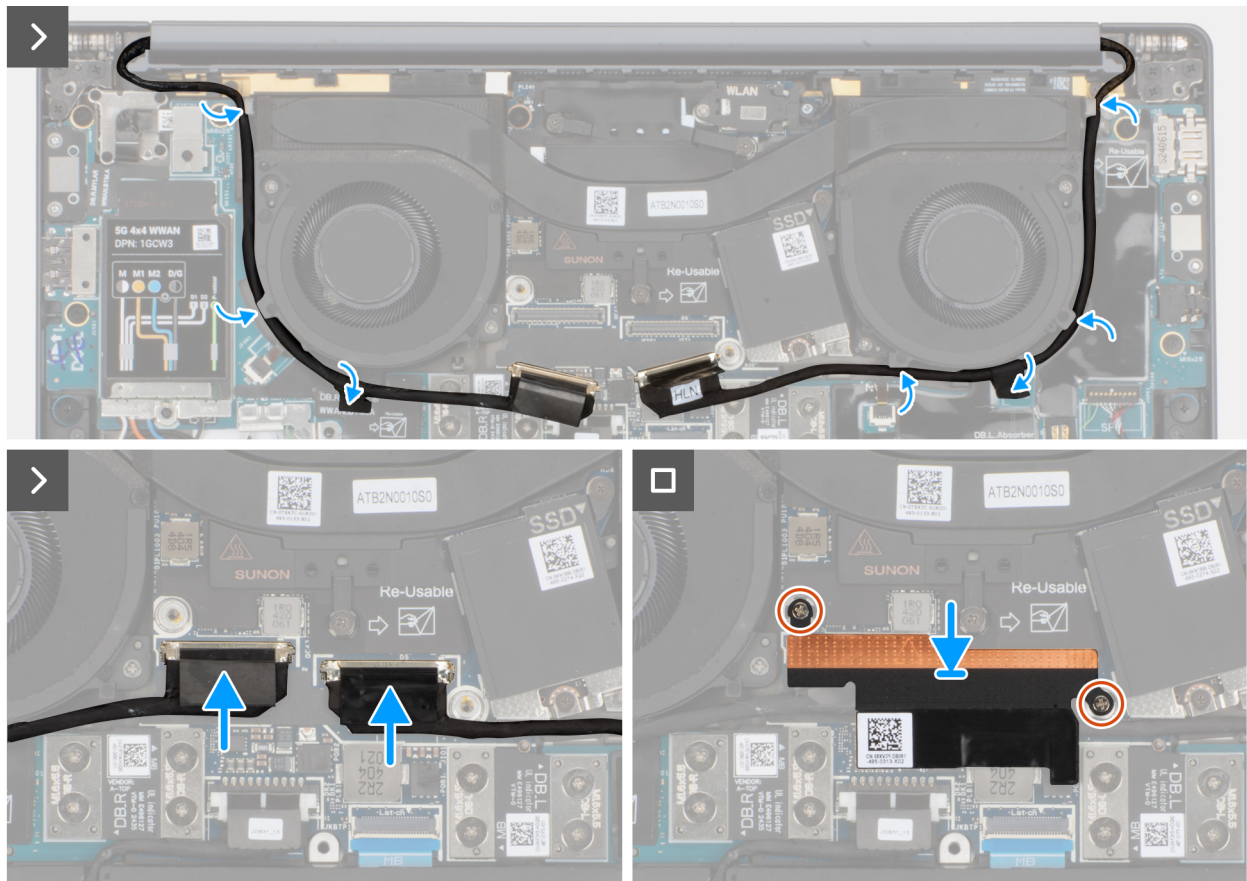

Figure 60. Connecting the display and camera cables

Steps

1. Place the display assembly on a flat surface.
2. Slide the base assembly at an angle and gently press down on then hinges to align the screw holes on the display hinges with screw holes on the system board.
3. Replace the six screws (M2.5x5) that secure the display assembly on the palm-rest and keyboard assembly.
4. Route the display cable and camera cable from the routing channels on the bottom side of the fans and the top side of the system board.
5. Connect the display cable and camera cable to the system board.
6. Place and align the display-cable bracket on the system board.
7. Replace the two captive screws that secure the display-cable bracket on the system board.

Next steps

1. Install the [base cover](#).
2. Follow the procedure in [After working inside your computer](#).

System board

Removing the system board

CAUTION: The information in this section is intended for authorized service technicians only.

Prerequisites

1. Follow the procedure in [Before working inside your computer](#).

2. Remove the [base cover](#).
3. Remove the [M.2 2230 solid state drive](#).
4. Remove the [battery](#).
5. Remove the [heat sink](#).

NOTE: The system board can be removed and installed along with the heat sink. It simplifies the removal and installation procedure and prevents damage to the thermal bond between the system board and heat sink.

About this task

The following image indicates the connectors on your system board.

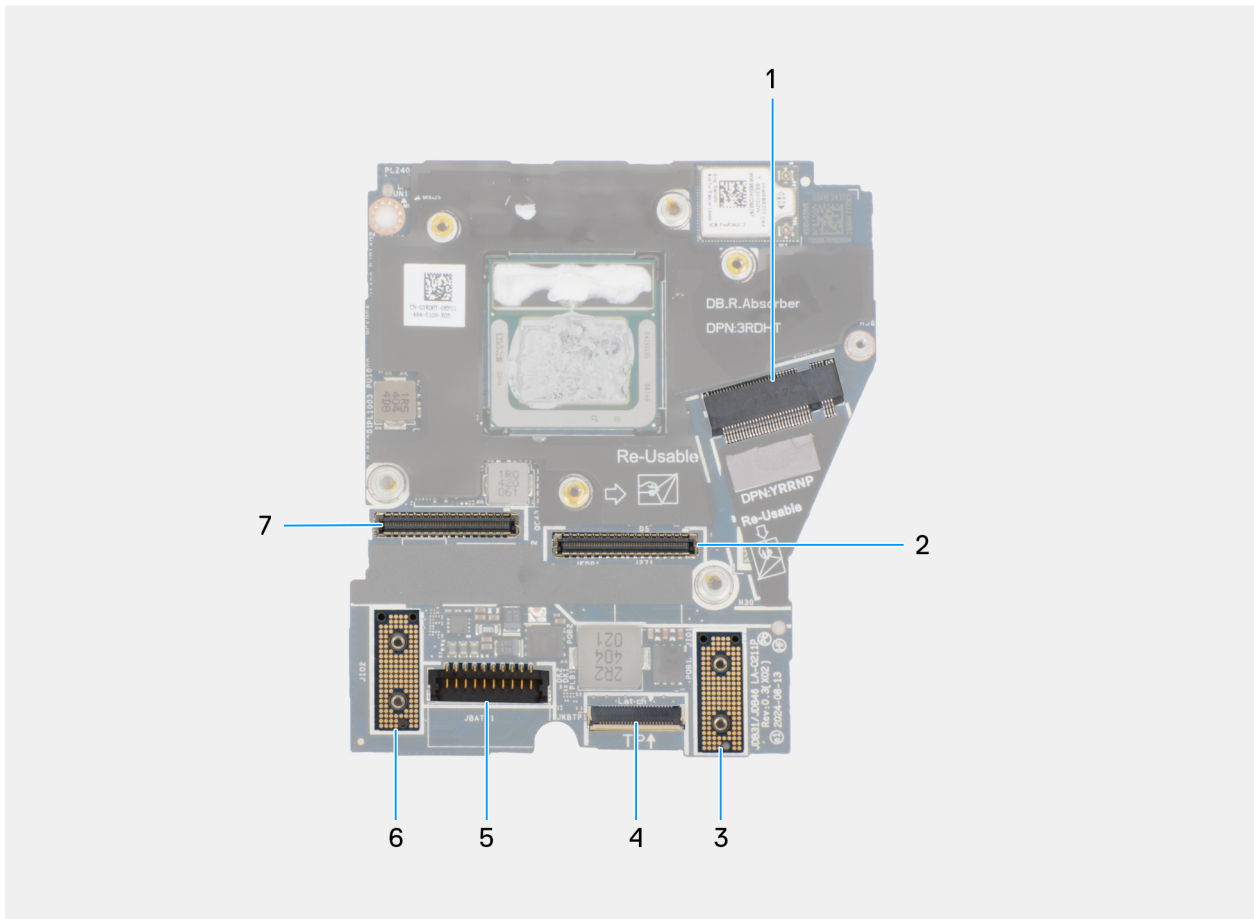

Figure 61. System board callout

1. SSD slot connector
2. Display-cable connector
3. Left I/O-board connector
4. Touchpad-cable connector
5. Battery-cable connector
6. Right I/O-board connector
7. IR-camera cable connector

The following images indicate the location of the system board and provide a visual representation of the removal procedure.

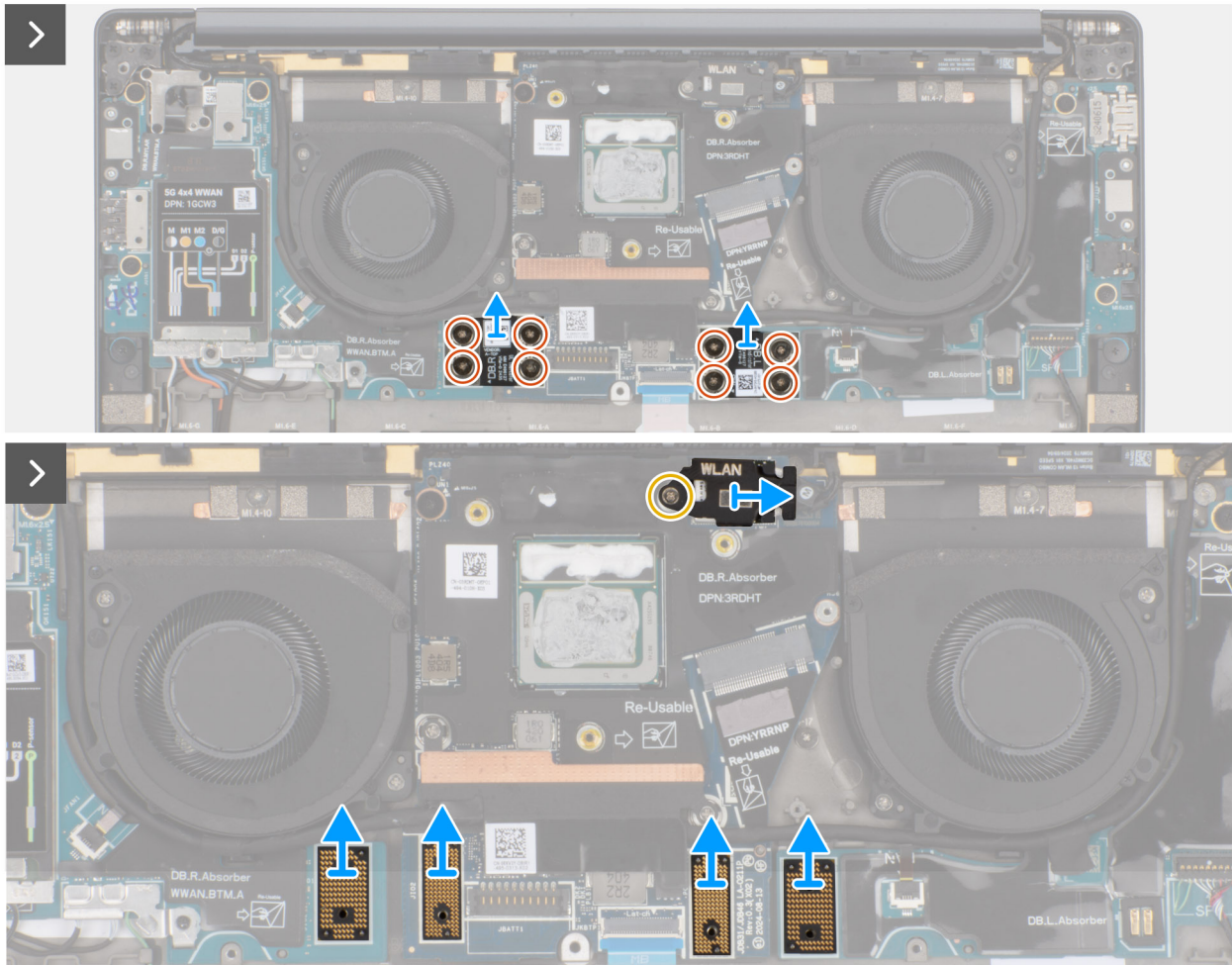
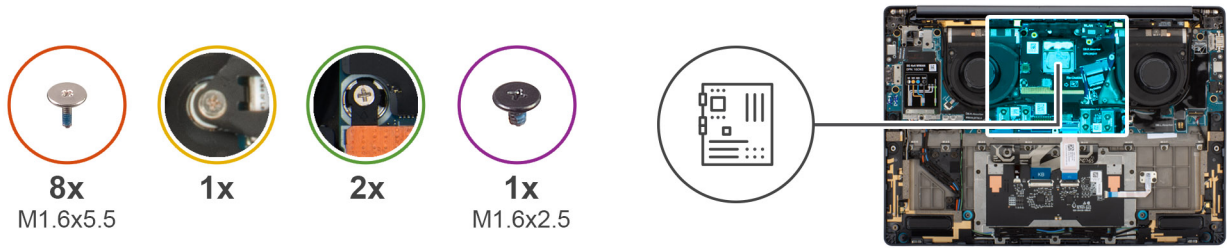

Figure 62. Removing the system board

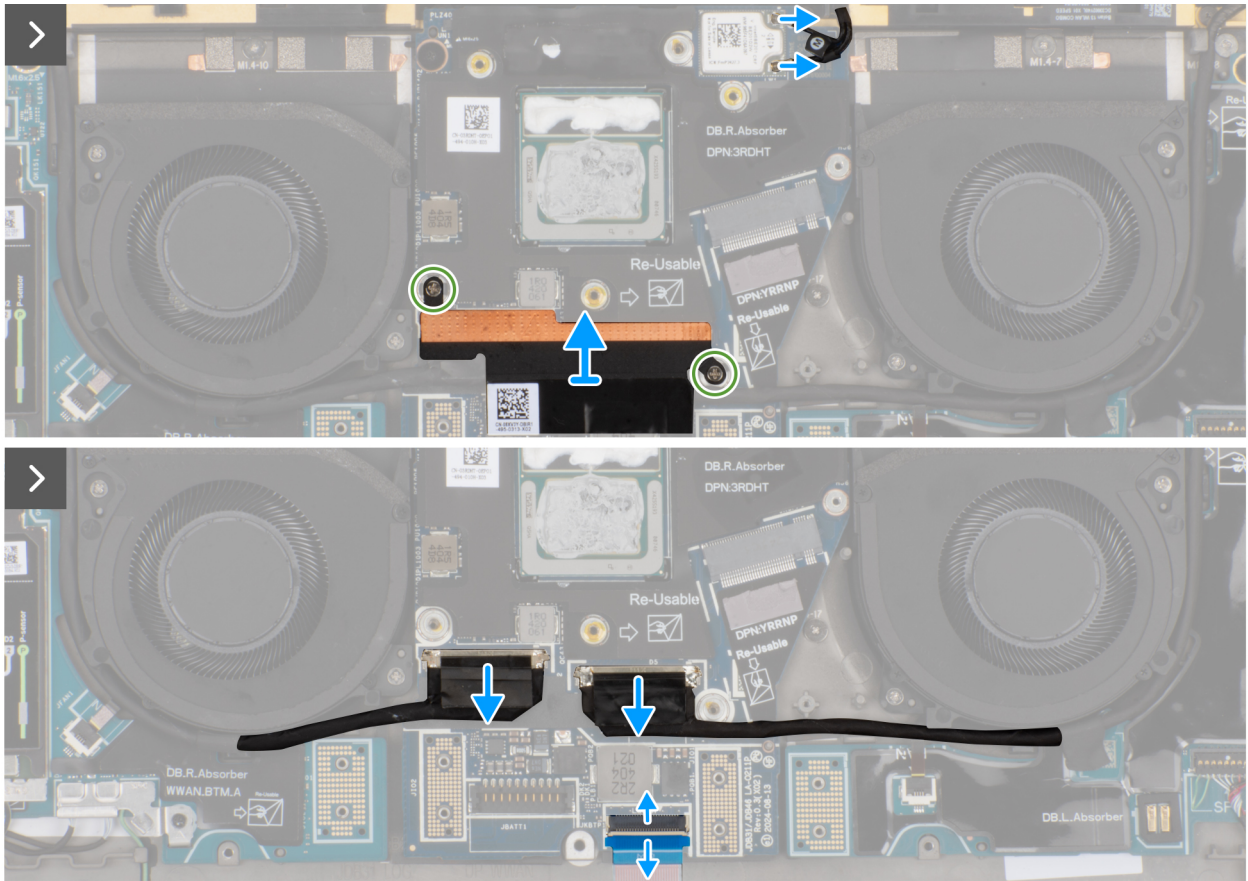

Figure 63. Removing the system board

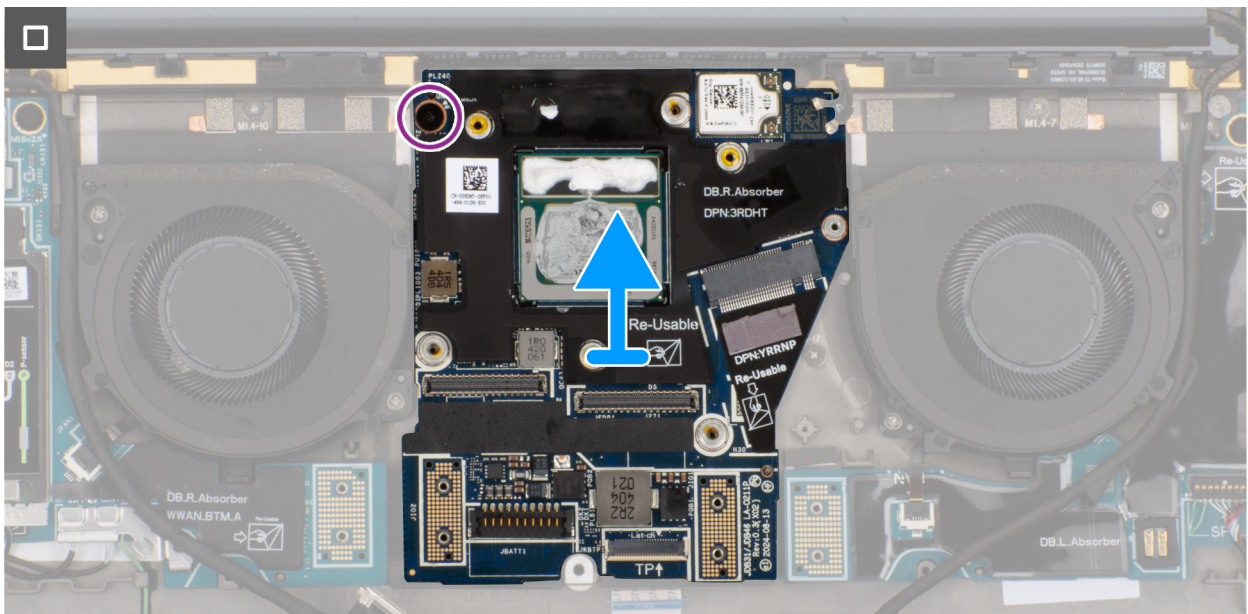

Figure 64. Removing the system board

Steps

1. Remove the eight screws (M1.6x5.5) that secure the right I/O-board and left I/O-board cable connectors to the system board.

NOTE: When reinstalling the right I/O-board cable connectors, align the connector so that the side labeled 'MB' is connected to the system board, and the side labeled **DB-R** is connected to the right I/O-board.

NOTE: When reinstalling the left I/O-board cable connectors, align the connector so that the side labeled 'MB' is connected to the system board, and the side labeled **DB-L** is connected to the left I/O-board.

2. Remove the right I/O-board and left I/O-board cable connectors from the system board.
3. Remove the interposer boards from the right I/O-board, left I/O-board, and system board.

CAUTION: Technicians must remove the interposer board immediately after removing the I/O board cable connectors to prevent the board from falling out of the system during subsequent removal procedures.

NOTE: The pins on the interposer board are fragile. Avoid contact with the pins on the board, instead handle the board by lifting and holding from the edges or the sides.

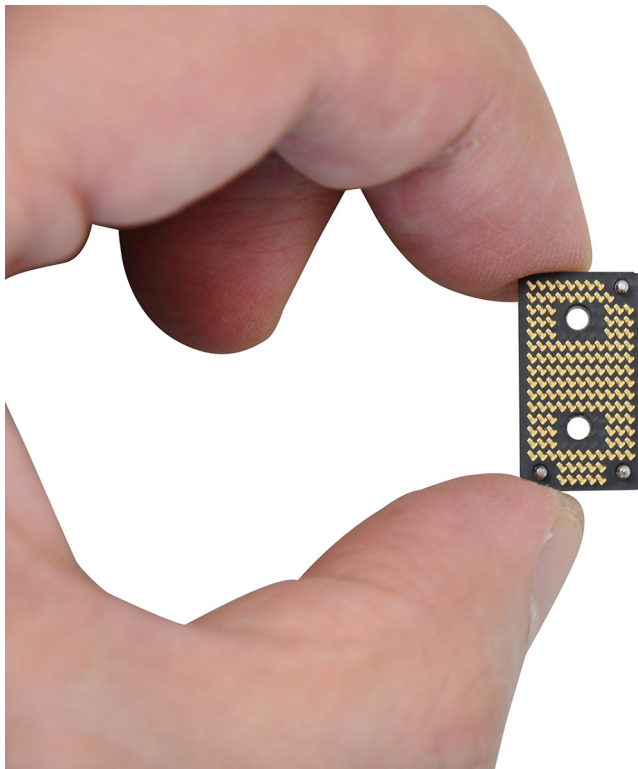

Figure 65. Interposed board handling

4. Loosen the single captive screw that secures the WLAN module bracket on the system board.
5. Lift and remove the WLAN module bracket from the system board.
6. Disconnect the WLAN antennas from the WLAN module.
7. Loosen the two captive screws that secure the display-cable bracket on the system board.
8. Remove the display-cable bracket from the system.
9. Disconnect the display cable, camera cable, and touchpad cable from the system board.

NOTE: To disconnect the touchpad cable, make sure to unlock the latch.

10. Remove the screw (M1.6x2.5) that secures the system board in place.
11. Lift and remove the system board from the computer.

NOTE: If replacing the system board, peel off the SSD thermal pad sticker and mylar and then transfer it over to the new system board.

Installing the system board

CAUTION: The information in this section is intended for authorized service technicians only.

Prerequisites

If you are replacing a component, remove the existing component before performing the installation procedure.

About this task

The following image indicates the connectors on your system board.

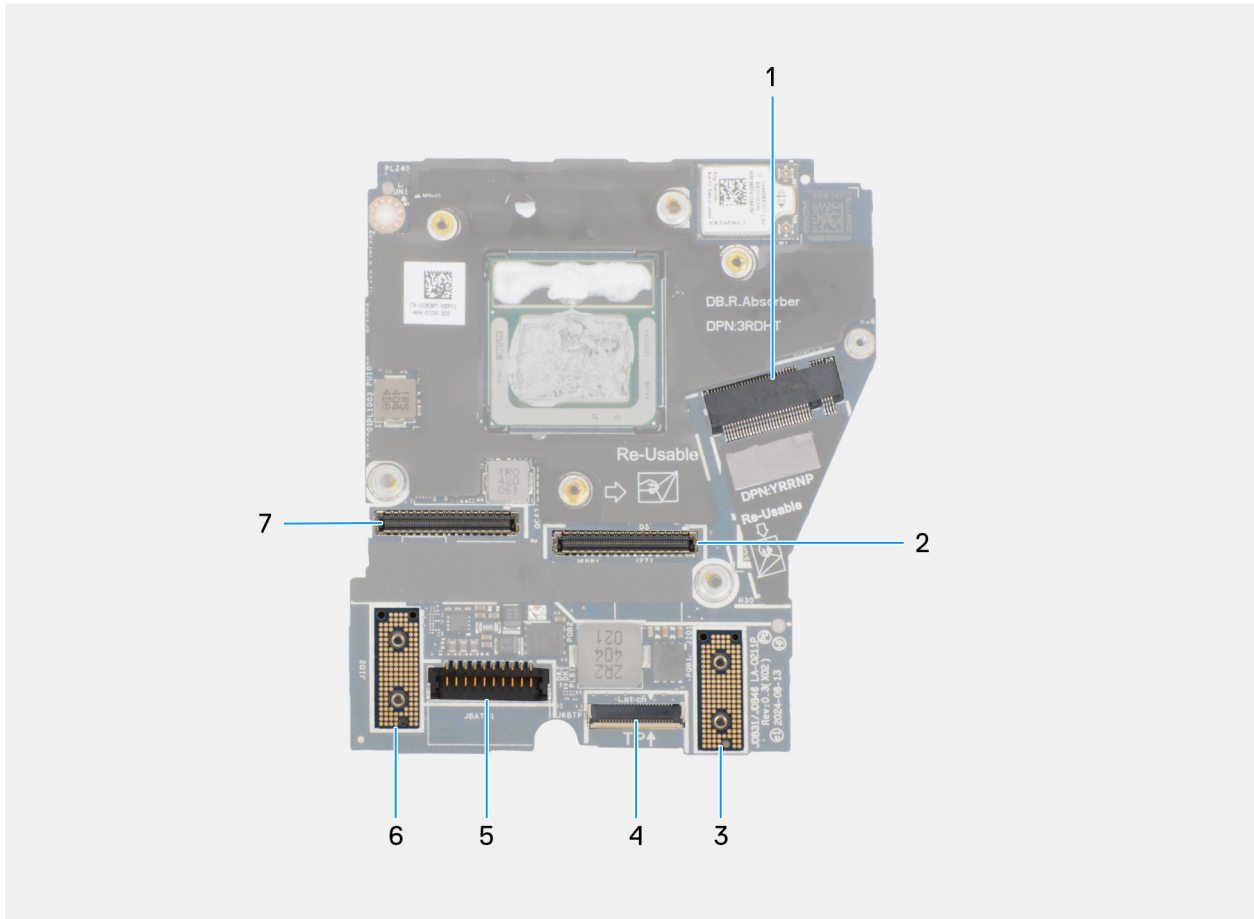

Figure 66. System board callout

1. SSD slot connector
2. Display-cable connector
3. Left I/O-board connector
4. Touchpad-cable connector
5. Battery-cable connector
6. Right I/O-board connector
7. IR-camera cable connector

The following images indicate the location of the system board and provide a visual representation of the installation procedure.

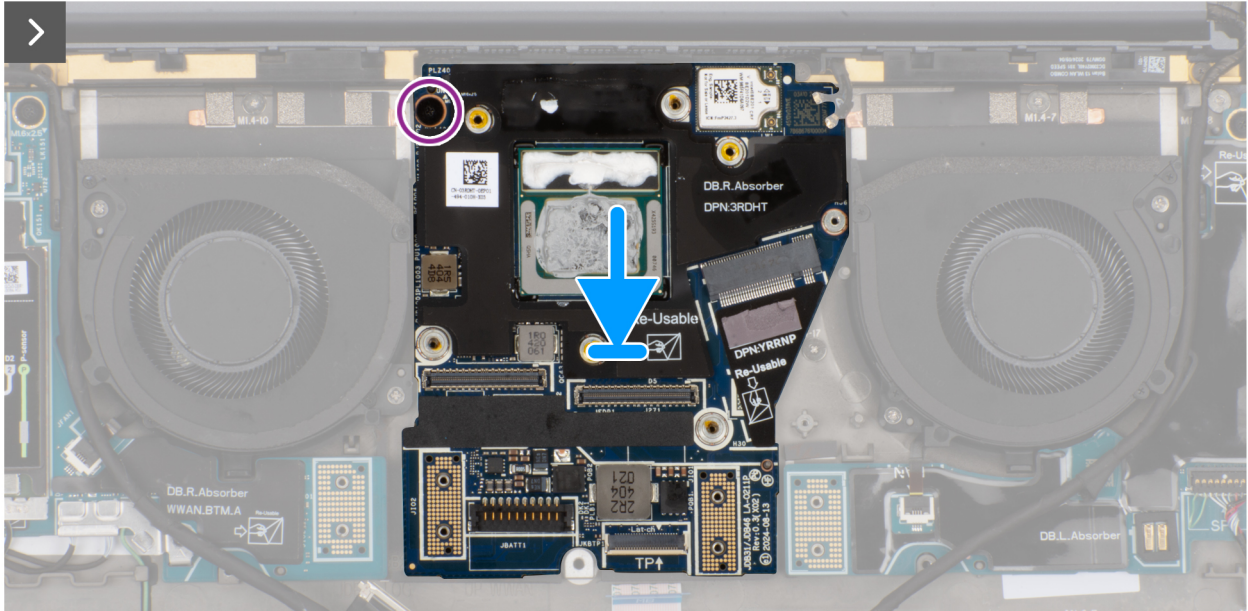
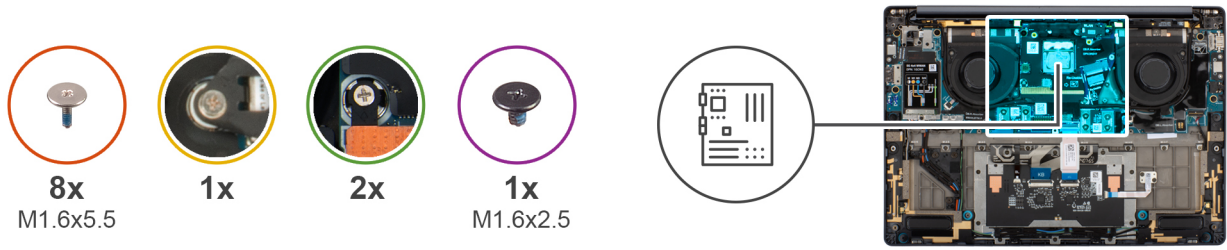

Figure 67. Installing the system board

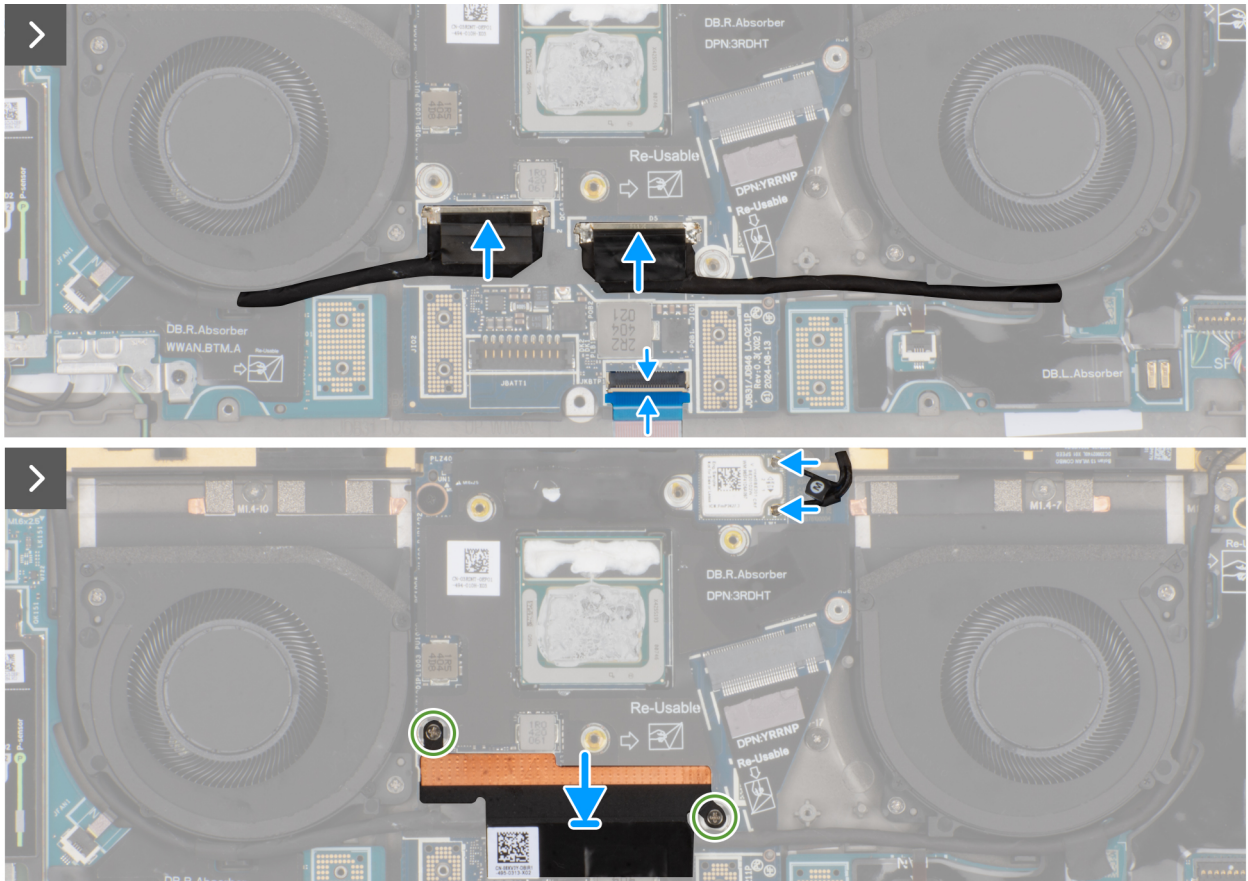

Figure 68. Installing the system board

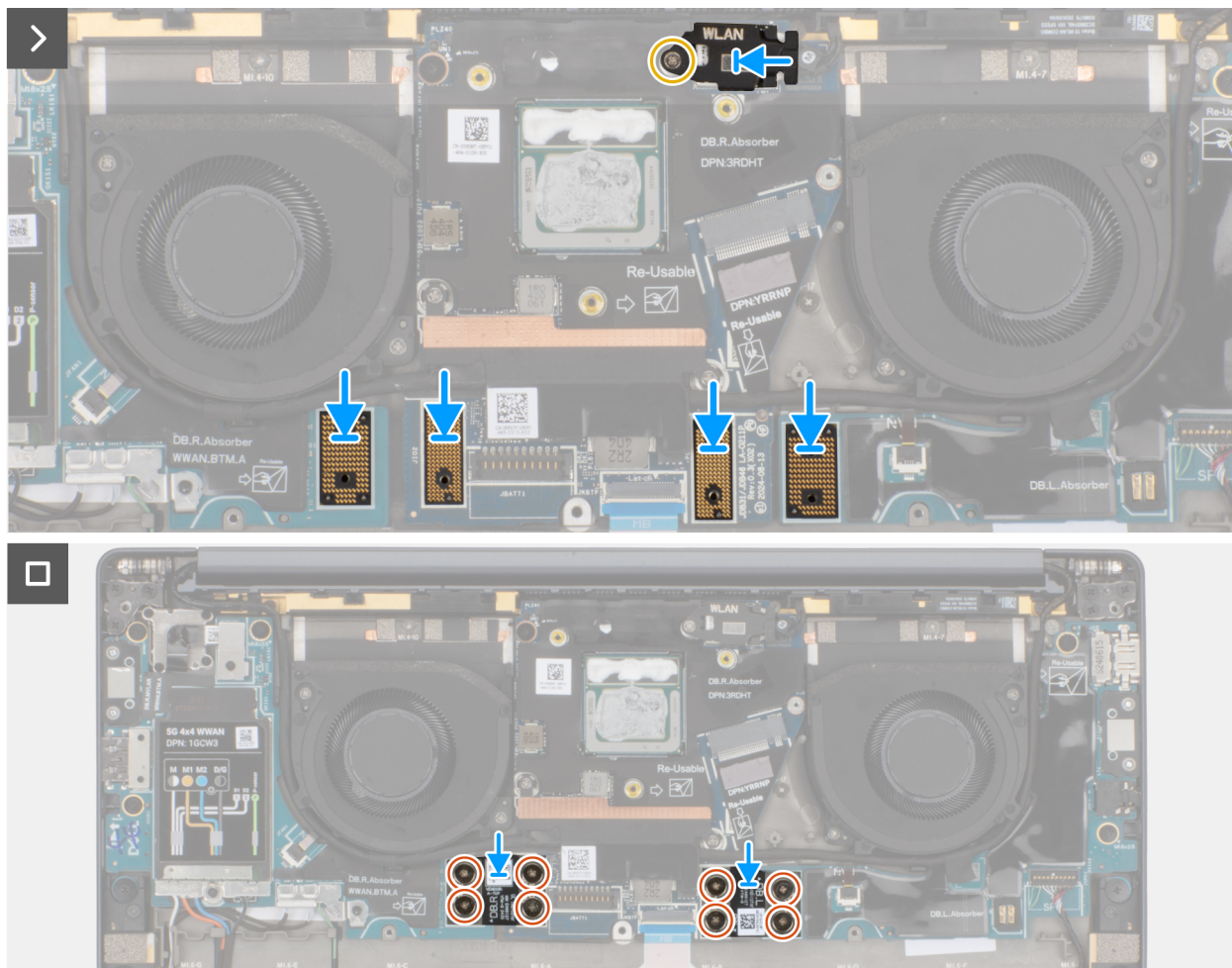

Figure 69. Installing the system board

Steps

1. Place the system board into the respective slot on the palm-rest and keyboard assembly.
2. Replace the screw (M1.6x2.5) that secures the system board to the palm-rest and keyboard assembly.
3. Connect the display cable, camera cable, and touchpad cable to the system board.
4. Align and place the display-cable bracket on the system board.
5. Tighten the two captive screws that secure the display-cable bracket on the system board.
6. Connect the WLAN antennas to the WLAN module.
7. Align and replace the WLAN-module bracket on the system board.
8. Tighten the single captive screw that secures the WLAN-module bracket on the system board.
9. Replace the interposer boards on the right I/O-board, left I/O-board, and system board.

NOTE: The pins on the interposer board are fragile. Avoid contact with the pins on the board, instead handle the board by lifting and holding from the edges or the sides.

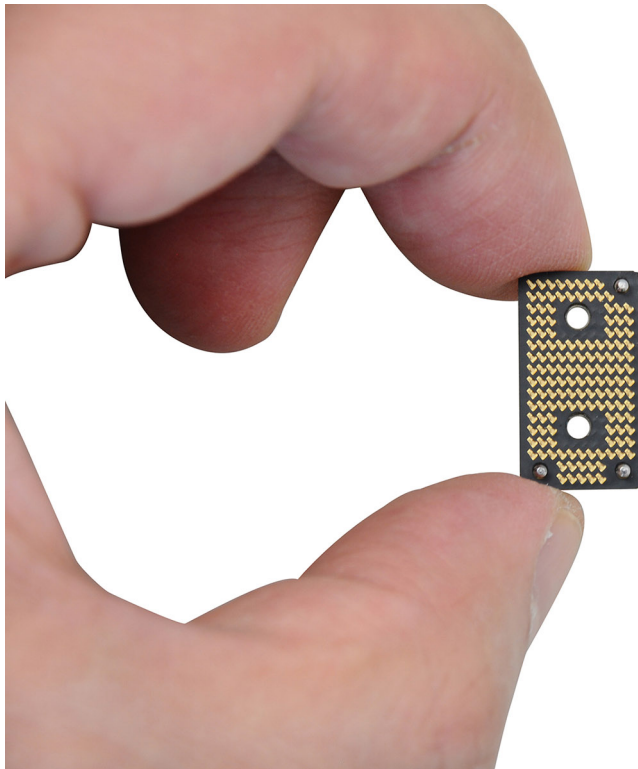

Figure 70. Holding the interpose board

10. Replace the eight screws (M1.6x5.5) that secure the right I/O-board and left I/O-board cable connectors on the system board.

NOTE: You must apply the XPG gel to the DRAMs of the CPU package.

Next steps

1. Install the [heat sink](#).
2. Install the [battery](#).
3. Install the [M.2 2230 solid state drive](#).
4. Install the [base cover](#).
5. Follow the procedure in [After working inside your computer](#).

Keyboard

Removing the keyboard assembly

CAUTION: The information in this section is intended for authorized service technicians only.

Prerequisites

1. Follow the procedure in [Before working inside your computer](#).
2. Remove the [base cover](#).
3. Remove the [M.2 2230 solid state drive](#).
4. Remove the [nano-SIM card tray](#) and [nano-SIM card](#) (for computers shipped with WWAN card).
5. Remove the [WWAN card](#) (for the computer shipped with WWAN card).
6. Remove the [speaker](#) (for the computer shipped with WWAN card).
7. Remove the [speaker](#) (for the computer shipped without WWAN card).
8. Remove the [right I/O-board](#) (for the computer shipped without WWAN card).

9. Remove the [right I/O-board](#) (for the computer shipped with WWAN card).
10. Remove the [left I/O-board](#).
11. Remove the [left fan](#).
12. Remove the [right fan](#).
13. Remove the [power button](#).
14. Remove the [battery](#).
15. Remove the [heat sink](#).
16. Remove the [system board](#).

NOTE: When removing the system board to replace or access other parts, the system board can be removed and installed with the heat sink attached to simplify the procedure and preserve the thermal bond between the system board and heat sink.

About this task

The following images indicate the location of the keyboard and provide a visual representation of the removal procedure.

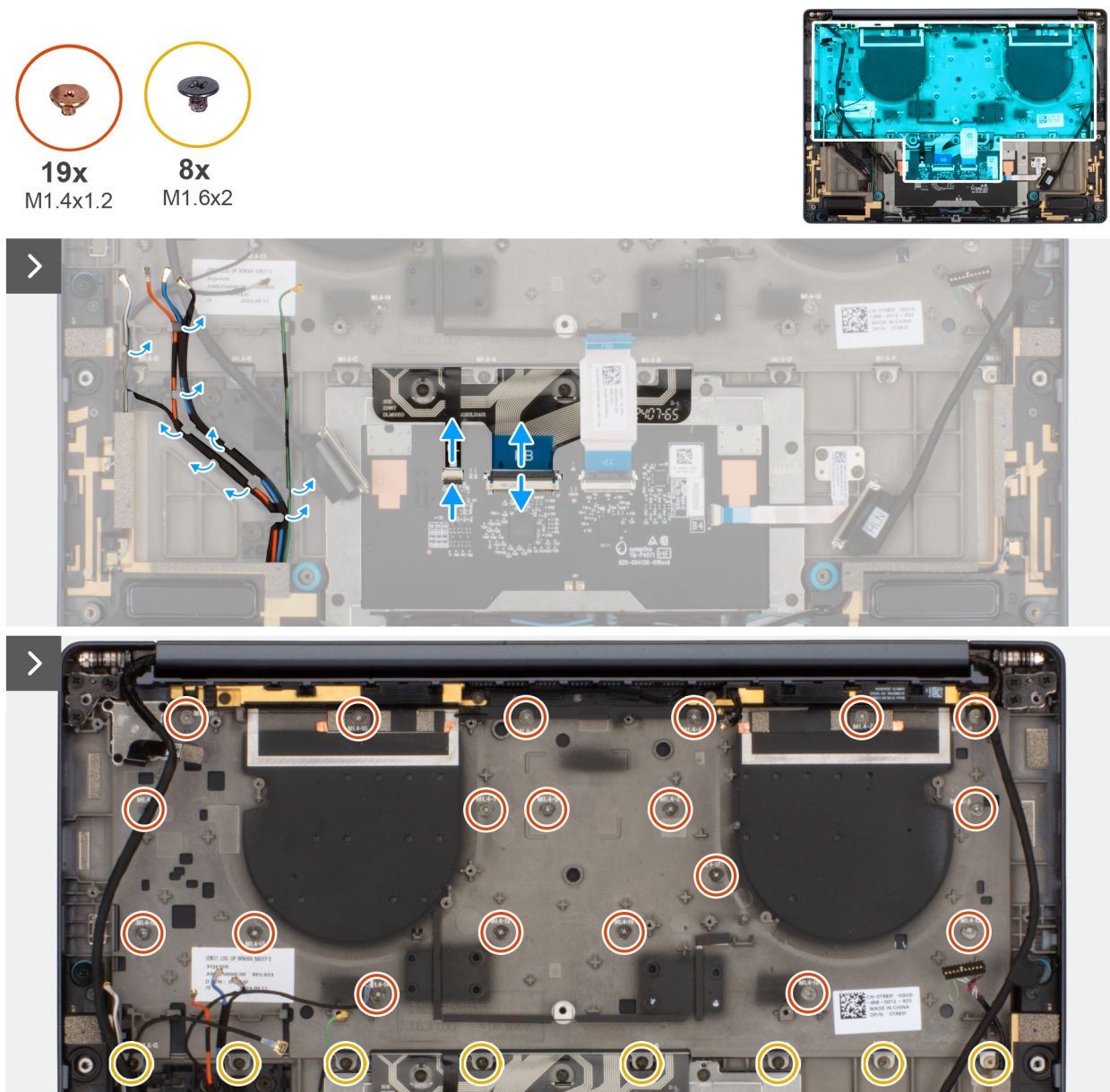

Figure 71. Removing the keyboard assembly



Figure 72. Removing the keyboard assembly

Steps

1. Unroute the WWAN antenna cable from the keyboard bracket.
2. Disconnect the keyboard cable and keyboard-backlight cable from the touchpad module.
3. Remove the nineteen screws (M1.4x1.2) and eight screws (M1.6x2) that secure the keyboard assembly to the computer.
4. Lift the keyboard to remove it from the computer.

Installing the keyboard assembly

CAUTION: The information in this section is intended for authorized service technicians only.

Prerequisites

If you are replacing a component, remove the existing component before performing the installation procedure.

About this task

The following images indicate the location of the keyboard and provide a visual representation of the installation procedure.

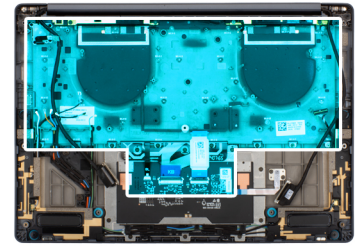
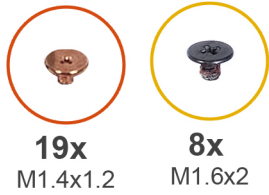

Figure 73. Installing the keyboard assembly

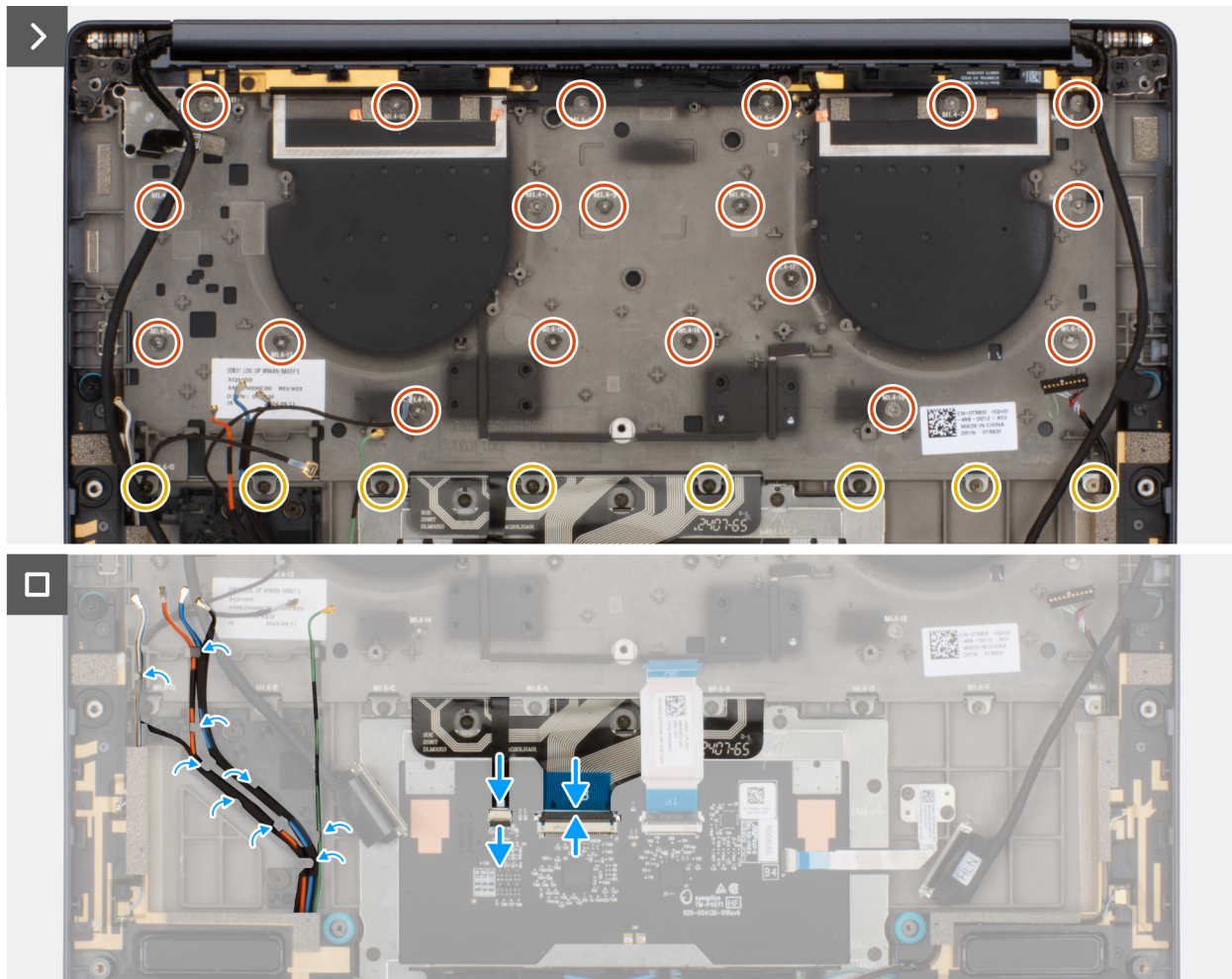

Figure 74. Installing the keyboard assembly

Steps

1. Align the screw holes on the keyboard to the screw holes on the keyboard support plate and place the keyboard on the keyboard support plate.
2. Replace the nineteen screws (M1.4x1.2) and eight screws (M1.6x2) that secure the keyboard assembly to the system.
3. Connect the keyboard cable and keyboard-backlight cable from the touchpad module.

Next steps

1. Install the [system board](#).
2. Install the [heat sink](#).
3. Install the [battery](#).
4. Install the [power button](#).
5. Install the [left fan](#).
6. Install the [right fan](#).
7. Install the [left I/O-board](#).
8. Install the [right I/O-board](#) (for the computer shipped with WWAN card).
9. Install the [right I/O-board](#) (for the computer shipped without WWAN card).
10. Install the [speaker](#) (for the computer shipped with WWAN card).
11. Install the [speaker](#) (for the computer shipped without WWAN card).
12. Install the [WWAN card](#) (for the computer shipped with WWAN card).
13. Install the [nano-SIM card](#) and [nano-SIM card tray](#) (for the computer shipped with WWAN card).
14. Install the [M.2 2230 solid state drive](#).
15. Install the [base cover](#).
16. Follow the procedure in [After working inside your computer](#).

Palm-rest assembly

Removing the palm-rest assembly

 **CAUTION:** The information in this section is intended for authorized service technicians only.

Prerequisites

1. Follow the procedure in [Before working inside your computer](#).
2. Remove the [base cover](#).
3. Remove the [M.2 2230 solid-state drive](#).
4. Remove the [nano-SIM card tray](#) and [nano-SIM card](#) (for the computer shipped with WWAN card).
5. Remove the [WWAN card](#) (for the computer shipped with WWAN card).
6. Remove the [speaker](#) (for the computer shipped with WWAN card).
7. Remove the [speaker](#) (for the computer shipped without WWAN card).
8. Remove the [right I/O-board](#) (for the computer shipped without WWAN card).
9. Remove the [right I/O-board](#) (for the computer shipped with WWAN card).
10. Remove the [left I/O-board](#).
11. Remove the [power button](#).
12. Remove the [battery](#).
13. Remove the [heat sink](#).
14. Remove the [system board](#).
15. Remove the [display assembly](#).
16. Remove the [keyboard](#).

 **NOTE:** When removing the system board to replace or access other parts, the system board can be removed and installed with the heat sink attached to simplify the procedure and preserve the thermal bond between the system board and heat sink.

About this task

 **NOTE:** The palm-rest assembly cannot be further disassembled once all the pre-removal parts procedures are completed. If the keyboard is malfunctioning and is required to be replaced, replace the entire palm-rest assembly.

The image below shows the palm-rest assembly after the pre-removal parts procedures have been performed for any palm-rest assembly replacement.

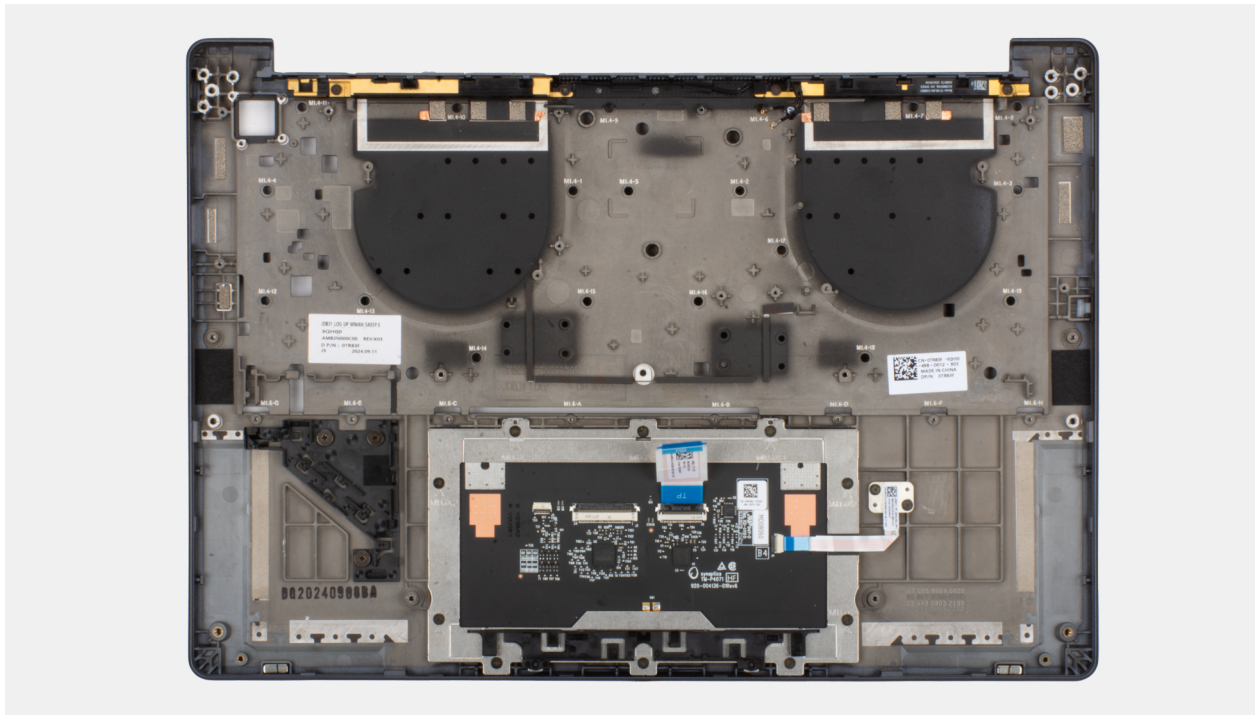

Figure 75. Palm-rest

Steps

After performing the pre-requisites, you are left with the palm-rest assembly.

Installing the palm-rest assembly

CAUTION: The information in this section is intended for authorized service technicians only.

Prerequisites

If you are replacing a component, remove the existing component before performing the installation procedure.

About this task

The following image indicates the location of the palm-rest assembly and provides a visual representation of the installation procedure.

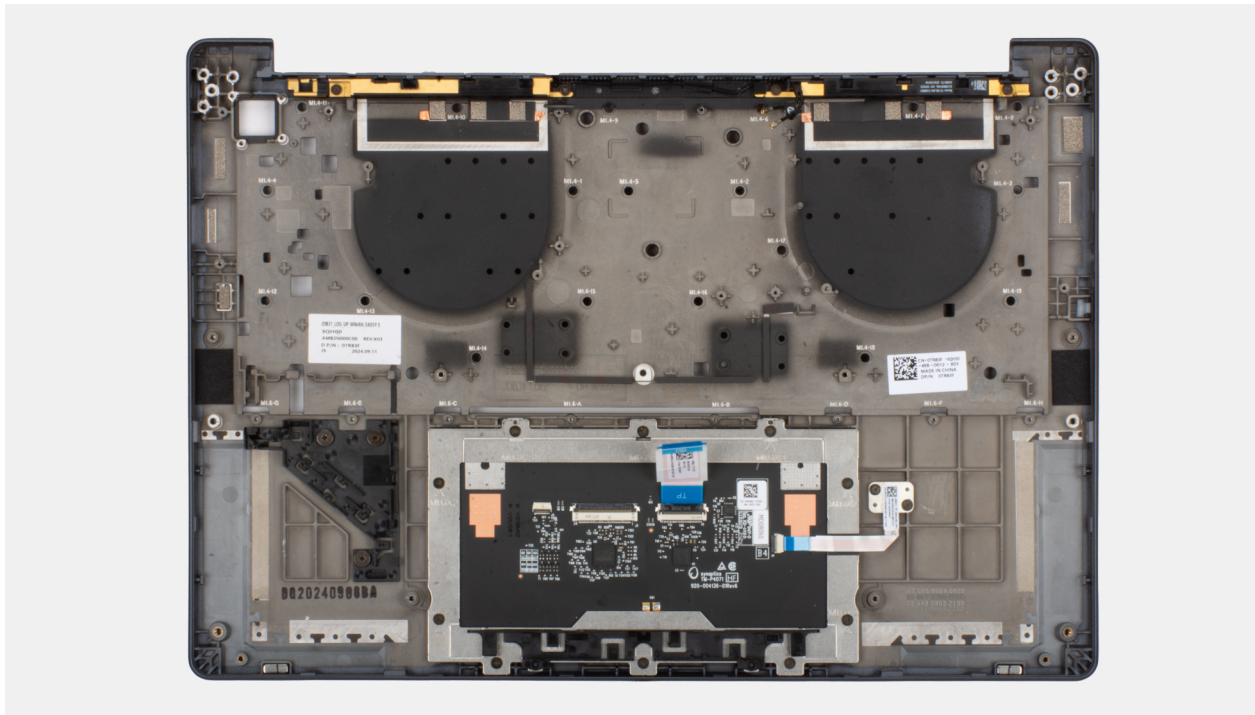

Figure 76. Palm-rest

Steps

Place the palm-rest assembly on a flat surface and perform the post-requisites to install the palm-rest assembly.

Next steps

1. Install the [keyboard](#).
2. Install the [display assembly](#).
3. Install the [system board](#).
4. Install the [heat sink](#).
5. Install the [battery](#).
6. Install the [power button](#).
7. Install the [left I/O-board](#).
8. Install the [right I/O-board](#) (for the computer shipped with WWAN card).
9. Install the [right I/O-board](#) (for the computer shipped without WWAN card).
10. Install the [speaker](#) (for the computer shipped with WWAN card).
11. Install the [speaker](#) (for the computer shipped without WWAN card).
12. Install the [WWAN card](#) (for the computer shipped with WWAN card).
13. Install the [nano-SIM card](#) and [nano-SIM card tray](#) (for the computer shipped with WWAN card).
14. Install the [M.2 2230 solid-state drive](#).
15. Install the [base cover](#).
16. Follow the procedure in [After working inside your computer](#).

Software

This chapter details the supported operating systems along with instructions on how to install the drivers.

Operating system

Your Dell Pro 13 Premium PA13250 supports the following operating systems:

- Windows 11 24H2
- Windows 11 23H2
- Windows 10 22H2
- Ubuntu Linux 24.04

NOTE: Windows 10 22H2 is only for custom configured computers downgraded by end users from Windows 11. Windows 10 22H2 downgraded installations are supported by customer internal IT and is subjected to the Microsoft Windows 10 End of Support plan.

Drivers and downloads

When troubleshooting, downloading, or installing drivers, it is recommended that you read the Dell Knowledge Base article Drivers and Downloads FAQs [000123347](#).

BIOS Setup

NOTE: Depending on the computer and the installed devices, the options that are listed in this section may or may not be displayed.

CAUTION: Certain changes can make your computer work incorrectly. Before you change the settings in BIOS Setup, it is recommended that you note down the original settings for future reference.

Use BIOS Setup for the following purposes:

- Get information about the hardware installed in your computer, such as the amount of RAM and the capacity of the storage device.
- Change the system configuration information.
- Set or change a user-selectable option, such as the user password, type of storage device installed, and enable or disable base devices.

Entering BIOS Setup program

Turn on or restart your computer and press F2 immediately.

Navigation keys

NOTE: For most of the BIOS Setup options, changes that you make are recorded but do not take effect until you restart the computer.

Table 32. Navigation keys

Keys	Navigation
Up arrow	Moves to the previous field.
Down arrow	Moves to the next field.
Enter	Selects a value in the selected field (if applicable) or follows the link in the field.
Spacebar	Expands or collapses a drop-down list, if applicable.
Tab	Moves to the next focus area.
Esc	Moves to the previous page until you view the main screen. Pressing Esc in the main screen displays a message that prompts you to save any unsaved changes and restart the computer.

F12 One Time Boot menu

To enter the One Time Boot menu, turn on or restart your computer, and then press F12 immediately.

NOTE: If you are unable to enter the One Time Boot menu, repeat the above action.

The One Time Boot menu displays the devices that you can boot from and also display the options to start diagnostics. The boot menu options are:

- Removable Drive (if available)
- STXXXX Drive (if available)

NOTE: XXX denotes the SATA drive number.

- Optical Drive (if available)
- SATA Hard Drive (if available)
- Diagnostics

The One Time Boot menu screen also displays the option to access BIOS Setup.

View Advanced Setup options

About this task

Some BIOS Setup options are only visible by enabling **Advanced Setup** mode, which is disabled by default.

NOTE: BIOS Setup options, including **Advanced Setup** options, are described in [BIOS setup options](#).

To enable Advanced Setup:

Steps

1. Enter BIOS Setup.
The Overview menu appears.
2. Click the **Advanced Setup** option to move it to the **ON** mode.
Advanced BIOS Setup options are displayed.

View Service options

About this task

Service options are hidden by default and only visible by entering a hotkey command.

NOTE: Service options are described in [BIOS Setup options](#).

To view Service options:

Steps

1. Enter BIOS Setup.
The Overview menu appears.
2. Enter the hotkey combination **Ctrl + Alt + s** to view the **Service** options.
Service options are displayed.

System Setup options

NOTE: For most of the System Setup options, changes that you make are recorded but do not take effect until you restart the computer.

NOTE: Depending on your computer and its installed devices, the items that are listed in this section may differ.

Table 33. System Setup options—Overview menu

Overview	
Dell Pro 13 Premium PA13250	
BIOS Version	Displays the BIOS version number.
Service Tag	Displays the Service Tag of the computer.
Asset Tag	Displays the Asset Tag of the computer.

Table 33. System Setup options—Overview menu (continued)







Overview	
Manufacture Date	Displays the manufacture date of the computer.
Ownership Date	Displays the ownership date of the computer.
Express Service Code	Displays the Express Service Code of the computer.
Ownership Tag	Displays the Ownership Tag of the computer.
Signed Firmware Update	<p>Displays whether the Signed Firmware Update is enabled on your computer. By default, the Signed Firmware Update option is enabled.</p> <p> NOTE: To view this option, enable Service options as described in View Service options.</p>
BATTERY Information	
Primary	Displays the primary battery of the computer.
Battery Level	Displays the battery level of the computer.
Battery State	Displays the battery state of the computer.
Health	Displays the battery health of the computer.
AC Adapter	Displays whether an AC adapter is connected. If connected, displays the type of AC adapter that is connected.
Battery Life Type	Displays the battery life type.
PROCESSOR Information	
Processor Type	Displays the processor type.
Maximum Clock Speed	Displays the maximum processor clock speed.
Minimum Clock Speed	<p>Displays the minimum processor clock speed.</p> <p> NOTE: To view this option, enable Service options as described in View Service options.</p>
Current Clock Speed	<p>Displays the current processor clock speed.</p> <p> NOTE: To view this option, enable Service options as described in View Service options.</p>
Core Count	Displays the number of cores on the processor.
Processor ID	<p>Displays the processor identification code.</p> <p> NOTE: To view this option, enable Advanced Setup mode as described in View Advanced Setup options.</p>
Processor L2 Cache	Displays the processor L2 cache size.
Processor L3 Cache	Displays the processor L3 cache size.
Microcode Version	<p>Displays the microcode version.</p> <p> NOTE: To view this option, enable Advanced Setup mode as described in View Advanced Setup options.</p>
Intel Hyper-Threading Capable	<p>Displays whether the processor is Hyper-Threading (HT) capable.</p> <p> NOTE: To view this option, enable Advanced Setup mode as described in View Advanced Setup options.</p>
Intel vPro Technology	Displays whether the processor is Intel vPro Technology capable.
MEMORY Information	
Memory Installed	Displays the total memory installed on the computer.

Table 33. System Setup options—Overview menu (continued)

Overview	
Memory Available	Displays the total memory available on the computer. i NOTE: To view this option, enable Advanced Setup mode as described in View Advanced Setup options .
Memory Speed	Displays the memory speed.
Memory Channel Mode	Displays single or dual channel mode. i NOTE: To view this option, enable Service options as described in View Service options .
Memory Technology	Displays the technology that is used for the memory. i NOTE: To view this option, enable Advanced Setup mode as described in View Advanced Setup options .
DEVICES Information	
Panel Type	Displays the type of display panel available on the computer.
Panel Revision	Displays the Panel Revision of the computer.
Video Controller	Displays the type of video controller available on the computer.
Video Memory	Displays the video memory information of the computer.
Wi-Fi Device	Displays the wireless device information of the computer.
Native Resolution	Displays the native resolution of the computer.
Video BIOS Version	Displays the video BIOS version of the computer. i NOTE: To view this option, enable Advanced Setup mode as described in View Advanced Setup options .
Audio Controller	Displays the audio controller information of the computer.
Bluetooth Device	Displays the Bluetooth device information of the computer.
Pass Through MAC Address	Displays the MAC address of the video pass-through.
Cellular Device	Displays the Cellular Device that is used in the computer.

Table 34. System Setup options—Boot Configuration menu

Boot Configuration	
Boot Sequence	
Enable PXE Boot Priority	Enables or disables the PXE Boot Priority. By default, the PXE Boot Priority option is disabled.
Secure Boot	
Enable Secure Boot	Secure Boot is a method of guaranteeing the integrity of the boot path by performing additional validation of the operating system and PCI add-in cards. The computer stops booting to the operating system when a component is not authenticated during the boot process. Secure Boot can be enabled in BIOS setup or using management interfaces like Dell Command Configure, but can only be disabled from BIOS setup. Enables the computer to boot using only validated boot software. By default, this Enable Secure Boot option is disabled. For additional security, Dell Technologies recommends keeping the Secure Boot option enabled to ensure that the UEFI firmware validates the operating system during the boot process. i NOTE: To enable Secure Boot, the computer must be in UEFI boot mode and the Enable Legacy Option ROMs option must be turned off.

Table 34. System Setup options—Boot Configuration menu (continued)



Boot Configuration	
Enable Microsoft UEFI CA	<p>When disabled, the UEFI CA is removed from the BIOS UEFI Secure Boot database.</p> <p> CAUTION: If you disable Microsoft UEFI CA, the computer may not boot, computer graphics may not function properly, and the computer could become unrecoverable.</p> <p>By default, the Enable Microsoft UEFI CA option is enabled.</p> <p>For additional security, Dell Technologies recommends keeping the Enable Microsoft UEFI CA option enabled to ensure the broadest compatibility with devices and operating systems.</p>
Secure Boot Mode	<p>Enables or disables the Secure Boot operation mode.</p> <p>By default, the Deployed Mode is selected. Deployed Mode should be selected for normal operation of Secure Boot.</p>
Expert Key Management	
Enable Custom Mode	<p>Enables or disables the keys in the PK, KEK, db, and dbx security key databases to be modified.</p> <p>By default, the Enable Custom Mode option is disabled.</p> <p> NOTE: To view this option, enable Advanced Setup mode as described in View Advanced Setup options.</p>
Custom Mode Key Management	<p>Selects the custom values for expert key management.</p> <p>By default, the PK option is selected.</p> <p> NOTE: To view this option, enable Advanced Setup mode as described in View Advanced Setup options.</p>

Table 35. System Setup options—Integrated Devices menu



Integrated Devices	
Date/Time	
Date	Sets the computer date in MM/DD/YYYY format. Changes to the date format take effect immediately.
Time	Sets the computer time in HH/MM/SS 24-hour format. You can select between a 12-hour or 24-hour clock. Changes to the time format take effect immediately.
Camera	
Enable Camera	<p>Enables the camera.</p> <p>By default, the Enable Camera option is enabled.</p> <p> NOTE: Depending on the configuration ordered, the camera setup option may not be available.</p>
Audio	
Enable Audio	<p>Enables all integrated audio controller.</p> <p>By default, all the options are enabled.</p>
Enable Microphone	<p>Enables the microphone.</p> <p>By default, the Enable Microphone option is enabled.</p> <p> NOTE: Depending on the configuration ordered, the microphone setup option may not be available.</p>
Enable Internal Speaker	Enables the internal speaker.

Table 35. System Setup options—Integrated Devices menu (continued)

Integrated Devices	
	By default, the Enable Internal Speaker option is enabled.
USB/Thunderbolt Configuration	
Enable USB Boot Support	Enables booting from USB mass storage devices that are connected to external USB ports. By default, the Enable USB Boot Support option is enabled.
Enable External USB Ports	Enables the external USB ports. By default, the Enable External USB Ports option is enabled. i NOTE: To view this option, enable Advanced Setup mode as described in View Advanced Setup options .
Enable Thunderbolt Technology Support	
Enable Thunderbolt Technology Support	Enables the associated ports and adapters for Thunderbolt Technology support. By default, the Enable Thunderbolt Technology Support option is enabled.
Enable Thunderbolt Boot Support	
Enable Thunderbolt Boot Support	Enables the Thunderbolt adapter-peripheral device and USB devices that are connected to the Thunderbolt adapter to be used during BIOS Preboot. By default, the Enable Thunderbolt Boot Support option is disabled. i NOTE: To view this option, enable Advanced Setup mode as described in View Advanced Setup options .
Disable USB4 PCIE Tunneling	
Disable USB4 PCIE Tunneling	Disables the USB4 PCIE Tunneling option. By default, the Disable USB4 PCIE Tunneling option is disabled. i NOTE: To view this option, enable Advanced Setup mode as described in View Advanced Setup options .
Video/Power only on Type-C Ports	
Video/Power only on Type-C Ports	Enables or disables the Type-C port functionality to video or only power. By default, the Video/Power only on Type-C Ports option is disabled. i NOTE: To view this option, enable Advanced Setup mode as described in View Advanced Setup options .
Type-C Dock	
Type-C Dock Override	Enables or disables to use connected Type-C Dell Dock to provide data stream with external USB ports disabled. When Type-C Dock override is enabled, the Video/Audio/LAN submenu is activated. By default, the Type-C Dock Override option is enabled. i NOTE: To view this option, enable Advanced Setup mode as described in View Advanced Setup options .
Type-C Dock Audio	Enables or disables the usage of audio inputs and outputs from the connected Type-C Dell docking station. By default, the Type-C Dock Audio option is enabled. i NOTE: To view this option, enable Advanced Setup mode as described in View Advanced Setup options .

Table 35. System Setup options—Integrated Devices menu (continued)

Integrated Devices	
Type-C Dock LAN	<p>Enables or disables the usage of LAN on the external ports of the connected Type-C Dell docking station.</p> <p>By default, the Type-C Dock LAN option is enabled.</p> <p>i NOTE: To view this option, enable Advanced Setup mode as described in View Advanced Setup options.</p>
Miscellaneous Devices	
Enable Fingerprint Reader Device	<p>Enables or disables the Fingerprint Reader Device option.</p> <p>By default, the Enable Fingerprint Reader Device option is enabled.</p>
Unobtrusive Mode	<p>Enables or disables the unobtrusive mode. When enabled, all system LEDs, LCD panel backlight and audio devices of the computer are turned off.</p> <p>By default, the Unobtrusive Mode option is disabled.</p> <p>i NOTE: On computers with collaboration touchpad, the Collaboration Touchpad is disabled when the Unobtrusive Mode option is enabled.</p> <p>i NOTE: To view this option, enable Advanced Setup mode as described in View Advanced Setup options.</p>

Table 36. System Setup options—Storage menu

Storage	
SATA/NVMe Operation	
SATA/NVMe Operation	<p>Sets the operating mode of the integrated SATA hard drive controller.</p> <p>By default, the AHCI/NVME option is selected.</p> <p>i NOTE: To view this option, enable Advanced Setup mode as described in View Advanced Setup options.</p>
Storage Interface	
Storage Interface	Displays the information of various onboard drives.
Port Enablement	<p>Enables or disables the M.2 PCIe SSD option.</p> <p>By default, the M.2 PCIe SSD option is enabled.</p>
Smart Reporting	
Enable Smart Reporting	<p>Enables or disables the Smart reporting option.</p> <p>By default, the Smart Reporting option is disabled.</p> <p>i NOTE: To view this option, enable Advanced Setup mode as described in View Advanced Setup options.</p>
Drive Information	Displays the information of onboard drives.

Table 37. System Setup options—Display menu

Display	
Display Brightness	
Brightness on battery power	By default, the screen brightness is set to 50 when the computer is running on battery power. Set the screen brightness when the computer is running on battery power.

Table 37. System Setup options—Display menu (continued)

Display	
	<p>i NOTE: To view this option, enable Advanced Setup mode as described in View Advanced Setup options.</p>
Brightness on AC power	<p>By default, the screen brightness is set to 100 when the computer is running on AC power. Set the screen brightness when the computer is running on AC power.</p> <p>i NOTE: To view this option, enable Advanced Setup mode as described in View Advanced Setup options.</p>
Touchscreen	<p>Enables or disables the touch screen option.</p> <p>By default, the Touchscreen option is enabled.</p> <p>i NOTE: Only available on computers with touch screen displays.</p> <p>i NOTE: To view this option, enable Advanced Setup mode as described in View Advanced Setup options.</p>
Full Screen Logo	<p>Enables or disables the computer to display full screen logo, if the image matches screen resolution.</p> <p>By default, the Full Screen Logo option is disabled.</p> <p>i NOTE: To view this option, enable Advanced Setup mode as described in View Advanced Setup options.</p>

Table 38. System Setup options—Connection menu

Connection	
Wireless Device Enable	
WWAN/GPS	<p>Enables or disables the internal WWAN device.</p> <p>By default, the WWAN/GPS option is enabled.</p> <p>i NOTE: To view this option, enable Advanced Setup mode as described in View Advanced Setup options.</p>
WLAN	<p>Enables or disables the internal WLAN device.</p> <p>By default, the WLAN option is enabled.</p> <p>i NOTE: To view this option, enable Advanced Setup mode as described in View Advanced Setup options.</p>
Bluetooth	<p>Enables or disables the internal Bluetooth device.</p> <p>By default, the Bluetooth option is enabled.</p> <p>i NOTE: To view this option, enable Advanced Setup mode as described in View Advanced Setup options.</p>
Enable UEFI Network Stack	<p>Enables or disables the UEFI Network Stack and controls the onboard LAN Controller.</p> <p>By default, the Enable UEFI Network Stack option is enabled.</p> <p>i NOTE: To view this option, enable Advanced Setup mode as described in View Advanced Setup options.</p>
Wireless Radio Control	
Control WLAN Radio	<p>Enable to sense the connection of the computer to a wired network and then disables the selected WLAN radio. Upon disconnection from the wired network, the selected wireless radios are reenabled.</p> <p>By default, the Control WLAN Radio option is disabled.</p>

Table 38. System Setup options—Connection menu (continued)

Connection	
	<p>i NOTE: To view this option, enable Advanced Setup mode as described in View Advanced Setup options.</p>
Control WWAN Radio	<p>Enables to sense the connection of the computer to a wired network and then disables the selected WWAN radios.</p> <p>By default, the Control WWAN Radio option is disabled.</p> <p>i NOTE: To view this option, enable Advanced Setup mode as described in View Advanced Setup options.</p>
Enable UEFI Bluetooth Stack	<p>If enabled, UEFI Bluetooth protocols are installed and available, allowing pre-OS Bluetooth HID features.</p> <p>By default, the Enable UEFI Network Stack option is enabled.</p> <p>i NOTE: To view this option, enable Advanced Setup mode as described in View Advanced Setup options.</p>
HTTP(s) Boot Feature	
HTTP(s) Boot	<p>When enabled, supports HTTP(s) boot on the client BIOS, which offers wired or wireless and HTTP/HTTPS connection options.</p> <p>i NOTE: To view this option, enable Advanced Setup mode as described in View Advanced Setup options.</p>
HTTP(s) Boot Modes	<p>In Auto Mode, the boot URL is obtained from the DHCP response; the boot URL specifies the HTTP Boot Server and location of the Network Boot Program (NBP) file. In Manual mode, the user enters the URL in the text box, which must start with <code>http://</code> or <code>https://</code> and end with the NBP file name.</p> <p>By default, Auto Mode is selected.</p> <p>i NOTE: To view this option, enable Advanced Setup mode as described in View Advanced Setup options.</p>
Boot URL	<p>Displays the URL of boot path.</p> <p>i NOTE: To view this option, enable Advanced Setup mode as described in View Advanced Setup options.</p>
CA Certificate	<p>Upload or delete the CA certificate.</p> <p>i NOTE: To view this option, enable Advanced Setup mode as described in View Advanced Setup options.</p>

Table 39. System Setup options—Power menu

Power	
Battery Configuration	<p>Enables or disables the computer to run on battery during peak power usage hours. Use the table Custom Charge Start and Custom Charge Stop, to prevent AC power usage between certain times of each day.</p> <p>By default, the Adaptive option is selected. Battery settings are adaptively optimized based on your typical battery usage pattern.</p> <p>i NOTE: To view this option, enable Advanced Setup mode as described in View Advanced Setup options.</p>
Advanced Configuration	
Enable Advanced Battery Charge Configuration	<p>Enables Advanced Battery Charge Configuration from the beginning of the day to a specified work period. When enabled, Advanced Battery Charged maximizes battery health while still supporting heavy use during the work day.</p>

Table 39. System Setup options—Power menu (continued)

Power	
	<p>By default, the Enable Advanced Battery Charge Configuration option is disabled.</p> <p>i NOTE: To view this option, enable Advanced Setup mode as described in View Advanced Setup options.</p>
Peak Shift	
Enable Peak Shift	<p>Enables or disables the computer to run on battery during peak power usage hours.</p> <p>By default, the Enable Peak Shift option is disabled.</p> <p>i NOTE: To view this option, enable Advanced Setup mode as described in View Advanced Setup options.</p>
Type-C Connector Power	
Type-C Connector Power	<p>Enables the maximum power that can be drawn from the Type-C connector.</p> <p>By default, the 7.5 Watts option is disabled.</p> <p>i NOTE: To view this option, enable Advanced Setup mode as described in View Advanced Setup options.</p>
USB Powershare	
Enable USB PowerShare	<p>Enables or disables the USB PowerShare on the computer.</p> <p>By default, the USB Powershare option is disabled.</p> <p>i NOTE: To view this option, enable Advanced Setup mode as described in View Advanced Setup options.</p>
Thermal Management	
	<p>This setting allows for cooling of fan and processor heat management to adjust system performance, noise and temperature.</p> <p>By default, the Optimized option is selected.</p> <p>i NOTE: To view this option, enable Advanced Setup mode as described in View Advanced Setup options.</p>
USB Wake Support	
Wake on Dell USB-C Dock	<p>When enabled, connecting a Dell USB-C Dock wakes the computer from Standby, Hibernate, and Power Off.</p> <p>By default, the Wake on Dell USB-C Dock option is enabled.</p> <p>i NOTE: To view this option, enable Advanced Setup mode as described in View Advanced Setup options.</p>
Block Sleep	
	<p>Enables or disables the computer from entering Sleep (S3) mode in the operating system.</p> <p>By default, the Block Sleep option is disabled.</p> <p>i NOTE: When enabled, the computer does not go to Sleep, Intel Rapid Start is disabled automatically, and the operating system power option is blank if it was set to Sleep.</p> <p>i NOTE: To view this option, enable Advanced Setup mode as described in View Advanced Setup options.</p>
Lid Switch	
Enable Lid Switch	<p>Enables or disables the Lid Switch.</p> <p>By default, the Enable Lid Switch option is enabled.</p>

Table 39. System Setup options—Power menu (continued)

Power	
Power On Lid Open	<p>When enabled, allows the computer to turn on from the off state whenever the lid is opened.</p> <p>By default, the Power On Lid Open option is enabled.</p>
Intel Speed Shift Technology	<p>Enables or disables the Intel Speed Shift Technology support. When enabled, the operating system selects the appropriate processor performance automatically.</p> <p>By default, the Intel Speed Shift Technology option is enabled.</p> <p>NOTE: To view this option, enable Service options as described in View Service options.</p>

Table 40. System Setup options—Security menu

Security	
TPM 2.0 Security	
TPM 2.0 Security On	<p>Enables or disables the TPM.</p> <p>By default, the TPM 2.0 Security On option is enabled.</p> <p>For additional security, Dell Technologies recommends keeping TPM enabled to allow these security technologies to fully function.</p> <p>NOTE: To view this option, enable Advanced Setup mode as described in View Advanced Setup options.</p>
Attestation Enable	<p>The Attestation Enable option controls the endorsement hierarchy of TPM. Disabling the Attestation Enable option prevents TPM from being used to digitally sign certificates.</p> <p>By default, the Attestation Enable option is enabled.</p> <p>For additional security, Dell Technologies recommends keeping the Attestation Enable option enabled.</p> <p>NOTE: When disabled, this feature may cause compatibility issues or loss of functionality in some operating systems.</p> <p>NOTE: To view this option, enable Advanced Setup mode as described in View Advanced Setup options.</p>
Key Storage Enable	<p>The Key Storage Enable option controls the storage hierarchy of TPM, which is used to store digital keys. Disabling the Key Storage Enable option restricts the ability of TPM to store owner's data.</p> <p>By default, the Key Storage Enable option is enabled.</p> <p>For additional security, Dell Technologies recommends keeping the Key Storage Enable option enabled.</p> <p>NOTE: When disabled, this feature may cause compatibility issues or loss of functionality in some operating systems.</p> <p>NOTE: To view this option, enable Advanced Setup mode as described in View Advanced Setup options.</p>
Clear	<p>When enabled, the Clear option clears information that is stored in the TPM after exiting the system's BIOS. This option returns to the disabled state when the computer restarts.</p> <p>By default, the Clear option is disabled.</p> <p>Dell Technologies recommends enabling the Clear option only when TPM data is required to be cleared.</p>

Table 40. System Setup options—Security menu (continued)







Security	
	<p> NOTE: To view this option, enable Advanced Setup mode as described in View Advanced Setup options.</p>
Physical Presence Interface (PPI) Bypass for Clear Commands	<p>The PPI Bypass for Clear Commands option allows the operating system to manage certain aspects of PTT. When enabled, you are not prompted to confirm changes to the PTT configuration.</p> <p>By default, the PPI Bypass for Clear Commands option is disabled.</p> <p>For additional security, Dell Technologies recommends keeping the PPI Bypass for Clear Commands option disabled.</p> <p> NOTE: To view this option, enable Advanced Setup mode as described in View Advanced Setup options.</p>
Intel Total Memory Encryption	
Multi-Key Total Memory Encryption (Up to 16Keys)	<p>Enables or disables the processor’s memory encryption feature.</p> <p>By default, the Multi-Key Total Memory Encryption (Up to 16Keys) option is disabled.</p> <p> NOTE: To view this option, enable Advanced Setup mode as described in View Advanced Setup options.</p>
Chassis Intrusion	
Chassis Intrusion	<p>Enables or disables the detection of chassis intrusion events. This feature notifies the user when the base cover has been removed from the computer.</p> <p>When set to Enabled, a notification is displayed on the next boot and the event is logged in the BIOS Events log.</p> <p>When set to Disabled, no notification is displayed and no event is logged in the BIOS Events log.</p> <p>When set to On-Silent, the event is logged in the BIOS Events log, but no notification is displayed.</p> <p>By default, the Chassis Intrusion Detection option is disabled.</p> <p>For additional security, Dell Technologies recommends keeping the Chassis Intrusion option enabled.</p> <p> NOTE: To view this option, enable Advanced Setup mode as described in View Advanced Setup options.</p>
Block Boot Until Cleared	<p>The Block Boot Until Clear option is enabled when Chassis Intrusion is enabled. When enabled, the computer does not boot until the chassis intrusion is cleared.</p> <p> NOTE: To view this option, enable Advanced Setup mode as described in View Advanced Setup options.</p>
SMM Security Mitigation	
	<p>Enables or disables additional UEFI SMM Security Mitigation protections. This option uses the Windows SMM Security Mitigations Table (WSMT) to confirm to the operating system that security best practices have been implemented by the UEFI firmware.</p> <p>By default, the SMM Security Mitigation option is enabled.</p> <p>For additional security, Dell Technologies recommends keeping the SMM Security Mitigation option enabled unless you have a specific application which is not compatible.</p> <p> NOTE: This feature may cause compatibility issues or loss of functionality with some legacy tools and applications.</p>

Table 40. System Setup options—Security menu (continued)









Security	
	<p> NOTE: To view this option, enable Service options as described in View Service options.</p>
Data Wipe on Next Boot	
Start Data Wipe	<p>Data Wipe is a secure wipe operation that deletes information from a storage device.</p> <p> CAUTION: The secure Data Wipe operation deletes information in a way that it cannot be reconstructed.</p> <p>Commands such as delete and format in the operating system may remove files from showing up in the file system. However, they can be reconstructed through forensic means as they are still represented on the physical media. Data Wipe prevents this reconstruction and the data can no longer be recovered.</p> <p>When enabled, the data wipe option provides prompts to wipe any storage devices that are connected to the computer on the next boot.</p> <p>By default, the Start Data Wipe option is disabled.</p> <p> NOTE: To view this option, enable Advanced Setup mode as described in View Advanced Setup options.</p>
HDD Security	
	<p>This options controls the mechanism used by BIOS to block external Self Encrypting Drives (SED) management software to take ownership of the SED. The options are:</p> <ul style="list-style-type: none"> • SED Block SID Authentication • PPI Bypass for SED Block SID Command <p>Both the options are disabled by default.</p> <p> NOTE: This option is applicable with laptops shipped with SED.</p> <p> NOTE: To view this option, enable Advanced Setup mode as described in View Advanced Setup options.</p>
Absolute	
	<p>Absolute Software provides various cyber security solutions, some requiring software preloaded on Dell computers and integrated into the BIOS. To use these features, you must enable the Absolute BIOS setting and contact Absolute for configuration and activation.</p> <p>By default, the Absolute option is enabled.</p> <p>For additional security, Dell Technologies recommends keeping the Absolute option enabled.</p> <p> WARNING: The Permanently Disabled option can only be selected once. When Permanently Disabled is selected, Absolute Persistence cannot be reenabled. No further changes to the Enable/Disable states are allowed.</p> <p> NOTE: The Enable/Disable options are unavailable while the computer is in the activated state.</p> <p> NOTE: When the Absolute features are activated, the Absolute integration cannot be disabled from the BIOS Setup screen.</p>
UEFI Boot Path Security	
	<p>Enables or disables the computer to prompt the user to enter the Administrator password (if set) when booting to a UEFI boot path device from the F12 boot menu.</p> <p>By default, the Always Except Internal HDD option is enabled.</p> <p> NOTE: To view this option, enable Advanced Setup mode as described in View Advanced Setup options.</p>

Table 40. System Setup options—Security menu (continued)





Security	
Authenticated BIOS Interface	
Enable Authenticated BIOS Interface	Enables or disables the authenticated BIOS Interface.  NOTE: To view this option, enable Advanced Setup mode as described in View Advanced Setup options .
Clear Certificate Store	Deletes the certificate.  NOTE: To view this option, enable Advanced Setup mode as described in View Advanced Setup options .
Legacy Manageability Interface Access	Helps to access the Legacy Manageability Interface.  NOTE: To view this option, enable Advanced Setup mode as described in View Advanced Setup options .
Firmware Device Tamper Detection	Allows you to control the firmware device tamper detection feature. This feature notifies the user when the firmware device is tampered. When enabled, a screen warning message is displayed on the computer and a tamper detection event is logged in the BIOS Events log. The computer fails to reboot until the event is cleared. By default, the Firmware Device Tamper Detection option is enabled. For additional security, Dell Technologies recommends keeping the Firmware Device Tamper Detection option enabled.
Clear Firmware Device Tamper Detection	Allows you to clear the events that are logged when tampering of firmware device is detected. By default, the Clear Firmware Device Tamper Detection option is disabled.
Pluton Security Processor	Enables or disables the utilization of the Pluton Security Processor by the operating system to provide security services such as Key Storage Provider functionality. By default, the Pluton Security Processor option is enabled.  NOTE: To view this option, enable Advanced Setup mode as described in View Advanced Setup options .

Table 41. System Setup options—Passwords menu

Passwords	
Administrator Password	The Administrator Password prevents unauthorized access to the BIOS Setup options. Once the administrator password is set, the BIOS Setup options can only be modified after providing the correct password. The following rules and dependencies apply to the Administrator Password - <ul style="list-style-type: none"> • The administrator password cannot be set if system and/or internal storage passwords are previously set. • The administrator password can be used in place of the system and/or internal storage passwords. • When set, the administrator password must be provided during a firmware update. • Clearing the administrator password also clears the system password (if set). Dell Technologies recommends using an administrator password to prevent unauthorized changes to BIOS Setup options.
System Password	The System Password prevents the computer from booting to an operating system without entering the correct password.

Table 41. System Setup options—Passwords menu (continued)

Passwords	
	<p>The following rules and dependencies apply when the System Password is used -</p> <ul style="list-style-type: none"> ● The computer shuts down when idle for approximately 10 minutes at the system password prompt. ● The computer shuts down after three incorrect attempts to enter the system password. ● The computer shuts down when the Esc key is pressed at the System Password prompt. ● The system password is not prompted when the computer resumes from standby mode. <p>Dell Technologies recommends using the system password in situations where it is likely that a computer may be lost or stolen.</p>
<p>Hard Drive Password</p> <p>i NOTE: On some computers, the M.2 PCIe SSD-0 Password option is shown.</p>	<p>The hard drive password can be set to prevent unauthorized access of the data stored on the solid-state drive. The computer prompts for the hard drive password during boot in order to unlock the drive. A password-secured hard drive stays locked even when removed from the computer or placed into another computer. It prevents an attacker from accessing data on the drive without authorization.</p> <p>The following rules and dependencies apply when the Hard Drive Password or M.2 PCIe SSD-0 Password option is used.</p> <ul style="list-style-type: none"> ● The hard drive password option cannot be accessed when the hard drive is disabled in the BIOS Setup. ● The computer shuts down when idle for approximately 10 minutes at the hard drive password prompt. ● The computer shuts down after three incorrect attempts to enter the hard drive password and treats the hard drive as not available. ● The hard drive does not accept password unlock attempts after five incorrect attempts to enter the hard drive password from the BIOS Setup. The hard drive password must be reset for the new password unlock attempts. ● The computer treats the hard drive as not available when the Esc key is pressed at the hard drive password prompt. ● The hard drive password is not prompted when the computer resumes from standby mode. When the hard drive is unlocked by the user before the computer goes into standby mode, it remains unlocked after the computer resumes from standby mode. ● If the system and hard drive passwords are set to the same value, the hard drive unlocks after the correct system password is entered. <p>Dell Technologies recommends using a hard drive password to protect unauthorized data access.</p>
<p>Password Configuration</p>	<p>The Password configuration page includes several options for changing the requirements of BIOS passwords. You can modify the minimum and maximum length of the passwords as well as require passwords to contain certain character classes (upper case, lower case, digit, special character).</p> <p>When the Lower Case Letter option is enabled, the password requires at least one lower case letter.</p> <p>When the Upper Case Letter option is enabled, the password requires at least one upper case letter.</p> <p>When the Digit option is enabled, the password requires at least one numeric digit.</p> <p>When the Special Character option is enabled, the password requires at least one special character from the set: !"#%&'()*+,-./:;<=>?@[\\]^_`{ }~.</p> <p>When setting Minimum Characters for password length, Dell Technologies recommends setting the minimum password length to at least eight characters.</p>

Table 41. System Setup options—Passwords menu (continued)

Passwords	
	<p>i NOTE: To view this option, enable Advanced Setup mode as described in View Advanced Setup options.</p>
Password Bypass	<p>The Password Bypass option allows the computer to reboot from the operating system without entering the system or hard drive password. If the computer has already booted to the operating system, it is presumed that the user has already entered the correct system or hard drive password.</p> <p>i NOTE: This option does not remove the requirement to enter the password after shutting down.</p> <p>By default, the Password Bypass option is disabled.</p> <p>For additional security, Dell Technologies recommends keeping the Password Bypass option enabled.</p> <p>i NOTE: To view this option, enable Advanced Setup mode as described in View Advanced Setup options.</p>
Password Changes	
Allow Non-Admin Password Changes	<p>The Allow Non-Admin Password Changes option in BIOS Setup allows an end user to set or change the system or hard drive passwords without entering the administrator password. This gives an administrator control over the BIOS settings but enables an end user to provide their own password.</p> <p>By default, the Allow Non-Admin Password Changes option is enabled.</p> <p>For additional security, Dell Technologies recommends keeping the Allow Non-Admin Password Changes option disabled.</p> <p>i NOTE: To view this option, enable Advanced Setup mode as described in View Advanced Setup options.</p>
Admin Setup Lockout	
Enable Admin Setup Lockout	<p>The Admin Setup Lockout option prevents an end user from even viewing the BIOS Setup configuration without first entering the administrator password (if set).</p> <p>By default, the Enable Admin Setup Lockout option is disabled.</p> <p>For additional security, Dell Technologies recommends keeping the Admin Setup Lockout option disabled.</p> <p>i NOTE: To view this option, enable Advanced Setup mode as described in View Advanced Setup options.</p>
Master Password Lockout	
Enable Master Password Lockout	<p>The Master Password Lockout option allows you to disable the Recovery Password feature. If the system, administrator, or hard drive password is forgotten, the computer becomes unusable.</p> <p>i NOTE: When the owner password is set, the Master Password Lockout option is not available.</p> <p>i NOTE: When an internal hard drive password is set, it must first be cleared before Master Password Lockout can be changed.</p> <p>By default, the Enable Master Password Lockout option is disabled.</p> <p>Dell Technologies does not recommend enabling the Master Password Lockout unless you have implemented your own password recovery system.</p> <p>i NOTE: To view this option, enable Advanced Setup mode as described in View Advanced Setup options.</p>
Allow Non-Admin PSID Revert	

Table 41. System Setup options—Passwords menu (continued)

Passwords	
Enable Allow Non-Admin PSID Revert	<p>The Allow Non-Admin PSID Revert option allows a user to clear the hard drive password without entering the BIOS Admin Password. When an Admin Password is set, the ability to enter the PSID is protected by requiring authentication with the Admin Password. If this option is enabled, any user can clear the drive without entering the Admin Password.</p> <p>By default, the Enable Allow Non-Admin PSID Revert option is disabled.</p> <p>NOTE: To view this option, enable Advanced Setup mode as described in View Advanced Setup options.</p>

Table 42. System Setup options—System Management menu

System Management	
Service Tag	Displays the Service Tag of the computer.
Asset Tag	<p>Creates a computer Asset Tag that an IT administrator can use to uniquely identify a particular computer.</p> <p>NOTE: Once set in the BIOS, the Asset Tag cannot be changed.</p>
Wake on AC	<p>Enables or disables the computer to turn on and go to boot when AC power is supplied to the computer.</p> <p>By default, the Wake on AC option is disabled.</p> <p>NOTE: To view this option, enable Advanced Setup mode as described in View Advanced Setup options.</p>
Wake on LAN	<p>Enables or disables the computer to turn on by a special LAN signal.</p> <p>By default, the Wake on LAN option is disabled.</p> <p>NOTE: To view this option, enable Advanced Setup mode as described in View Advanced Setup options.</p>
Auto On Time	<p>Enable to set the computer to turn on automatically every day or on a preselected date and time. This option can be configured only if the Auto On Time is set to Everyday, Weekdays, or Selected Days.</p> <p>By default, the Auto On Time option is disabled.</p> <p>NOTE: To view this option, enable Advanced Setup mode as described in View Advanced Setup options.</p>
Intel AMT capability	<p>Configure Intel Active Management Technology (AMT) options, which can be enabled, disabled, or restricted.</p> <p>NOTE: To view this option, enable Advanced Setup mode as described in View Advanced Setup options.</p>
Set Ownership Date	Displays the date of the computer when it was powered on the first time.
Diagnostics OS agent requests	<p>Enable or disable the option for applications running in the operating system to run with preboot diagnostics on subsequent boots.</p> <p>NOTE: To view this option, enable Advanced Setup mode as described in View Advanced Setup options.</p>
Power-On-Self-Test Automatic Recovery	<p>Enable or disable the automatic recovery of the computer from no power or no-POST failure by applying mitigation steps.</p> <p>By default, the Power-On-Self-Test Automatic Recovery option is enabled.</p> <p>NOTE: To view this option, enable Advanced Setup mode as described in View Advanced Setup options.</p>

Table 43. System Setup options—Keyboard menu

Keyboard	
Fn Lock Options	
Fn Lock Options	<p>Enables or disables the Fn Lock option.</p> <p>By default, the Fn Lock option is enabled.</p> <p>i NOTE: To view this option, enable Advanced Setup mode as described in View Advanced Setup options.</p>
Lock Mode	<p>By default, the Lock Mode Secondary option is enabled. With this option, the F1-F12 keys scan the code for their secondary functions.</p> <p>i NOTE: To view this option, enable Advanced Setup mode as described in View Advanced Setup options.</p>
Keyboard Illumination	
	<p>Configures the operating mode of the keyboard illumination feature.</p> <p>By default, the Dim option is selected. Enables the keyboard illumination feature at 100% brightness level.</p>
Keyboard Backlight Timeout on AC	
	<p>Sets the timeout value for the keyboard backlight when an AC adapter is connected to the computer.</p> <p>By default, the 10 seconds option is selected.</p>
Keyboard Backlight Timeout on Battery	
	<p>Sets the timeout value for the keyboard backlight when the computer is running only on the battery power. The keyboard backlight timeout value is only effective when the backlight is enabled.</p> <p>By default, the 10 seconds option is selected.</p>
Device Configuration HotKey Access	
	<p>Allows you to control whether you can access device configuration screens through hotkeys during system startup.</p> <p>By default, the Device Configuration HotKey Access option is enabled.</p> <p>i NOTE: This setting controls only the Intel RAID (CTRL+I), MEBX (CTRL+P), and LSI RAID (CTRL+C) Option ROMs. Other preboot Option ROMs, which support entry using a key sequence, are not affected by this setting.</p> <p>i NOTE: To view this option, enable Advanced Setup mode as described in View Advanced Setup options.</p>

Table 44. System Setup options—Pre-boot Behavior menu

Pre-boot Behavior	
Adapter Warnings	
Enable Adapter Warning	<p>Enables the warning messages during boot when the adapters with less power capacity are detected.</p> <p>By default, the Enable Adapter Warning option is enabled.</p>
Warnings and Errors	
	<p>Enables or disables the action to be taken when a warning or error is encountered.</p> <p>By default, the Prompt on Warnings and Errors option is selected.</p> <p>i NOTE: Errors deemed critical to the operation of the computer hardware stop the functioning of the computer.</p>
Extend BIOS POST Time	
	<p>Sets the BIOS POST (Power-On Self-Test) load time.</p> <p>By default, the 0 seconds option is selected.</p> <p>i NOTE: To view this option, enable Advanced Setup mode as described in View Advanced Setup options.</p>

Table 44. System Setup options—Pre-boot Behavior menu (continued)



Pre-boot Behavior	
MAC Address Pass-Through	Replaces the external NIC MAC address (in a supported dock or dongle) with the selected MAC address from the computer. By default, the System Unique MAC Address option is selected.
Sign of Life	
Early Logo Display	Displays the Logo Sign of Life. By default, the Early Logo Display option is enabled.  NOTE: To view this option, enable Advanced Setup mode as described in View Advanced Setup options .
Collaboration Touchpad	Enables or disables the Collaboration Touchpad. By default, the Collaboration Touchpad option is enabled.  NOTE: To view this option, enable Advanced Setup mode as described in View Advanced Setup options .
Show Ownership Tag with Logo	Displays the ownership tag of the computer.  NOTE: To view this option, enable Advanced Setup mode as described in View Advanced Setup options .

Table 45. System Setup options—Performance menu





Performance	
Multi-Core Support	
Active Multiple Performances Cores (P-Cores) Select	Allows to change the number of the CPU cores available to the OS. By default, the All Active option is enabled.  NOTE: To view this option, enable Service options as described in View Service options .
Active Multiple Efficient Cores (E-Cores) Select	Allows to change the number of the CPU E-xcores available to the OS. By default, the All Active option is enabled.  NOTE: To view this option, enable Service options as described in View Service options .
Intel SpeedStep	
Enable Intel SpeedStep Technology	Enables the computer to dynamically adjust processor voltage and core frequency, decreasing average power consumption and heat production. By default, the Enable Intel SpeedStep Technology option is enabled.  NOTE: To view this option, enable Advanced Setup mode as described in View Advanced Setup options .
C-State Control	
Enable C-State Control	Enables or disables the ability of the CPU to enter and exit low-power state. When disabled, it disables all C-states. When enabled, it enables all C-states that the chipset or platform allows. By default, the Enable C-State Control option is enabled.  NOTE: To view this option, enable Service options as described in View Service options .
Intel Turbo Boost Technology	

Table 45. System Setup options—Performance menu (continued)

Performance	
Enable Intel Turbo Boost Technology	<p>Enables or disables the Intel TurboBoost mode of the processor. When enabled, the Intel TurboBoost driver increases the performance of the CPU or graphics processor.</p> <p>By default, the Enable Intel Turbo Boost Technology option is enabled.</p> <p>i NOTE: To view this option, enable Service options as described in View Service options.</p>

Table 46. System Setup options—System Logs menu

System Logs	
BIOS Event Log	
Clear BIOS Event Log	<p>Select the option to keep or clear BIOS events logs.</p> <p>By default, the Keep Log option is selected.</p>
Thermal Event Log	
Clear Thermal Event Log	<p>Select the option to keep or clear thermal events logs.</p> <p>By default, the Keep Log option is selected.</p>
Power Event Log	
Clear Power Event Log	<p>Select the option to keep or clear power events logs.</p> <p>By default, the Keep Log option is selected.</p>

Table 47. System Setup options—Update, Recovery menu

Update, Recovery	
UEFI Capsule Firmware Updates	
Enable UEFI Capsule Firmware Updates	<p>Enables or disables BIOS updates through UEFI capsule update packages.</p> <p>i NOTE: Disabling this option blocks the BIOS updates from services such as Microsoft Windows Update and Linux Vendor Firmware Service (LVFS).</p> <p>By default, the Enable UEFI Capsule Firmware Updates option is enabled.</p> <p>i NOTE: To view this option, enable Service options as described in View Service options.</p>
BIOS Recovery from Hard Drive	
	<p>Enables or disables the user to recover from certain corrupted BIOS conditions from a recovery file on the user primary hard drive or an external USB drive.</p> <p>By default, the BIOS Recovery from Hard Drive option is enabled.</p> <p>i NOTE: BIOS Recovery from Hard Drive is not available for self-encrypting drives (SED).</p> <p>i NOTE: BIOS recovery is designed to fix the main BIOS block and cannot work if the Boot Block is damaged. In addition, this feature cannot work in the event of EC corruption, ME corruption, or a hardware issue. The recovery image must exist on an unencrypted partition on the drive.</p> <p>i NOTE: To view this option, enable Advanced Setup mode as described in View Advanced Setup options.</p>
BIOS Downgrade	
Allow BIOS Downgrade	<p>Allows downgrading of the system firmware to previous revisions.</p> <p>By default, the Allow BIOS Downgrade option is enabled.</p>

Table 47. System Setup options—Update, Recovery menu (continued)

Update, Recovery	
	<p> NOTE: To view this option, enable Advanced Setup mode as described in View Advanced Setup options.</p>
SupportAssist OS Recovery	<p>Enables or disables the boot flow for SupportAssist OS Recovery tool if certain system errors occur.</p> <p>By default, the SupportAssist OS Recovery option is enabled.</p>
BIOSConnect	<p>Enables or disables cloud service operating system recovery if the main operating system fails to boot with the number of failures equal to or greater than the value specified by the Auto OS Recovery Threshold setup option and local service operating system does not boot or is not installed.</p> <p>By default, the BIOSConnect option is enabled.</p>
Dell Auto OS Recovery Threshold	<p>Allows the control of the automatic boot flow for the SupportAssist System Resolution Console and the Dell OS Recovery Tool.</p> <p>By default, the Dell Auto OS Recovery Threshold value is set to 2.</p>

Table 48. System Setup options—Virtualization menu





Virtualization Support	
Intel Virtualization Technology	
Enable Intel Virtualization Technology (VT)	<p>When enabled, the computer can run a Virtual Machine Monitor (VMM).</p> <p>By default, the Enable Intel Virtualization Technology (VT) option is enabled.</p> <p> NOTE: To view this option, enable Service options as described in View Service options.</p>
VT for Direct I/O	
Enable Intel VT for Direct I/O	<p>When enabled, the computer can perform Virtualization Technology for Direct I/O (VT-d). VT-d is an Intel method that provides virtualization for memory map I/O.</p> <p>By default, the Enable Intel VT for Direct I/O option is enabled.</p> <p> NOTE: To view this option, enable Service options as described in View Service options.</p>
Intel Trusted Execution Technology (TXT)	<p>Specifies whether a measured Virtual Machine Monitor (MVMM) can use the additional hardware capabilities provided by Intel Trusted Execution Technology. The following must be enabled in order to enable Intel TXT -</p> <ul style="list-style-type: none"> ● Trusted Platform Module (TPM) ● Intel Hyper-Threading ● All CPU cores (Multi-Core Support) ● Intel Virtualization Technology ● Intel VT for Direct I/O <p>By default, the Intel Trusted Execution Technology (TXT) option is disabled.</p> <p> NOTE: To view this option, enable Advanced Setup mode as described in View Advanced Setup options.</p>
DMA Protection	
Enable Pre-Boot DMA Support	<p>Allows you to control the Pre-Boot DMA protection for both internal and external ports. This option does not directly enable DMA protection in the operating system.</p> <p> NOTE: This option is not available when the virtualization setting for IOMMU is disabled (VT-d/AMD Vi).</p>

Table 48. System Setup options—Virtualization menu (continued)

Virtualization Support	
	<p>By default, the Enable Pre-Boot DMA Support option is enabled.</p> <p>For additional security, Dell Technologies recommends keeping the Enable Pre-Boot DMA Support option enabled.</p> <p>NOTE: This option is provided only for compatibility purposes, since some older hardware is not DMA capable.</p> <p>NOTE: To view this option, enable Advanced Setup mode as described in View Advanced Setup options.</p>
Enable OS Kernel DMA Support	<p>Allows you to control the Kernel DMA protection for both internal and external ports. This option does not directly enable DMA protection in the operating system. For operating systems that support DMA protection, this setting indicates to the operating system that the BIOS supports the feature.</p> <p>NOTE: This option is not available when the virtualization setting for IOMMU is disabled (VT-d/AMD Vi).</p> <p>By default, the Enable OS Kernel DMA Support option is enabled.</p> <p>NOTE: This option is provided only for compatibility purposes, since some older hardware is not DMA capable.</p> <p>NOTE: To view this option, enable Advanced Setup mode as described in View Advanced Setup options.</p>
Internal Port DMA Compatibility Mode	<p>Allows you to control the boot compatibility for integrated PCIe peripherals by disabling PCIe DMA protection on internal PCIe ports.</p> <p>When enabled, BIOS will notify the operating system that the internal ports are not DMA capable. This option is to help with devices that have operating system DMA compatibility issues. This option does not directly enable DMA protection in the operating system.</p> <p>NOTE: This option is not available when the virtualization setting for IOMMU is disabled (VT-d/AMD Vi).</p> <p>By default, the Internal Port DMA Compatibility Mode option is disabled.</p> <p>NOTE: This option is provided only for compatibility purposes, as certain older hardware may not be DMA compliant.</p> <p>NOTE: To view this option, enable Advanced Setup mode as described in View Advanced Setup options.</p>

Updating the BIOS

Updating the BIOS in Windows

Steps

1. Go to [Dell Support Site](#).
2. Go to **Identify your product or search support**. In the box, enter the product identifier, model, service request or describe what you are looking for, and then click **Search**.
 - NOTE:** If you do not have the Service Tag, use the SupportAssist to automatically identify your computer. You can also use the product ID or manually browse for your computer model.
3. Click **Drivers & Downloads**. Expand **Find drivers**.
4. Select the operating system installed on your computer.
5. In the **Category** drop-down list, select **BIOS**.

6. Select the latest version of BIOS, and click **Download** to download the BIOS file for your computer.
7. After the download is complete, browse the folder where you saved the BIOS update file.
8. Double-click the BIOS update file icon and follow the on-screen instructions.

For more information about how to update the system BIOS, search in the Knowledge Base Resource at [Dell Support Site](#).

Updating the BIOS using the USB drive in Windows

Steps

1. Go to [Dell Support Site](#).
2. Go to **Identify your product or search support**. In the box, enter the product identifier, model, service request or describe what you are looking for, and then click **Search**.
 **NOTE:** If you do not have the Service Tag, use the SupportAssist to automatically identify your computer. You can also use the product ID or manually browse for your computer model.
3. Click **Drivers & Downloads**. Expand **Find drivers**.
4. Select the operating system installed on your computer.
5. In the **Category** drop-down list, select **BIOS**.
6. Select the latest version of BIOS, and click **Download** to download the BIOS file for your computer.
7. Create a bootable USB drive. For more information, search the Knowledge Base Resource at [Dell Support Site](#).
8. Copy the BIOS Setup program file to the bootable USB drive.
9. Connect the bootable USB drive to the computer that needs the BIOS update.
10. Restart the computer and press **F12**.
11. Select the USB drive from the **One Time Boot Menu**.
12. Type the BIOS Setup program filename and press **Enter**.
The **BIOS Update Utility** appears.
13. Follow the on-screen instructions to complete the BIOS update.

Updating the BIOS in Linux and Ubuntu

To update the system BIOS on a computer that is installed with Linux or Ubuntu, see the knowledge base article [000131486](#) at [Dell Support Site](#).

Updating the BIOS from the One-Time boot menu

You can run the BIOS flash update file from Windows using a bootable USB drive or you can also update the BIOS from the One-Time boot menu on the computer. To update your computers BIOS, copy the BIOS XXXX.exe file onto a USB drive formatted with the FAT32 file system. Then, restart your computer and boot from the USB drive using the One-Time Boot Menu.

About this task

BIOS Update

To confirm if the BIOS Flash Update is listed as a boot option you can boot your computer to the **One Time Boot** Menu. If the option is listed, then the BIOS can be updated using this method.

To update your BIOS from the One-Time boot menu, you need the following:

- USB drive formatted to the FAT32 file system (the drive does not have to be bootable)
- BIOS executable file that you downloaded from the Dell Support website and copied to the root of the USB drive
- AC power adapter must be connected to the computer
- A functional computer battery to flash the BIOS

Perform the following steps to update the BIOS from the One-Time boot menu:

 **CAUTION: Do not turn off the computer during the BIOS flash update process. The computer may not boot if you turn off your computer.**

Steps

1. Turn off the computer, insert the USB drive that contains the BIOS flash update file.
2. Turn on the computer and press **F12** to access the **One Time Boot** Menu. Select **BIOS Update** using the mouse or arrow keys then press Enter.
The flash BIOS menu is displayed.
3. Click **Flash from file**.
4. Select the external USB device.
5. Select the file and double-click the flash target file, and then click **Submit**.
6. Click **Update BIOS**. The computer restarts to flash the BIOS.
7. The computer will restart after the BIOS flash update is completed.

System and setup password

 **CAUTION:** The password features provide a basic level of security for the data on your computer.

 **CAUTION:** Ensure that your computer is locked when it is not in use. Anyone can access the data that is stored on your computer, when left unattended.

Table 49. System and setup password

Password type	Description
System password	Password that you must enter to boot to your operating system.
Setup password	Password that you must enter to access and change the BIOS settings of your computer.

You can create a system password and a setup password to secure your computer.

 **NOTE:** The System and setup password feature is disabled by default.

Assigning a System Setup password

Prerequisites

You can assign a new System or Admin Password only when the status is set to **Not Set**. To enter BIOS System Setup, press F2 immediately after a power-on or reboot.

Steps

1. In the **System BIOS** or **System Setup** screen, select **Security** and press Enter.
The **Security** screen is displayed.
2. Select **System/Admin Password** and create a password in the **Enter the new password** field.
Use the following guidelines to create the system password:
 - A password can have up to 32 characters.
 - A password can at least have one special character: "(! " # \$ % & ' * + , - . / : ; < = > ? @ [\] ^ _ ` { | })"
 - A password can have numbers 0 to 9.
 - A password can have an upper case letters from A to Z.
 - A password can have a lower case letters from a to z.
3. Type the system password that you entered earlier in the **Confirm new password** field and click **OK**.
4. Press Y to save the changes.
The computer restarts.

Deleting or changing an existing system password or setup password

Prerequisites

Ensure that the **Password Status** is Unlocked in the System Setup before attempting to delete or change the existing system password and/or setup password. You cannot delete or change an existing system password or setup password if the **Password Status** is Locked. To enter the System Setup, press F2 immediately after a power-on or reboot.

Steps

1. In the **System BIOS** or **System Setup** screen, select **System Security** and press Enter. The **System Security** screen is displayed.
2. In the **System Security** screen, verify that the **Password Status** is Unlocked.
3. Select **System Password**. Update or delete the existing system password, and press Enter or Tab.
4. Select **Setup Password**. Update or delete the existing setup password, and press Enter or Tab.
 **NOTE:** If you change the system password and/or setup password, reenter the new password when prompted. If you delete the system password and/or setup password, confirm the deletion when prompted.
5. Press Esc. A message prompts you to save the changes.
6. Press Y to save the changes and exit from **System Setup**. The computer restarts.

Clearing system and setup passwords

About this task

To clear the system or setup passwords, contact Dell technical support as described at [Contact Support](#).

 **NOTE:** For information about how to reset Windows or application passwords, see the documentation accompanying Windows or your application.

Clearing Chassis Intrusion Alerts

A chassis intrusion switch identifies whenever the system base cover has been removed. You can enable alerts about any intrusions through the **Chassis Intrusion** option in the Security submenu of the BIOS setup menu.

Once enabled, the **Block Boot Until Cleared** feature allows you to select whether to prevent the bootup until the intrusion alert is resolved.

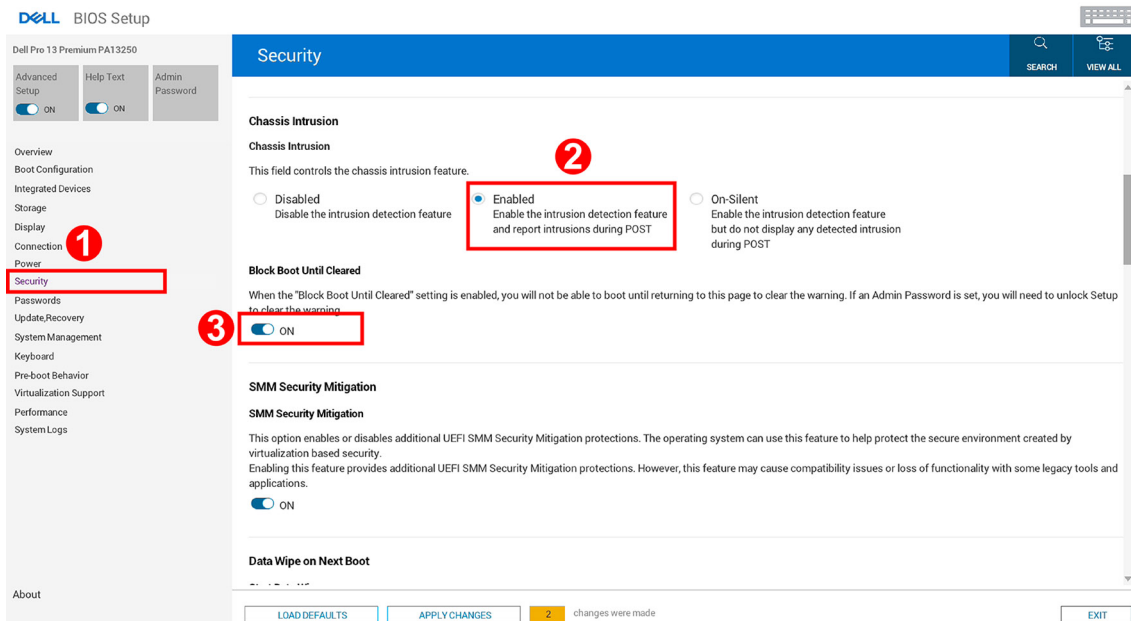

Figure 77. Block Boot Until Cleared

If **Block Boot Until Cleared** is set to **ON**, then you must select **BIOS-Setup** and clear the intrusion alert in order to boot up the computer normally.

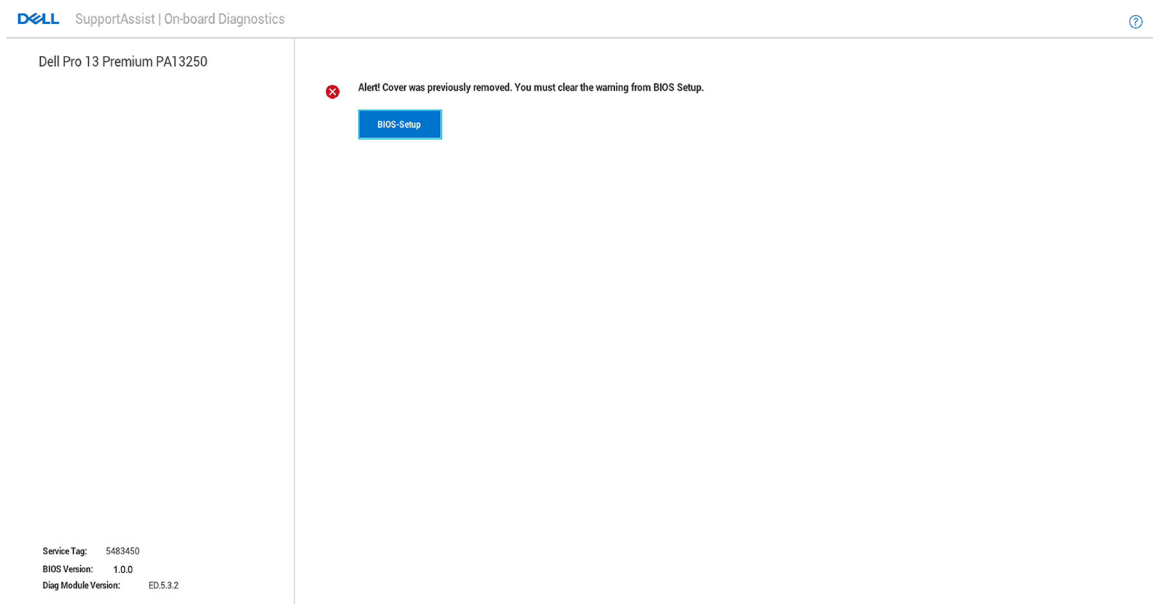

Figure 78. BIOS-Setup

When **Block Boot Until Cleared** is switch to **OFF**, you can choose either **Continue** to proceed with the normal computer boot-up or **BIOS-Setup** to clear the alert.

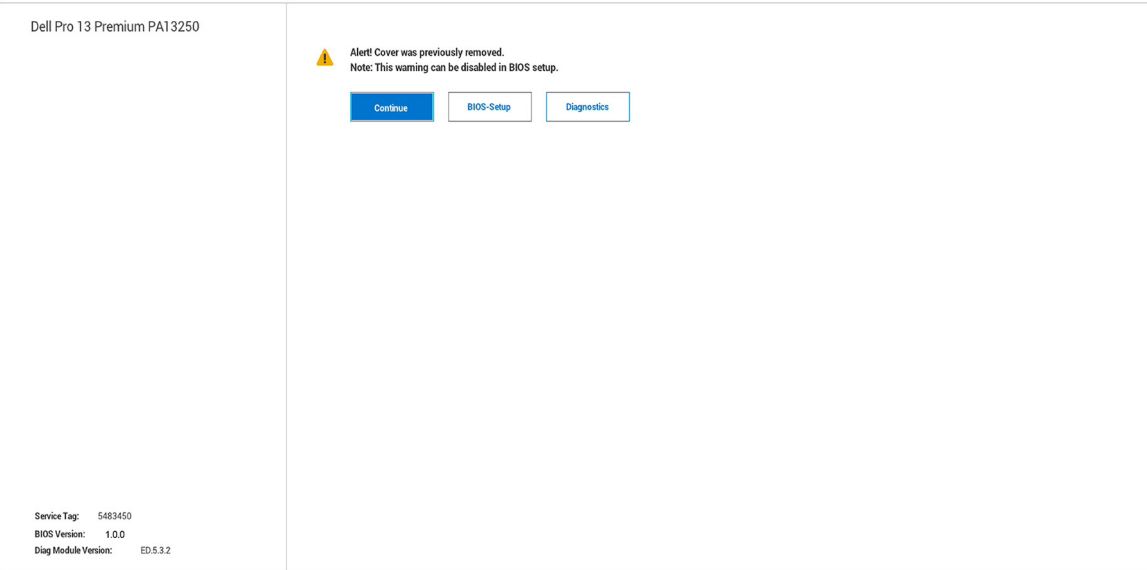

Figure 79. BIOS-Setup

NOTE: If the **Continue** option is selected, then you continue to see the alert each time the computer is turned on until the alert is cleared.

To clear the alert, select **ON** in the **Clear Intrusion Warning** field that is located within the **Security** sub-menu of the **BIOS setup** menu.

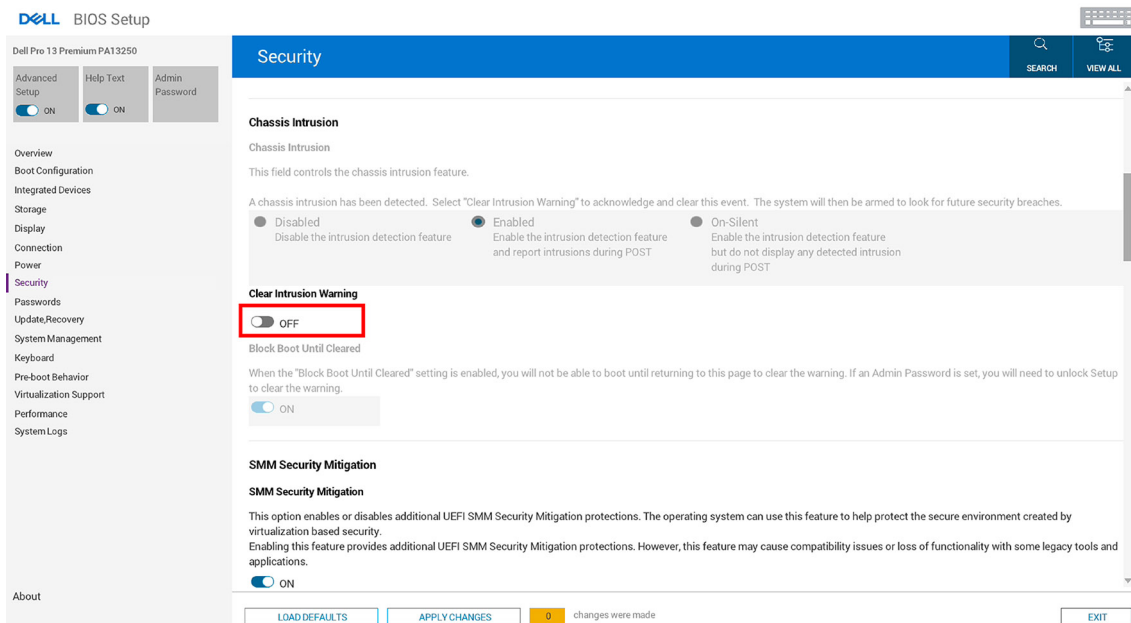

Figure 80. Clear Intrusion Warning

Troubleshooting

Handling swollen rechargeable Li-ion batteries

Like most laptops, Dell laptops use Lithium-ion batteries. One type of Lithium-ion battery is the rechargeable Li-ion battery. Rechargeable Li-ion batteries have increased in popularity in recent years and have become a standard in the electronics industry due to customer preferences for a slim form factor (especially with newer ultra-thin laptops) and long battery life. Inherent to rechargeable Li-ion battery technology is the potential for swelling of the battery cells.

A swollen battery may impact the performance of the laptop. To prevent possible further damage to the device enclosure or internal components leading to malfunction, discontinue the use of the laptop and discharge it by disconnecting the AC adapter and letting the battery drain.

Swollen batteries should not be used and must be replaced and disposed of properly. We recommend contacting Dell Support for options to replace a swollen battery under the terms of the applicable warranty or service contract, including options for replacement by a Dell authorized service technician.

The guidelines for handling and replacing rechargeable Li-ion batteries are as follows:

- Exercise caution when handling rechargeable Li-ion batteries.
- Discharge the battery before removing it from the laptop. To discharge the battery, unplug the AC adapter from the computer and operate the computer only on battery power. The battery is fully discharged when the computer no longer turns on when the power button is pressed.
- Do not crush, drop, mutilate, or penetrate the battery with foreign objects.
- Do not expose the battery to high temperatures, or disassemble battery packs and cells.
- Do not apply pressure to the surface of the battery.
- Do not bend the battery.
- Do not use tools of any type to pry on or against the battery.
- If a battery gets stuck in a device as a result of swelling, do not try to free it as puncturing, bending, or crushing a battery can be dangerous.
- Do not attempt to reassemble a damaged or swollen battery into a laptop.
- Swollen batteries that are covered under warranty should be returned to Dell in an approved shipping container (provided by Dell)—this is to comply with transportation regulations. Swollen batteries that are not covered under warranty should be disposed of at an approved recycling center. Contact Dell Support at [Dell Support Site](#) for assistance and further instructions.
- Using a non-Dell or incompatible battery may increase the risk of fire or explosion. Replace the battery only with a compatible battery purchased from Dell that is designed to work with your Dell computer. Do not use a battery from other computers with your computer. Always purchase genuine batteries from [Dell Site](#) or otherwise directly from Dell.

Rechargeable Li-ion batteries can swell for various reasons such as age, number of charge cycles, or exposure to high heat. For more information about how to improve the performance and lifespan of the laptop battery and to minimize the possibility of occurrence of the issue, search Dell laptop battery in the Knowledge Base Resource at [Dell Support Site](#).

Dell SupportAssist Pre-boot System Performance Check diagnostics

About this task

SupportAssist diagnostics (also known as system diagnostics) performs a complete check of your hardware. The Dell SupportAssist Pre-boot System Performance Check diagnostics is embedded within the BIOS and launched by the BIOS internally. The embedded system diagnostics provides options for particular devices or device groups allowing you to:

- Run tests automatically or in an interactive mode.
- Repeat the tests.
- Display or save test results.
- Run thorough tests to add more options and obtain details about any failed devices.

- View status messages that inform you when the tests are completed successfully.
- View error messages that inform you of problems encountered during testing.

NOTE: Some tests for specific devices require user interaction. Always ensure that you are present at the computer when the diagnostic tests are performed.

For more information, see the knowledge base article [000181163](#).

Running the SupportAssist Pre-Boot System Performance Check

Steps

1. Turn on your computer.
2. As the computer boots, press the F12 key.
3. On the boot menu screen, select **Diagnostics**.
The diagnostic quick test begins.
NOTE: For more information about running the SupportAssist Pre-Boot System Performance Check on a specific device, see [Dell Support Site](#).
4. If there are any issues, error codes are displayed.
Note the error code and validation number and contact Dell.

Built-in self-test (BIST)

(Motherboard Built-In Self-Test) M-BIST

M-BIST is the system board built-in self-test diagnostics tool that improves the diagnostics accuracy of system board Embedded Controller (EC) failures.

NOTE: M-BIST can be manually initiated before Power On Self-Test (POST).

How to run M-BIST

NOTE: Before initiating M-BIST, ensure that the computer is in a power-off state.

1. Press and hold both the **M** key and the power button to initiate M-BIST.
2. The battery indicator LED may exhibit two states:
 - Off: No fault was detected.
 - Amber and White: Indicates a problem with the system board.
3. If there is a failure with the system board, the battery status LED flashes one of the following error codes for 30 seconds:

Table 50. LED error codes

Blinking Pattern		Possible Problem
Amber	White	
2	1	CPU Failure
2	8	LCD Power Rail Failure
1	1	TPM Detection Failure
2	4	Memory/RAM failure

4. If there is no failure with the system board, the LCD cycles through the solid color screens (that are described in the LCD-BIST) for 30 seconds and then turn off.

Logical Built-in Self-test (L-BIST)

L-BIST is an enhancement to the single LED error code diagnostics and is automatically initiated during POST. L-BIST will check the LCD power rail. If there is no power being supplied to the LCD (that is if the L-BIST circuit fails), the battery status LED flashes either an error code [2,8] or an error code [2,7].

 **NOTE:** If L-BIST fails, LCD-BIST cannot function as no power will be supplied to the LCD.

How to invoke the L-BIST

1. Turn on your computer.
2. If the computer does not start up normally, look at the battery status LED:
 - If the battery status LED flashes an error code [2,7], the display cable may not be connected properly.
 - If the battery status LED flashes an error code [2,8], there is a failure on the LCD power rail of the system board, hence there is no power that is supplied to the LCD.
3. For cases, when a [2,7] error code is shown, check to see if the display cable is properly connected.
4. For cases when a [2,8] error code is shown, replace the system board.

LCD Built-in Self-Test (LCD-BIST)

Dell laptops have a built-in diagnostic tool that helps you determine if the screen abnormality you are experiencing is an inherent problem with the LCD (screen) of the Dell laptop or with the video card (GPU) and computer settings.

When you notice screen abnormalities like flickering, distortion, clarity issues, fuzzy or blurry image, horizontal or vertical lines, color fade, it is always a good practice to isolate the LCD (screen) by running the LCD-BIST.

How to invoke the LCD-BIST

1. Turn off your computer.
2. Disconnect any peripherals that are connected to the computer. Connect only the AC adapter (charger) to the computer.
3. Ensure that the LCD (screen) is clean (no dust particles on the surface of the screen).
4. Press and hold the **D** key and press the power button to enter LCD-BIST mode. Continue to hold the **D** key until the computer boots up.
5. The screen displays solid colors and changes colors on the entire screen to white, black, red, green, and blue twice.
6. Then it displays the colors white, black, and red.
7. Carefully inspect the screen for abnormalities (any lines, fuzzy color, or distortion on the screen).
8. At the end of the last solid color (red), the computer shuts down.

 **NOTE:** Dell SupportAssist Preboot diagnostics upon launch initiates an LCD-BIST first, expecting a user intervention to confirm functionality of the LCD.

System-diagnostic lights

This section lists the system-diagnostic lights of your Dell Pro 13 Premium PA13250.

The following table shows different Service LED blinking patterns and associated problems. The diagnostic light codes consist of a two-digit number, and the digits are separated by a comma. The number stands for a blinking pattern; the first digit shows the number of blinks in amber color, and the second digit shows the number of blinks in white color. The Service LED blinks in the following manner:

- The Service LED blinks the number of times equal to value of the first digit and turns off with a short pause.
- After that, the Service LED blinks the number of times equal to the value of the second digit.
- The Service LED turns off again with a longer pause.
- After the second pause, the blinking pattern will be repeated.

Table 51. Diagnostic light codes

Diagnostic light codes (Amber, White)	Problem description	Recommended solutions
1,1	TPM Detection Failure	Replace the system board.
1,2	Unrecoverable SPI Flash Failure	Replace the system board.
1,5	EC unable to program i-Fuse	Replace the system board.
1,6	Generic catch-all for ungraceful EC code flow errors	Disconnect all power source (AC, coin cell) and drain flea power by pressing and holding down the power button.
1,7	Non-RPMC Flash on Boot Guard fused system	Flash latest BIOS version. If the problem persists, replace the system board.
1,8	Chipset “Catastrophic Error” signal has tripped	Replace the CPU.
2,1	CPU configuration or CPU failure	Replace the CPU.
2,2	System board: BIOS or Read-Only Memory (ROM) failure	Flash latest BIOS version. If the problem persists, replace the system board.
2,3	No memory or Random-Access Memory (RAM) detected	Reseat and swap memory modules among the slots. If the problem persists, replace the memory module.
2,4	Memory or Random-Access Memory (RAM) failure	Reseat and swap memory modules among the slots. If the problem persists, replace the memory module.
2,5	Invalid memory installed	Reseat and swap memory modules among the slots. If the problem persists, replace the memory module.
2,6	System board/Chipset Error	Replace the system board.
2,7	LCD failure SBIOS message	Replace the display.
2,8	Display power-rail failure on the system board	Replace the system board.
3,1	CMOS battery failure	Reset the CMOS battery connection. If the problem persists, replace the RTC battery.
3,2	PCI of Video card/chip failure	Replace the system board.
3,3	Recovery image not found	Replace the system board.
3,4	Recovery image found but invalid	Replace the system board.
3,5	EC power-rail error	Replace the system board.
3,6	Flash corruption detected by SBIOS	Flash corruption is detected by SBIOS. If the problem persists, replace the system board.
3,7	Timeout waiting on ME to reply to HECI message	Replace the system board.
4,1	Memory DIMM power rail failure	Replace the system board.
4,2	CPU Power cable connection issue	<ul style="list-style-type: none"> • Perform the M-BIST Test, reseat the cable. • If this does not work, replace the system board, power supply or cabling.
4,4	LCD Power Rail Failure	Replace system board

Recovering the operating system

When your computer is unable to boot to the operating system even after repeated attempts, it automatically starts Dell SupportAssist OS Recovery.

Dell SupportAssist OS Recovery is a stand-alone tool that is preinstalled in Dell computers running the Windows operating system. It consists of tools to diagnose and troubleshoot issues that may occur before your computer boots to the operating

system. It enables you to diagnose hardware issues, repair your computer, back up your files, and restore your computer to its factory state.

You can also download it from the Dell Support website to troubleshoot and fix your computer when it fails to boot into the primary operating system due to software or hardware failures.

For more information about the Dell SupportAssist OS Recovery, see *Dell SupportAssist OS Recovery User's Guide at Serviceability Tools at the Dell Support Site*. Click **SupportAssist** and then click **SupportAssist OS Recovery**.

Real-Time Clock (RTC Reset)

The Real-Time Clock (RTC) reset function enables you or the service technician to recover Dell computers from No POST/No Power/No Boot situations.

Start the RTC reset with the computer powered off and connected to AC power. Press and hold the power button for twenty-five seconds and the power LED flashes twice. The computer RTC Reset occurs after you release the power button.

Backup media and recovery options

It is recommended to create a recovery drive to troubleshoot and fix problems that may occur with Windows. Dell provides multiple options for recovering the Windows operating system on your Dell computer. For more information, see [Dell Windows Backup Media and Recovery Options](#).

Network power cycle

About this task

If your computer is unable to access the Internet due to network connectivity issues, reset your network devices by performing the following steps:

Steps

1. Turn off the computer.
2. Turn off the modem.
 **NOTE:** Some Internet service providers (ISPs) provide a modem and router combo device.
3. Turn off the wireless router.
4. Wait for 30 seconds.
5. Turn on the wireless router.
6. Turn on the modem.
7. Turn on the computer.

Drain flea power (perform hard reset)

About this task

Flea power is the residual static electricity that remains in the computer even after it has been powered off and the battery is removed.

For your safety, and to protect the sensitive electronic components in your computer, you must drain residual flea power before removing or replacing any components in your computer.

Draining flea power, also known as performing a "hard reset," is also a common troubleshooting step if your computer does not turn on or boot into the operating system.

Perform the following steps to drain the flea power:

Steps

1. Turn off the computer.

2. Disconnect the power adapter from the computer.
3. Remove the base cover.
4. Remove the battery.
5. Press and hold the power button for 20 seconds to drain the flea power.
6. Install the battery.
7. Install the base cover.
8. Connect the power adapter to the computer.
9. Turn on the computer.

 **NOTE:** For more information about performing a hard reset, go to [Dell Support Site](#). On the menu bar at the top of the Support page, select Support > Support Library. In the Search field on the Support Library page, type the keyword, topic, or model number, and then click or tap the search icon to view the related articles.

Getting help and contacting Dell

Self-help resources

You can get information and help on Dell products and services using these self-help resources:

Table 52. Self-help resources

Self-help resources	Resource location
Information about Dell products and services	Dell Site
Tips	
Contact Support	In Windows search, type <code>Contact Support</code> , and press Enter.
Online help for operating system	Windows Support Site Linux Support Site
Access top solutions, diagnostics, drivers and downloads, and learn more about your computer through videos, manuals, and documents.	Your Dell computer is uniquely identified using a Service Tag or Express Service Code. To view relevant support resources for your Dell computer, enter the Service Tag or Express Service Code at Dell Support Site . For more information about how to find the Service Tag for your computer, see Locate the Service Tag on your computer .
Dell knowledge base articles	<ol style="list-style-type: none"> 1. Go to Dell Support Site. 2. On the menu bar at the top of the Support page, select Support > Support Library. 3. In the Search field on the Support Library page, type the keyword, topic, or model number, and then click or tap the search icon to view the related articles.

Contacting Dell

To contact Dell for sales, technical support, or customer service issues, see [Dell Support Site](#).

 **NOTE:** Availability of the services may vary depending on the country or region, and product.

 **NOTE:** If you do not have an active Internet connection, you can find contact information about your purchase invoice, packing slip, bill, or Dell product catalog.